



PRICE LIST

October 2023

**WEST
COAST
INDUSTRIES**

Table of Contents

2	Statement of Line
7	General Information
14	Product Specifications
48	Pricing
173	Base and Top Matrix
183	Base Only Pricing
191	Top Only Pricing
199	Options Pricing
202	Power & Data

STATEMENT OF LINE – Tables

DINING & MULTIPURPOSE



Basic Round



Blok



Bolt Down



Brae



Brae Double



Canvas



Disc



Dunhill



Flat Round



Kone



Move



Parsons



Platform



Platform Double



Plus



Post Leg

STATEMENT OF LINE – Tables

DINING & MULTIPURPOSE



Regency



Tulip



Vista

OCCASIONAL

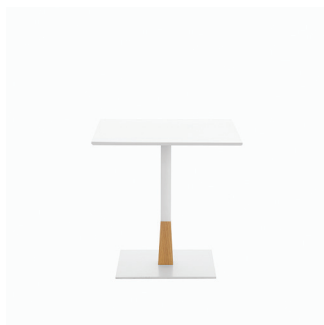

Blok



Brae



Cube



Cylinder



Disc



Kone



Move



Parsons



Platform



Triad

STATEMENT OF LINE – Tables

OUTDOOR TABLES



Basic Round



Brae



Brae Double



Disc



Flatround



Platform



Platform Double



Tulip



Vista

STATEMENT OF LINE – SEATING



Single

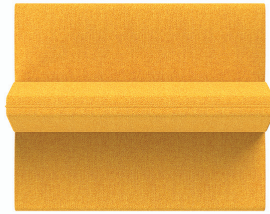

Double



U-Shape



3/4 Circle



Straight



L-Shape

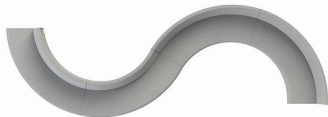

Custom Curve

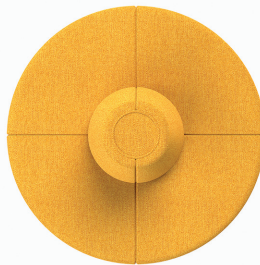

Rotunda



Ellipse



Zig



Bench



Ottoman

Custom shapes are available upon request.
Images shown are representations of WCI standard configurations.

General Information

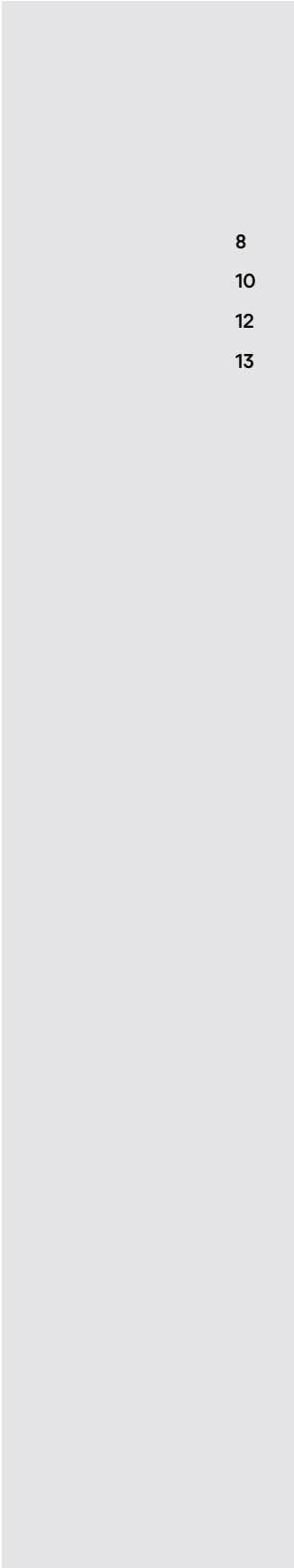

- 8 Terms and Conditions
- 10 Guaranteed Freight Program
- 12 Warranties
- 13 Care and Maintenance

GENERAL INFORMATION – *Terms and Conditions*

Prices

Possession of this price list does not in itself constitute authority to sell and/or purchase product herein. All prices are LIST prices. Prices are effective with current date printed on the cover and supersede all other price lists. All accepted orders are subject to prevailing prices at time of order. WCI reserves the right to change prices or specifications without prior notice. Prices do not include tax or installation. Additional charges may apply on special requests for inside delivery.

Minimum Order

WCI's minimum order is \$1,500 NET and orders under this amount will be subject to a \$150 service charge. .

Terms of Payment

Payment terms will be established based on the credit rating and credit information provided by and for specific customers based on their credit application. WCI accepts payment via ACH transfer, wire transfer, check, or credit card (MasterCard, VISA, or American Express) Payments made via credit card will be assessed a 3% processing fee. Orders are invoiced at the time of shipment. Standard payment terms are 50% due at the time of order and 50% before shipment. Approved credit levels may be extended to thirty (30) days. All seating orders require a 50% deposit with the order, and the balance must be paid in full prior to the date of shipment or within net thirty (30) days with established credit. Past due accounts will be charged the lesser of 1-1/2% per month or the highest rate permitted by law, plus all collection costs, including reasonable attorney's fees and expenses.

Changes or Cancellations

Any requested changes to or cancellation of an order must be submitted to WCI in writing. Approved change order requests may be subject to a revised production schedule and additional material and labor charges. Approved cancellation requests may be subject to restocking, material, and labor charges. Acknowledged orders for special, non-standard, and custom products cannot be canceled.

Storage

WCI does not have a storage space for completed orders. If customer will not accept delivery of merchandise when products are ready, WCI will transfer products to a storage facility and products will be invoiced at that time. The customer is responsible for the storage charges and assumes and all risks associated with the storage of the product. Such storage shall be deemed delivery for all purposes including invoicing and payment. Customer will be responsible for arranging transfer of the product to its final destination.

GENERAL INFORMATION – *Terms and Conditions*

Orders

All orders must include WCI product model number, final material, and finish specifications for order entry. Send your orders directly to:

Postal Service or Courier Service:

WCI
Attn: Order Entry
361 N, Bernoulli Cir,
Oxnard, CA 93030

Email:

orders@westcoastindustries.com

Duplicate orders that are received by mail (after being faxed or emailed) and not marked “confirmation” are the responsibility of the customer.

Acknowledgement

All orders are manufactured and shipped according to the acknowledgement and its terms and conditions. It is the customer’s responsibility to note any discrepancies on the acknowledgement and to notify WCI immediately. The printed acknowledgement constitutes the final agreement between the customer and WCI, thus superseding all previous communications regarding the order.

Designs and Specifications

All designs and specifications are subject to change without prior notice. Any item or material may be discontinued without prior notice. All weights and dimensions are approximate.

GENERAL INFORMATION — *Guaranteed Freight Program*

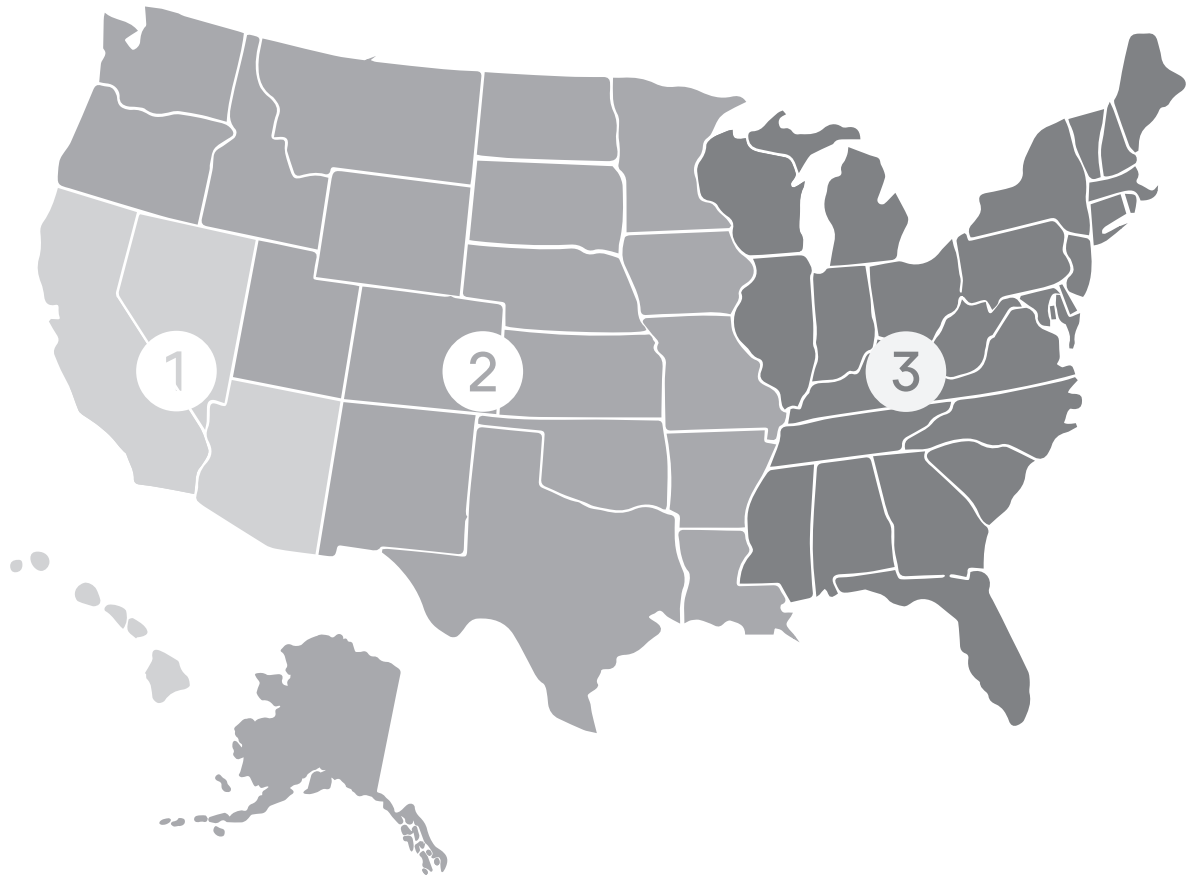

Zone 1: Add 7%

Minimum freight charge of \$150.

Arizona, California, Hawaii*, and Nevada.

Zone 2: Add 9%

Minimum freight charge of \$275.

Alaska*, Arkansas, Canada, Colorado, Idaho, Iowa, Kansas, Louisiana, Minnesota, Missouri, Montana, Nebraska, New Mexico, North Dakota, Oklahoma, Oregon, South Dakota, Texas, Utah, Washington, and Wyoming.

Zone 3: Add 11%

Minimum freight charge of \$275.

Alabama, Connecticut, Delaware, District of Columbia, Florida, Georgia, Illinois, Indiana, Kentucky, Maine, Maryland, Massachusetts, Michigan, Mississippi, New Hampshire, New Jersey, New York, North Carolina, Ohio, Pennsylvania, Rhode Island, South Carolina, Tennessee, Vermont, Virginia, West Virginia, and Wisconsin.

* Products shipped to Alaska*, Hawaii*, and Canada are F.O.B. factory, freight prepaid to port of embarkation, based on percentages as outlined above. The customer is responsible for freight charges from the port of embarkation to the final destination

Note: Guaranteed freight program applies to tables and outdoor furniture only. For upholstered furniture freight see Seating on page 13.

GENERAL INFORMATION — *Guaranteed Freight Program*

Tables and Outdoor

Tables and outdoor orders will be shipped F.O.B. factory. To calculate your guaranteed freight cost, refer to the map and zone matrix. Zone percentage is calculated based on standard discount from LIST, and pre-calculated fixed freight rate will be included on invoices. WCI reserves the absolute right to determine the method of shipping unless special delivery instructions have been previously approved. **Products shipped to Alaska*, Hawaii*, and Canada are F.O.B. factory, freight prepaid to port of embarkation, based on percentages as outlined above.** Customer is responsible for freight charges from port of embarkation to final destination

Seating

Seating is not included in WCI's guaranteed freight program. WCI will negotiate discounted freight rates on the customer's behalf and will include those rates on the invoice. Seating is shipped F.O.B. factory, un-cartoned and blanket wrapped is standard, crating maybe provided and is available upon request, an additional charge may apply. WCI reserves the absolute right to determine the method of shipping unless special delivery instructions have been previously approved. **Products shipped to Alaska*, Hawaii*, and Canada are F.O.B. factory, freight prepaid to port of embarkation, based on percentages as outlined above.** Customer is responsible for freight charges from port of embarkation to final destination

Freight Claims

West Coast Industries will file freight claims on behalf of our customer . Damage to product and or cartons MUST be noted on the proof of delivery (POD)receipt. Failure to notify or document the damage within five business days will constitute acceptance of merchandise and waiver of any defects, shortages, or errors found upon inspection. Pictures of product and or packaging must be sent to the shipping department at **213-627-1113 EX. 223** to initiate a freight claim and replacement or repair. **No claim will be accepted for concealed damage without being noted on the POD.**

Normal Delivery

Normal delivery is on a dock to dock basis. Special requests, such as inside delivery, "call before," etc, should appear on the customer's purchase order and are subject to additional charges. Every attempt will be made by WCI to accommodate customers' requests. Delivery date is subject to strikes, accidents, availability of supplies, and any other causes beyond our control. WCI may stop and/or hold shipment if payment terms, account status, or credit are not satisfactory.

Will Call

Customers may choose to pick up orders at our factory. Customers will be notified when their order is ready for orders marked "will call." Pick up must be made within five business days. If order is not picked up within five business days reference Storage policy on page 10. Customer pick up is available between 8 AM and 2 PM PST. Please call WCI customer service at **213.627.1113 ex.223** to schedule a customer pick-up.

GENERAL INFORMATION – *Warranties*

Tables

All tables manufactured by WCI are warranted to the original purchaser covering normal usage for a period of **twelve years** from the date of the original invoice. WCI will replace or repair (at our discretion) without cost to our customers any item found to be defective as a result of defective materials or workmanship. We will not, however, repair any item which has been abused or subjected to any use other than that which was originally intended for our product. Any repairs by the customer must receive specific written authorization from WCI before being executed on location to receive proper reimbursement for associated costs. In no event shall liability under this warranty exceed the original purchase price.

Electrical items not manufactured by WCI are covered for a period of one year.

Plastic laminates, Corian®, quartz and non-standard custom materials are not warranted by WCI, but are warranted by the respective manufacturers under their specific warranty only.

Wood furniture is made of natural variable raw material. Differences in grain characteristics and color among wood species are naturally occurring variations and are not within the control of WCI nor considered defects included in this warranty.

Seating

WCI seating frames are warranted to be free of defects in materials and workmanship covering normal usage to the original purchaser for a period of **seven years** from the date of the original invoice. WCI will replace or repair (at our discretion), without cost to our customers, any item found to be defective as a result of defective material or workmanship. This warranty does not apply to damage resulting from accident, misuse, abuse, alteration or negligence. Any repairs by the customer must receive specific written authorization from WCI before being executed on location to receive proper reimbursement for associated costs. WCI will not be liable for any additional charges sustained by the customer because of improper installation by others, usage or after market additions.

Plastic laminates, upholstery and non-standard custom materials are not warranted by WCI, but are warranted by the respective manufacturers under their specific warranty only.

Wood furniture is made of natural variable raw material. Differences in grain characteristics and color among wood species are naturally occurring variations and are neither within the control of WCI, nor considered defects included in this warranty.

WCI seating is not intended for outdoor usage. Outdoor usage of seating voids warranty.

COM textiles and COL leathers are not warranted by WCI, but are warranted by the respective manufacturers under their specific warranty only.

Outdoor

All outdoor products manufactured by WCI are warranted to the original purchaser covering normal usage for a period of **one year** from the date of the original invoice. WCI will replace or repair (at our discretion) without cost to our customers any item found to be defective as a result of defective material or workmanship. We will not, however, repair any item which has been abused or subjected to any use other than that which was originally intended for our product. Any repairs by the customer must receive specific written authorization from WCI before being executed on location to receive proper reimbursement for associated costs. In no event shall liability under this warranty exceed the original purchase price.

GENERAL INFORMATION – *Care and Maintenance*

Table Tops

Plastic Laminate Table Tops

Laminate topped tables be cleaned with a mild, non-abrasive cleaner and cloth.

Formica®: [www.formicadocs.info/en-us/search#sort=relevancy&f:DocumentSiteType=\[Technical%20Guides\]](http://www.formicadocs.info/en-us/search#sort=relevancy&f:DocumentSiteType=[Technical%20Guides])

Nevamar®: www.panolam.com/wp-content/uploads/2020/06/Panolam-Surface-Systems-Care-and-Maintenance-HPL-2-2018.pdf

Pionite®: www.style-ritekitchens.com/wp-content/uploads/2013/11/Pionite-Care-and-Maintenance.pdf

Wilsonart®: www.wilsonart.com/media/Technical_Resources/en/hpl_cm.pdf

Wood Veneer and Solid Wood Table Tops

Wood must be treated as a breathing, living material. Like all organisms, it is subject to changes depending upon the environment in which it exists. The principal concern is the humidity in the surrounding atmosphere and its effect on the wood. Like many other materials, wood shrinks when it loses moisture and it swells when it absorbs it. WCI wood finishes should be wiped clean with a soft damp cloth moistened with water, and then dried with a soft cloth. Wood finishes should be protected from excessive heat. A heat pad, coaster or trivet should be used to protect the table top from pots, pans, hot serving dishes, drinks, plates, etc.

Note: Do not use commercial cleaners, abrasives, solvents, Windex, 409, Ajax, etc. on the table top as this will wear away the acrylic waterborne enamel.

Corian® Table Tops

Please see: www.corian.com/IMG/pdf/k-26840-corian-solid-surface-care-and-maintenance.pdf

Quartz Table Tops

Caesarstone®: www.caesarstoneus.com/care-maintenance/quartz-surfaces/

Okite® : us.okite.com/resources/

Metal Tables Tops

All metal tables are suitable for indoor and outdoor applications. They have been pretreated and powder coat finished to resist the elements all year long without fading, rusting, or cracking.

For regular cleaning of the metal frames, use a solution of mild, non-abrasive soap and warm water. For more difficult stains, use a mild household cleaner. Avoid using abrasives and chemical cleaners. Always test a small area prior to cleaning. Do not pressure wash.

Table Bases

Powder Coat and Plated Bases

All powder coat and plated bases should be cleaned with a mild, non-abrasive cleaner and cloth. Users are urged to make periodic inspections to look for damage, loose screws and bolts, or other signs of structural fatigue incurred in daily handling, use, and abuse. Examination must include structural joints, corner blocks, welds, and any other stress points. Any product found to be damaged, defective or loose should be taken out of service immediately

General Maintenance

Our customers are urged to make periodic inspections to look for damage, loose screws and bolts or other signs of structural fatigue incurred in daily use. Examination must include structural joints, corner blocks, welds and any other stress points. Any product found to be damaged, defective or loose should be taken out of service immediately.

Product Specifications

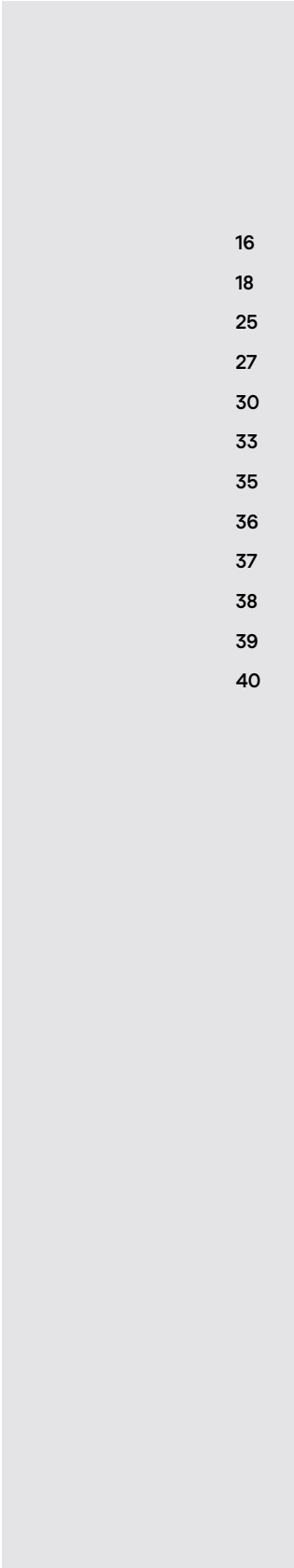

- 16 How to Order a Table
- 18 Bases Specifications
- 25 Tops Specifications
- 27 Edge Profiles
- 30 Material and Finish Codes
- 33 Laminate Reference Guide
- 35 Solid Surface Reference Guide
- 36 Quartz Reference Guide
- 37 Wood Grain and Patterns
- 38 Grommet Locations
- 39 ADA Tables
- 40 Seating Specifications

PRODUCT SPECIFICATIONS – How to Order a Table

DI36RDLWFLLDWWNMMBM This model number represents a table with a Disc series matte black powder coat base, a 36" round 1.25" thick laminate top in Designer White, with a .125" flat wood edge profile in Natural Maple.

40AH The table options specify an alternate height base with a 40" overall table height.

Table Model Number

Select your table model number which includes the base series and style, top size, top shape, top material and edge profile style and base finish.

DI36RDLWFLLDWWNMMBM

Base Series and Style Code (DI)

Disc base

Top Size Code (36)

36" diameter top

Table Shape Code (RD)

Round top

Top Material & Edge Profile Code (LWFL)

Laminate top with flat wood edge

Top Finish Code (LDW)

Laminate Designer White

Edge Finish Code (WNM)

Wood natural maple

Base Finish Code (MBM)

Matte black powder coat

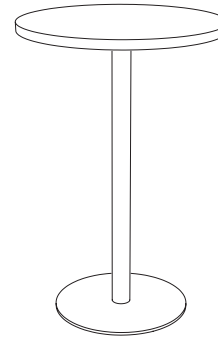
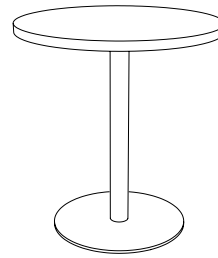

Options

Specify your options

40AH

Alternate Height (40AH)

Alternate height base (with a 40" overall table height)

PRODUCT SPECIFICATIONS – Tables

DINING & MULTIPURPOSE

BA **Basic Round**

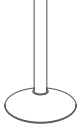

Standard Base Height: 28"
Base: 14", 17", 20", 22" & 28" diameter cast iron, also available with decorative steel cover plate for powder coating and plating.
 (L=light, M=medium, H=heavy weight)
Column: 3", 3.5" or 6" diameter, steel tubing
Top Plate: 7.625" or 15" square steel
Standard Glide: Nylon octagon (GNO)
Standard Finish: Cast iron in black texture (MBT)
Optional Finishes: Powder coated, Plated

BR **Brae**



Standard Base Height: 28"
Column: 2", 2.5" or 3" diameter, steel tubing
Top Plate: 6" SQ Flat, 10" SQ Flat & 19" Spider steel
Standard Glide: White nylon carpet glide (GNC)
Standard Finish: Powder coated
Optional Finish: Plated, Stainless Steel

BL **Blok**



Standard Base Height: 28"
Base: 18", 22", 26" in 0.375" thick square plates
Column: 2", 2.5", or 3" square steel
Wood Element: 2", 2.5" or 3" square in Oak, Walnut & Maple. Available in all 14 stains (Cherry stains are over Maple)
Top Plate: 6" SQ Flat, 10" SQ Flat & 19" Spider
Standard Glide: White nylon carpet glide (GNC)
Standard Finish: Powder Coat
Optional Finish: Plated, Stainless Steel

BRD **Brae Double**

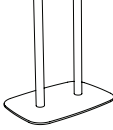

Standard Base Height: 28"
Base: 18" x 26" .375" thick steel plate
Column: 2" round steel tubing
Top Plate: 10" SQ Flat
Standard Glide: White nylon carpet glide (GNC)
Standard Finish: Powder coated
Optional Finish: Plated, Stainless Steel

JB **Bolt Down**

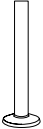

(JB) J Bolt-down Base
Standard Base Height: 28"
Floor Plate: 6.75" diameter steel with four .375" diameter holes; fasteners to attach base to floor are not included.
Cover Plate: 8" diameter steel, finish to match column
Column: 3" diameter, steel tubing
Top Plate: 7.625" square steel
Standard Finish: Powder coated
Optional Finish: Plated

CA **Canvas**



Overall Table Height: 29"
Legs: 2.5" x 2.5" plywood
Apron: 2.5" high
Legs & Apron: Laminate or wood veneer
Top: Laminate or wood veneer
Overlay: 3form® Chroma®, Corian®, Quartz Clad: Corian®
Standard Glide: Nickel plated glide (GNP)

All table bases are assembled, level checked, and cartoned. Vista table collection is shipped KD.

PRODUCT SPECIFICATIONS – Tables

DINING & MULTIPURPOSE

DI

Disc

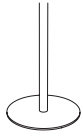

Standard Base Height: 28"
Base: 18", 22" & 26" diameter .375" thick steel plate
Column: 2", 2.5" or 3" diameter, steel tubing
Top Plate: 6" SQ Flat, 10" SQ Flat & 19" Spider steel
Standard Glide: White nylon carpet glide (GNC)
Standard Finish: Powder coated
Optional Finish: Plated, Stainless Steel

KO

Kone

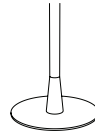

Standard Base Height: 28"
Base: 18", 22", 26" 0.375" thick round plates
Column: 2", 2.5" or, 3" round Steel
Wood Element: 2", 2.5" or 3" round in Oak, Walnut & Maple. Available in all 14 stains (Cherry stains are over Maple)
Top Plate: 6" SQ Flat, 10" SQ Flat & 19" Spider
Standard Glide: White nylon carpet glide (GNC)
Standard Finish: Powder Coat
Optional Finish: Plated, Stainless Steel

DU

Dunhill

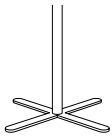

Standard Base Height: 28"
Base: 18", 24", 30" & 36" X-base configurations, 18", 24" & 30" T-base configurations with a single column. Double column T-bases are available 30" or 36" wide, .5" x 2.5" solid steel bar
Column: 2", 2.25", 3" or 3.25" diameter, steel tubing
Top Plate: 7.625", 10.75" or 15" square steel
Standard Glide: Nylon octagon (GNO)
Standard Finish: Powder coated
Optional Finish: Plated, Stainless Steel

MOV

Move



Overall Table Height: 25"
Dimensions: 18" Depth, 13" Width, 15" Width
Top: Laminate (available in 7 finishes) or wood veneer
Standard Glide: 2.25" Round Teflon Glide
Standard Finish: Powder coated
Optional Finish: Plated (polished not available)

FR

Flat Round

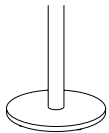

Standard Base Height: 28"
Base: 18", 22" & 26" diameter cast iron with decorative steel cover plate
Column: 3", 3.5" or 6" diameter, steel tubing
Top Plate: 7.625", 10.75" or 15" square steel
Standard Glide: Nylon octagon (GNO)
Standard Finish: Powder coated
Optional Finish: Plated, Stainless Steel

PA

Parsons

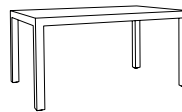

Overall Table Height: 29"
Legs: 2.5" x 2.5" solid lumber
Apron: 2.5" high
Legs & Apron: Laminate or wood
Top: Laminate or wood veneer
Standard Glide: Nickel plated glide (GNP)

All table bases are assembled, level checked, and cartoned. Vista table collection is shipped KD.

PRODUCT SPECIFICATIONS – Tables

DINING & MULTIPURPOSE

PL Platform

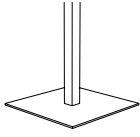

Standard Base Height: 28"
Base: 18", 22" & 26" square .375" thick steel plate
Column: 2" SQ, 2.5" SQ or 3" SQ steel tubing
Top Plate: 6" SQ Flat, 10" SQ Flat & 19" Spider steel
Standard Glide: White nylon carpet glide (GNC)
Standard Finish: Powder coated
Optional Finish: Plated, Stainless Steel

PO Post Leg



Standard Base Height: 28"
Leg: 1.5", 2.5" or 3" diameter steel tubing
Top Plate: 4.25" or 6" square steel
Standard Glide: Nickel plated with white nylon bottom (GNN)
Standard Finish: Powder coated
Optional Finish: Plated

PLD Platform Double

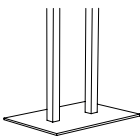

Standard Base Height: 28"
Base: 18" x 26" .375" thick steel plate
Column: 2" square steel tubing
Top Plate: 10" SQ Flat
Standard Glide: White nylon carpet glide (GNC)
Standard Finish: Powder coated
Optional Finish: Plated, Stainless Steel

RG Regency

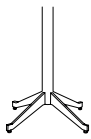

Standard Base Height: 28"
Base: 18", 24", 30" X-base configurations, .5" solid steel, tapering from 2.5" high to 1.25" high. 36" & 48" X-base configurations, 1" solid steel, tapering from 3" high to 1.25" high. 21" x 42" & 24" x 48" scissor-base configurations, 1" solid steel, tapering from 3" high to 1.25" high.
Column: 2.5" or 3.5" diameter steel tubing
Top Plate: 7.625" or 15" square steel, 15" x 24" & 18" x 36" flat iron
Standard Glide: Nickel plated glide (GNP)
Standard Finish: Powder coated
Optional Finish: Plated

PU Plus

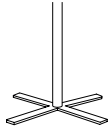

Standard Base Height: 28"
Base: 18", 24", 30" & 36" X-base configurations, 18", 24" & 30" T-base configurations with a single column. Double column T-bases are available 30" or 36" wide, .5" x 2.5" solid steel bar
Column: 2", 2.25", 3" or 3.25" diameter, steel tubing
Top Plate: 7.625", 10.75" or 15" square steel
Standard Glide: Nylon octagon (GNO)
Standard Finish: Powder coated
Optional Finish: Plated, Stainless Steel

TL Tulip

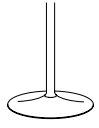

Standard Base Height: 28"
Base: 18" or 24" diameter (L=light, M=medium, H=heavy, XH=extra heavy weight) cast iron with decorative steel cover plate.
Column: 2" or 2.25" diameter, steel tubing
Top Plate: 7.625", 10.75" or 15" square steel
Standard Glide: Nylon Octagon (GNO)
Standard Finish: Powder coated
Optional Finish: Plated, Stainless Steel

VS Vista



Overall Table Heights: 29", 36" & 42"
Legs: 2" x 2.5" Square steel tubing
Top: Laminate, wood veneer, 3form® Chroma®, Corian®, Quartz
Glide: Nickel plated glide (GNP)

All table bases are assembled, level checked, and cartoned. Vista table collection is shipped KD.

PRODUCT SPECIFICATIONS – Tables

OCCASIONAL

BL

Blok

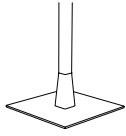

Standard Base Height: 16", 18", 20"
Base: 14" in 0.25" thick & 18", 22" in 0.375" thick square plates
Column: 1.5", 2" square steel
Wood Element: 1.5", 2" square in Oak, Walnut & Maple. Available in all 14 stains (Cherry Stains over Maple)
Top Plate: 6", 10" SQ Flat
Standard Glides: 2.25" Round Teflon Glide or Carpet Glides (GNC)
Standard Finish: Powder Coat
Optional Finish: Plated, Stainless Steel

CY

Cylinder

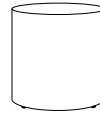

Overall Table Heights: 16", 18", 20" & 24"
Material: Laminate or wood construction
Overlay: Corian® & Quartz
Standard Glide: Nickel plated glide (GNP)

BR

Brae

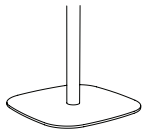

Occasional Base Heights: 16", 18" or 20"
Base: 18" & 22" diameter .375" thick steel plate
Column: 1.5", 2" diameter, steel tubing
Top Plate: 6" SQ Flat, 10" SQ Flat steel
Standard Glide: White nylon carpet glide (GNC)
Standard Finish: Powder coated
Optional Finish: Plated, Stainless Steel

DI

Disc

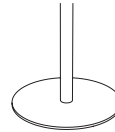

Occasional Base Heights: 16", 18" or 20"
Base: 18" & 22" diameter .375" thick steel plate
Column: 1.5", 2" diameter, steel tubing
Top Plate: 6" SQ Flat, 10" SQ Flat steel
Standard Glide: White nylon carpet glide (GNC)
Standard Finish: Powder coated
Optional Finish: Plated, Stainless Steel

CU

Cube

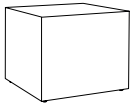

Overall Table Heights: 16", 18", 20" & 24"
Material: Laminate or wood construction
Overlay: Corian® & Quartz
Standard Glide: Nickel plated glide (GNP)

All table bases are assembled, level checked, and cartoned. Vista table collection is shipped KD.

PRODUCT SPECIFICATIONS – Tables

OCCASIONAL

KO

Kone

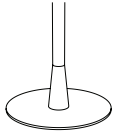

Occasional Base Heights: 16", 18", 20"
Base: 14" in 0.25" thick & 18", 22" in 0.375" thick round plates
Column: 1.5", 2" round steel
Wood Element: 1.5", 2" round in Oak, Walnut & Maple. Available in all 14 stains (Cherry Stains over Maple)
Top Plate: 6", 10" SQ Flat
Standard Glide: 2.25" Round Teflon Glide or Carpet Glides (GNC)
Standard Finish: Powder Coat
Optional Finish: Plated, Stainless Steel

PL

Platform

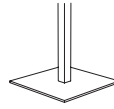

Occasional Base Heights: 16", 18" or 20"
Base: 18" & 22" square .375" thick steel plate
Column: 1.5" SQ or 2" SQ steel tubing
Top Plate: 6" SQ Flat, 10" SQ Flat steel
Standard Glide: White nylon carpet glide (GNC)
Standard Finish: Powder coated
Optional Finish: Plated, Stainless Steel

MOV

Move



Overall Table Height: 25"
Dimensions: 18" Depth, 13" Width, 15" Width
Top: Laminate, wood veneer, Corian®
Standard Glide: 2.25" Round Teflon Glide
Standard Finish: Powder coated
Optional Finish: Plated (polished not available)

TR

Triad



Occasional Base Heights: 16", 18" or 20"
Base: Ash solid lumber
Top: Laminate, wood veneer, Corian®
Standard Glide: .75" round nail on Nylon carpet glide
Standard Finish: Powder coated
Optional Finish: Plated, Stainless Steel

PA

Parsons

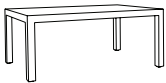

Overall Occasional Table Heights: 16", 18", 20", 24"
Legs: 2.5" x 2.5" solid lumber
Apron: 2.5" high
Material: Laminate or wood construction
Standard Glide: Nickel plated glide (GNP)

All table bases are assembled, level checked, and cartoned. Vista table collection is shipped KD.

PRODUCT SPECIFICATIONS – Tables

OUTDOOR TABLES

BA **Basic Round**

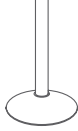

Standard Base Height: 28"
Base: 14", 17", 20", 22" & 28" diameter cast iron, also available with decorative steel cover plate for powder coating (L=light, M=medium, H=heavy weight)
Column: 3", 3.5" or 6" diameter, steel tubing
Top Plate: 7.625" or 15" square steel
Standard Glide: Superlevel glide (GSL)
Standard Finish: Cast iron in black texture (MBT)
Optional Finish: Powder coated

FR **Flat Round**

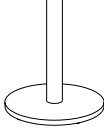

Standard Base Height: 28"
Base: 18", 22" & 26" diameter cast iron with decorative aluminum cover plate
Column: 3" or 6" diameter, aluminum tubing
Top Plate: 7.625", 10.75" or 15" square steel
Standard Glide: Superlevel glide (GSL)
Standard Finish: Powder coated
Optional Finish: Anodized Aluminum, Stainless Steel

BR **Brae**

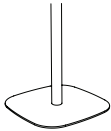

Standard Base Height: 28"
Base: 18", 22" & 26" RD square .375" thick steel plate
Column: 2", 2.5" or 3" diameter, steel tubing
Top Plate: 6" SQ Flat, 10" SQ Flat, & 19" Spider steel
Standard Glide: Nylon octagon (GNO)
Standard Finish: Powder coated
Optional Finish: Stainless Steel

PL **Platform**



Standard Base Height: 28"
Base: 18", 22" & 26" square .375" thick steel plate
Column: 2" SQ, 2.5" SQ or 3" SQ steel tubing
Top Plate: 6" SQ Flat, 10" SQ Flat & 19" Spider steel
Standard Glide: Black octagon (GNO)
Standard Finish: Powder coated
Optional Finish: Stainless Steel

DI **Disc**

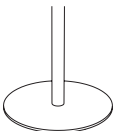

Standard Base Height: 28"
Base: 18", 22" & 26" diameter .375" thick steel plate
Column: 2", 2.5" or 3" diameter, steel tubing
Top Plate: 6" SQ Flat, 10" SQ Flat, & 19" Spider steel
Standard Glide: Nylon octagon (GNO)
Standard Finish: Powder coated
Optional Finish: Stainless Steel

PLD **Platform Double**

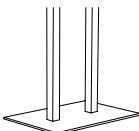

Standard Base Height: 28"
Base: 18" x 26" .375" thick steel plate
Column: 2" square steel tubing
Top Plate: 10" SQ Flat
Standard Glide: Black octagon (GNO)
Standard Finish: Powder coated
Optional Finish: Stainless Steel

BRD **Brae Double**

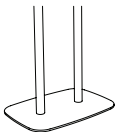

Standard Base Height: 28"
Base: 18" x 26" .375" thick steel plate
Column: 2" diameter, steel tubing
Top Plate: 10" SQ Flat
Standard Glide: Nylon octagon (GNO)
Standard Finish: Powder coated
Optional Finish: Stainless Steel

All table bases are assembled, level checked, and cartoned. Vista table collection is shipped KD.

PRODUCT SPECIFICATIONS – Tables

OUTDOOR TABLES

VS

Vista



Overall Table Heights: 29", 36" & 42"
Legs: 2" or 2.5" square steel tubing
Top: Laminate, wood veneer, Corian®, Quartz
Standard Glide: Nickel plated glide (GNP)

TL

Tulip

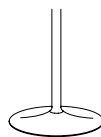

Standard Base Height: 28"
Base: 18" or 24" diameter (L=light, M=medium, H=heavy, XH= extra heavy weight) cast iron with decorative steel cover plate
Column: 2" or 2.25" diameter, steel tubing
Top Plate: 7.625", 10.75" or 15" square steel
Standard Glide: Superlevel glide (GSL)
Standard Finish: Powder coated
Optional Finish: Stainless Steel

All table bases are assembled, level checked, and cartoned. Vista table collection is shipped KD.

PRODUCT SPECIFICATIONS – *Tops*

Laminate Top Construction

Standard 1.25" thick core material, consisting of a NAUF Particle Board (45.5 lb/ft³), MDF (46 lb/ft³), or 1" thick Birch Plywood (40 lb/ft³) core, surfaced with a laminate face. The core material is determined by the specified edge profile. A phenolic backer is used on the underside of the top. All complete tables (consisting of a top and base) have steel threaded inserts for metal-to-metal mounting of the top to the base, allowing ease of installation. Tops sold separately do not have steel threaded inserts. Table tops over 96" in length have steel support to prevent bowing. All top dimensions are nominal and may vary up to 0.75", depending on the edge treatment. If a critical size is required (± 0.0625 "), dimensions should be specified in writing.

Wood Veneer Top Construction

Standard 1.25" thick core material, consisting of a NAUF Particle Board (45.5 lb/ft³), MDF (46 lb/ft³), or 1" thick Birch Plywood (40 lb/ft³) core, surfaced with a book matched veneer face. A phenolic backer is used on the underside of the top. All complete tables (consisting of a top and base) have steel threaded inserts for metal-to-metal mounting of the top to the base, allowing ease of installation. Tops sold separately do not have steel threaded inserts. Table tops over 96" in length have steel support to prevent bowing. All top dimensions are nominal and may vary up to 0.75", depending on the edge treatment. If a critical size is required (± 0.0625 "), dimensions should be specified in writing.

Butcherblock Top

Butcher Block Tops have an eased edge with 1-5/16" (1.3125") to 1-11/16" (1.6875") wide finger jointed strips, and are 10" to 24" long. Tops are 1.375" thick and 1.875" thick on 60" and 72" tops. Tops are constructed from solid maple and have 0.75" tolerance.

Wood Surface Finish

All wood products are finished in acrylic waterborne enamel providing a 10-20% sheen finish using a multi-step process of hand sanding, staining, and sealing that provides superior water and alcohol resistance. Custom sheens are available upon request; please contact WCI Customer Service for a quote.

Solid Surface

Corian® Surfaces

Standard 1"x1" thick built-up edge on 0.5" thick Corian® (106.1 lb/ft³) with a wood sub-top. Fabricated out of a 0.75" plywood sub-top for indoor and outdoor use, finished in standard white paint. Corian® is a solid surface material from DuPont composed of 33% of Poly Methyl Methacrylate and 67% of Natural Minerals like Alumina Trihydrate. Corian®, along with its adhesives and sealants, are certified by GREENGUARD®, providing a complete surfacing system with low amounts of VOC (volatile organic compounds). All top dimensions are nominal and may vary up to 0.75" depending on the edge treatment. If a critical size is required (± 0.0625 "), dimensions must be specified in writing.

Quartz Surfaces

Standard 0.75" thick material construction with 0.75" marine grade plywood sub-top for indoor use only. Quartz is comprised of a blend of 93% quartz and 7% polyester that is processed into slabs using a vibro-compression vacuum process. If your project entails more material than a manufactured slab, one or more seams will be required. The product is certified according to the GREENGUARD® Indoor Air Quality Certification Program for Low Emitting Products. As a non-porous material, it will not harbor bacteria and is stain resistant. It is very dense, making it impact and scratch resistant. The sub-top is painted to match the quartz top and is sized such that it is inset by 3" from the edge of the top. All top dimensions are nominal and may vary up to 0.75" depending on edge treatment. If a critical size is required (± 0.125 "), dimensions should be specified in writing.

PRODUCT SPECIFICATIONS – *Tops*

Vinyl T-Mold Edges

Vinyl edges provide an impact-resistant edge. All vinyl T-molding corners have a 2" radius.

PVC Edges

PVC edges provide an impact-resistant edge. PVC corners are 90° square, rounded corners are a 3" radius minimum.

Wood Edges

Wood edges are offered in solid ash, maple, rift cut oak, cherry, and walnut. Other wood species are available upon request; please contact WCI Customer Service for a quote.

Overall Table Heights

Overall table heights vary according to top specification. WCI's standard base only height is 28" . Add top thickness to determine overall table height. Canvas and Parsons are standard at 29 overall height. For alternate height (AH) tables, the height specification refers to the overall height of the table when ordering a complete table, or the overall height of the base when ordering base only.

PRODUCT SPECIFICATIONS – Edge Profiles

SELF EDGE

LLSE

Self Laminate Edge

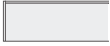

1.25" thick edge
Edge is banded with matching standard grade top plastic laminate
Square and rectangle tops standard with square corners
Available on 1.25" thick top
Available in 19 standard laminates

VINYL EDGES

LVFL

Flat Vinyl T-Mold Edge

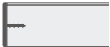

.125" x 1.25" flat vinyl edge
Square and rectangle tops standard with 2" radius corners
Available on 1.25" thick top
Available in 12 colors

LVBP

Bumper Vinyl T-Mold Edge

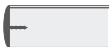

.1875" x 1.25" rounded vinyl bumper edge
Square and rectangle tops standard with 2" radius corners
Available on 1.25" thick top
Available in 12 colors

PVC EDGE

LPVC

Flat PVC Edge



.125" x 1.25" flat pvc edge
Square and rectangle tops standard with square corners Available on 1.25" thick top
Available in 12 colors

WOOD EDGES GROUP A

LW = Laminate top with a wood edge available in 19 standard laminates
WW = Wood top with a wood edge available in 5 wood species and 20 stains

LWFL & WWFL

Flat Wood Edge



.125" thick flat wood edge, eased corners
Square and rectangle tops standard with square corners
Available on 1.25" thick top
Available in 5 wood species and 20 stains

LWTP & WWTP

Tapered Ply Edge



1" thick exposed Baltic Birch plywood edge with a reverse beveled tapered profile
Square and rectangle tops standard with square corners
Available on 1" thick top

LWFP & WWFP

Flat Ply Edge



1" thick exposed Baltic Birch plywood edge with a flat profile
Square and rectangle tops standard with square corners
Available on 1" thick top

WOOD EDGES GROUP B

LW = Laminate top with a wood edge available in 19 standard laminates
WW = Wood top with a wood edge available in 5 wood species and 20 stains

LWSQ & WWSQ

Square Wood Edge



1.25" x 1.25" flat square wood edge
Square and rectangle tops standard with square corners
Available on 1.25" thick top
Available in 5 wood species and 20 stains

LWBN & WWBN

Bullnose Wood Edge



1.25" x 1.25" bullnose wood edge
Square and rectangle tops standard with square corners Available on 1.25" thick top
Available in 5 wood species and 20 stains

LWPR & WWPR

Prism Wood Edge



1.25" x 1.25" prism wood edge
Square and rectangle tops standard with square corners
Available on 1.25" thick top
Available in 5 wood species and 20 stains

PRODUCT SPECIFICATIONS – Edge Profiles

BUTCHER BLOCK EDGES

BBFL

Butcher Block Flat Edge



1.3125" finger jointed strips x 1.375" thick, 1.875" thick on 60" diameter tops only
Square and rectangle tops standard with square corners
Available on 1.375" thick top
Available in Maple and 3 stains

BBBN

Butcher Block Bullnose Edge



1.3125" finger jointed strips x 1.375" thick, 1.875" thick on 60" diameter tops only
Square and rectangle tops standard with .5" radius corners
Available on 1.375" thick top
Available in Maple and 3 stains

CORIAN® EDGES

COFL

Corian® Flat Edge



.5" thick Corian® material with 1" thick edge
Square and rectangle tops standard with .125" radius corners
Available in 8 colors

COBN

Corian® Bullnose Edge



.5" thick Corian® material with 1" thick edge
Square and rectangle tops standard with .5" radius corners
Available in 8 colors

COPR

Corian® Prism Edge



.5" thick Corian® material with 1" thick edge
Square and rectangle tops standard with square corners
Available in 8 colors

QUARTZ EDGES

Q1FL & Q2FL

Quartz Flat Edge



.75" thick material
With .75" painted plywood subtop, 3" inset from edge
Square and rectangle tops with standard square corners
Available in 7 colors

Q1BN & Q2BN

Quartz Bullnose Edge



.75" thick material
With .75" painted plywood subtop, 3" inset from edge
Square and rectangle tops with standard square corners
Available in 7 colors

FACET EDGES – BLOK & KONE TABLES

LFSE

Facet Self Edge



1.25" thick facet edge
Square and rectangle tops with standard square corners
Available on 1.25" thick top
Available in 19 standard laminates

WVFC

Veneer Facet Self Edge



1.25" thick facet edge
Square and rectangle tops with standard square corners
Available on 1.25" thick top
Available in 5 wood species and 20 stains

WWFC

Wood Facet Edge



1.25" x 1.25" thick facet wood edge
Square and rectangle tops with standard square corners
Available in 1.25" thick tops
Available in 5 wood species and 20 stains

COFC





Corian® Facet Edge



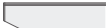

.5" Corian® with 1" thick edge
Square and rectangle tops with standard square corners
Available on 1" thick top
Available in 8 finishes

PRODUCT SPECIFICATIONS – Edge Profiles



OCCASIONAL TABLES – FACET EDGES

LFCT	Facet Ply Edge
	<p>1" thick facet edge Square and rectangle tops with standard square corners Available on 1" thick top Available in 19 standard laminates</p>
LMFC	Mini-Facet Ply Edge
	<p>.5" thick facet edge Square tops with standard square corners Available in .5" thick top Available in 19 laminate finishes</p>
WFCT	Veneer Occasional Facet Edge
	<p>1" thick facet edge Square and rectangle tops with standard square corners Available on 1" thick top Available in 5 wood species and 20 stains</p>
WMFC	Mini Veneer Facet Self Edge
	<p>.5" thick wood edge Square and rectangle tops with standard square corners Available in 5 wood species and 20 stains</p>
COFM	Mini Corian® Facet Edge
	<p>.5" Corian® with .5" thick edge Square tops with standard square corners Available on .5" thick top Available in 8 finishes</p>

MOVE TABLE EDGES

LMOV	Ply Move Edge
	<p>.5" thick exposed Baltic Birch plywood edge Standard with .63" radius corners</p>
WMOV	Veneer Move Edge
	<p>.5" thick wood edge Standard with .63" radius corners Available in 5 wood species and 20 stains</p>
CMOV	Corian® Move Edge
	<p>.5" thick Corian® material Standard with .63" radius corners Available in 8 standard colors</p>

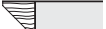
TRIAD TABLE EDGES

WWTR	Triad Prism Edge
	<p>1" x 1" prism wood edge Available on 1" thick top Available in Ash and 6 stains</p>
COPR	Corian® Prism Edge
	<p>.5" thick Corian® material with 1" edge Square and rectangle tops standard with square corners Available in 8 standard colors</p>

PRODUCT SPECIFICATIONS – Material and Finish Codes

BASE FINISHES

Powder Coat

Solids

MWM	Matte White
MWG	Gloss White
MLG	Light Grey
MMG	Medium Grey
MBM	Matte Black
MBG	Gloss Black

Metallics

MSL	Silver
MDB	Dark Bronze

Textures

MWT	White Texture
MRB	Rubbed Bronze
MBT	Black Texture

Plated

Standards

MSC	Satin Chrome
MPC	Polished Chrome

Premiums

MSB	Satin Brass
MPB	Polished Brass
MAB	Antique Brass
MBB	Blackened Brass
MSO	Satin Copper
MPO	Polished Copper
MSZ	Statuary Bronze

Aluminum

MSA	Satin Aluminum
MPA	Polished Aluminum

Stainless Steel

MSS	Satin Stainless Steel
MPS	Polished Stainless Steel

Custom

CPC	Custom Powder Coat
------------	--------------------

SURFACE MATERIALS

Laminate (Surface and Self Edge)

Solids

LDV	Dover White
LDW	Designer White
LFG	Fashion Grey
LMS	Mouse
LJB	Jett Black

Wood Looks

LHL	High Line
LPE	Park Elm
LAL	Appears Likeatre
LLT	Looks Likeatre
LAE	5th Ave. Elm
LST	Studio Teak
LSB	Sable

Patterns

LCC	Cool Chic
LSS	Serene Stardom
LCD	Calm Distinction
LEE	Easy Elegance

Metal Looks

LPS	Pearl Silver
LSO	Satin Oxide
LSA	Silver Alu Metalx

See WCI Laminate Reference Guide, page 30 for additional information

Wood Veneer

Ash

WCA	Clear Ash
WNA	Natural Ash
WTA	Taupe Ash
WAA	Amber Ash
WWA	Walnut Ash
WDA	Dark Ash

Rift Cut Oak

WNO	Natural Rift Oak
WMO	Medium Rift Oak
WDO	Dark Rift Oak
WEO	Ebony Rift Oak

Maple

WNM	Natural Maple
WGM	Golden Maple
WDM	Dark Maple

Walnut

WNW	Natural Walnut
WMW	Medium Walnut
WDW	Dark Walnut

Cherry

WNC	Natural Cherry
WMC	Medium Cherry
WDC	Dark Cherry
WMA	Mahogany Over Cherry

Natural variations in color, grain, texture and finish may occur depending on the WCI material specified.

PRODUCT SPECIFICATIONS – *Material and Finish Codes*

SURFACE MATERIALS

Solid Wood

Butcher Block

BNM	Natural Maple
BNC	Natural Cherry Over Maple
BMA	Mahogany Over Maple

See Solid Surface Reference Guide, page 35 for additional information

Corian®

Solids

CDW	Designer White
CGW	Glacier White
CSG	Silver Gray
CDS	Deep Sable

Patterns

CRC	Rain Cloud
CNS	Deep Night Sky
CLN	Linen
CDM	Deep Mink

See Solid Surface Reference Guide, page 35 for additional information

Quartz*

Caesarstone® (Q1)

QOF	Ocean Foam
QPB	Pebble
QCT	Concrete
QRV	Raven

Okite® (Q2)

QBA	Bianco Assoluto
QBC	Bianco Carrara
QNR	Nero Reale

See Quartz Reference Guide, page 36 for additional information

*Available on select tables only.

Natural variations in color, grain, texture and finish may occur depending on the WCI material specified.

PRODUCT SPECIFICATIONS – Material and Finish Codes

EDGE MATERIALS

Laminate

Solids

LDV	Dover White
LDW	Designer White
LFG	Fashion Grey
LMS	Mouse
LJB	Jett Black

Wood Looks

LHL	High Line
LPE	Park Elm
LAL	Appears Likeatre
LLT	Looks Likeatre
LAE	5th Ave. Elm
LST	Studio Teak
LSB	Sable

Patterns

LCC	Cool Chic
LSS	Serene Stardom
LCD	Calm Distinction
LEE	Easy Elegance

Metal Looks

LPS	Pearl Silver
LSO	Satin Oxide
LSA	Silver Alu Metalx

Vinyl & PVC

VFW	Frosty White
VSR	Surf
VPD	Pepperdust
VTN	Tan
VGY	Grey
VWH	Designer White
VFG	Fashion Grey
VFO	Fog
VNS	North Sea
VGP	Graphite
VSG	Slate Grey
VBK	Black

Wood

Rift Cut Oak

WNO	Natural Rift Oak
WMO	Medium Rift Oak
WDO	Dark Rift Oak
WEO	Ebony Rift Oak

Maple

WNM	Natural Maple
WGM	Golden Maple
WDM	Dark Maple

Walnut

WNW	Natural Walnut
WMW	Medium Walnut
WDW	Dark Walnut

Cherry

WNC	Natural Cherry
WMC	Medium Cherry
WDC	Dark Cherry
WMA	Mahogany Over Cherry

Chair Materials

Polypropylene (Seat and Back)

PWH	White
-----	-------

Synthetic Rattan

RHN	Honey
RBK	Black

Chair Frame Finishes

Powder Coat

Metallics	
MSL	Silver

Aluminum

MPA	Polished Aluminum
-----	-------------------

Natural variations in color, grain, texture and finish may occur depending on the WCI material specified.

PRODUCT SPECIFICATIONS – Laminate Reference Guide

WCI's standard laminate palette offers 19 solid, wood look, patterned, and metal look laminates all of which are available at standard pricing and lead times.

Materials	Manufacturer Code	Manufacturer Name	WCI Code
Solids			
Formica	7197-58	Dover White	LDV
Wilsonart	D354-60	Designer White	LDW
Wilsonart	D381-60	Fashion Grey	LFG
Formica	928-58	Mouse	LMS
Nevamar	S6053T	Jett Black	LJB
Wood Looks			
Wilsonart	7970K-18	High Line	LHL
Wilsonart	7967K-12	Park Elm	LPE
Pionite	WP115	Appears Likeatre	LAL
Pionite	WP110	Looks Likeatre	LLT
Wilsonart	7966K-12	5th Ave. Elm	LAE
Wilsonart	7960K-18	Studio Teak	LST
Pionite	AG021	Sable	LSB
Patterns			
Nevamar	VA7002T	Cool Chic	LCC
Nevamar	VA5001T	Serene Stardom	LSS
Nevamar	VA6001T	Calm Distinction	LCD
Nevamar	VA5002T	Easy Elegance	LEE
Metal Looks			
Wilsonart	D487-07	Pearl Silver	LPS
Wilsonart	4832K-07	Satin Oxide	LSO
Nevamar	MXT003T	Silver Alu Metalx	LSA

Standard Laminates: WCI offers 19 standard laminates including: Formica, Nevamar, Pionite, and Wilsonart. To see an expanded offering, please visit the laminate manufacturers' websites at:

formica.com
 nevamar.com
 pionite.com
 wilsonart.com

Non-standard laminates from Formica, Nevamar, Pionite, and Wilsonart are also available. Non-standard WCI laminates will incur a minimum of 150 list set-up charge per laminate color. Please contact WCI Customer Service at 844-815-2217 for all special laminate requests.

Premium Laminates: Other laminates from these manufacturers or laminates from other manufacturers are available, such as Arborite®, Laminart®, and Abet Laminati®. These require a special pricing; please contact WCI's Customer Service Department at 844-815-2217 for all special laminate requests.

PRODUCT SPECIFICATIONS – Laminate Reference Guide

	Standard Laminates				Vinyl/PVC Edges											
	Manufacturer	Manufacturer Code	WCI Code	Name	VFW Frosty White	VSR Surf	VPD Pepperdust	VTN Tan	VGY Grey	VWH DesignerWhite	VFG Fashion Grey	VFO Fog	VNS North Sea	VGP Graphite	VSG Slate Grey	VBK Black
Solids	Formica	7197-58	LDV	Dover White	P											
	Wilsonart	D354-60	LDW	Designer White						P						
	Wilsonart	D381-60	LFG	Fashion Grey							P					
	Formica	928-58	LMS	Mouse									P			
	Nevamar	S6053-T	LJB	Jett Black												P
Wood Looks	Wilsonart	7970K-18	LHL	High Line				P								
	Wilsonart	7967K-12	LPE	Park Elm				P								
	Pionite	WP115	LAL	Appears Likeatre				P								
	Pionite	WP110	LLT	Looks Likeatre			P		C							
	Wilsonart	7966K-12	LAE	5th Ave. Elm					P							
	Wilsonart	7960K-18	LST	Studio Teak											P	
	Pionite	AG021	LSB	Sable										P		C
Patterns	Nevamar	VA7002T	LCC	Cool Chic		P										
	Nevamar	VA5001T	LSS	Serene Stardom									P			
	Nevamar	VA6001T	LCD	Calm Distinction									P			
	Nevamar	VA5002T	LEE	Easy Elegance										C	P	C
Metal Looks	Wilsonart	D487--07	LPS	Pearl Silver							P					
	Wilsonart	4832K-07	LSO	Satin Oxide			P					C				
	Nevamar	MXT003T	LSA	Silver Alu Metalx								P	C			

P : Primary Match (recommended)
 C : Compatible Match (alternative)

PRODUCT SPECIFICATIONS – *Solid Surface Reference Guide*

Corian®

Corian® is a solid surface material created by DuPont, composed of acrylic polymer and alumina trihydrate. Corian® is available in a vast range of trendsetting patterns and tones.

WCI Corian® Standard Colors	WCI Code
Designer White	CDW
Silver Gray	CSG
Rain Cloud	CRC
Deep Night Sky	CNS
Glacier White	CGW
Linen	CLN
Deep Mink	CDM
Deep Sable	CDS

Corian® tops are not sold separately as a standard product. All top-only requests must be processed as a custom product. Steel sub-frames are designed to fit only WCI's standard bases. A minimum of five Corian® tops, per color, is required for non-standard Corian® top orders. To see an expanded offering, please visit Corian's website: www.dupont.com

PRODUCT SPECIFICATIONS – Quartz Reference Guide

Caesarstone® Quartz and Okite® Quartz

Engineered stone tops offer one of the most durable stone composite surfaces. They are one of the toughest yet most beautiful of all minerals and have the look and feel of stone offering a more non-porous, scratch-resistant, stain-resistant and heat-resistant properties.

Q1

WCI Ceasarstone® Standard Colors	Manufacturer Code	WCI Code
Ocean Foam	6141	QQF
Pebble	4030	QPB
Concrete	2003	QCO
Raven	4120	QRV

Q2

WCI Okite® Standard Colors	Manufacturer Code	WCI Code
Bianco Assoluto	1665	QBA
Bianco Carrara	1896	QBC
Nero Reale	1804	QNR

Quartz tops are not sold separately as a standard product. The material is only available for the following tables:

Basic Round
Blok
Brae
Brae Double
Canvas
Cube
Cylinder
Disc
Flat Round
Kone
Parsons
Platform
Platform Double
Regency
Tulip
Vista

Our standard quartz top offering features Okite® and Caesarstone® and is composed of up to 93% natural quartz and polymer resin.

To see an expanded offering, please visit the manufacturers' websites.

Caesarstone®: caesarstoneus.com/products

Okite®: okite.com/us/prodotti

A minimum of five quartz tops, per color, is required for non-standard quartz top orders.

PRODUCT SPECIFICATIONS – Wood Grains, Patterns, and Stain-to-Match

WCI wood veneer is book matched as standard.

For custom veneer patterns contact customer service at **844-815-2217** for quotation.

Long grain is standard on all WCI tables.

Single piece tables are available in lengths longer than 10' and are subject to material length availability.

Note: Material length restrictions may require WCI to manufacture the tables in two or more sections.

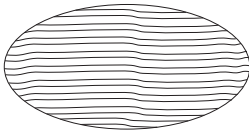

Long grain is standard on all WCI oval table tops

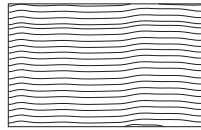

Long grain is standard on all WCI rectangle tables.

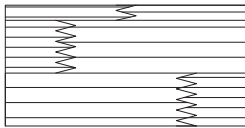

Finger jointed strips are standard on all WCI butcher block table requests.

WCI Standard Veneer Specification

Oak: White Oak, Rift cut, Slip match

Walnut: Walnut, Plain sliced, Book match

Cherry: Cherry, Plain sliced, Book match

Maple: Maple, Plain sliced, Book match

Ash: White ash, Quarter sawn, Slip match

Stain-to-Match

Send all stain-to-match samples marked with WCI's quote number. If you do not have a quote number please mark with project name and send to:

West Coast Industries
Attn: Order Entry
2779 East El Presidio ST.
Carson, CA 90810

The stain-to-match process takes 10 days.

PRODUCT SPECIFICATIONS – Grommet Locations

Specify the desired grommet location using the chart below.
For custom locations please submit a sketch for location feasibility and verification.

Grommet Locations For Radius Tops.

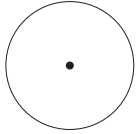

Location "A"

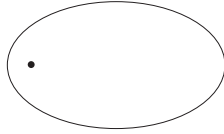

Location "B"

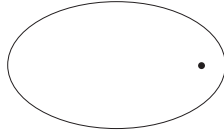

Location "C"

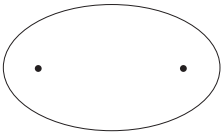

Location "D"

Grommet Locations For Square Corner Tops.

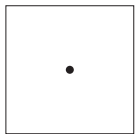

Location "A"



Location "B"



Location "C"



Location "D"

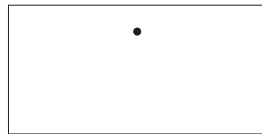

Location "E"

PRODUCT SPECIFICATIONS – ADA Tables

Wheelchair Access

To comply with ADA regulations for wheelchair access to tables WCI recommends a minimum clearance of 27" from the floor to the bottom of the table; a minimum 30" barrier free width and a minimum barrier free depth of 19". In addition there must be a minimum of 30" unobstructed space from the table edge. Overall table height cannot exceed 34".

For more information on ADA requirements, the following websites may be useful:

National Network of ADA Centers: www.adata.org

U.S. Justice Department - ADA Home Page: www.ada.gov

ABA and ABA Guidelines Home Page: www.access-board.gov

Minimum Clearance Recommendations

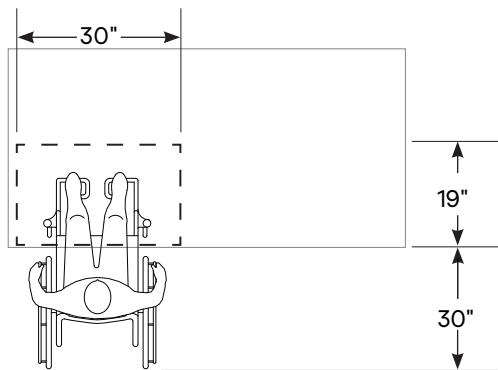

WCI ADA Table Recommendations

42" x 42" Post leg square table (PO4242SQ)

23" x 39" Bistro ADA rectangle table (BI2339REOD)

30" x 48" T- base rectangle table (DUT3048RE, ALT3048RE, MAT3048RE, PRT3048RE, SLT3048RE, SVT3048RE, TUT3048RE)

ADA Logo

The ADA logo is standard on the Bistro Outdoor rectangle table. The blue ADA symbol is 1.75" high x 5" wide and is inset from the front table edge on the right-hand side (from seated position).

Drawing is not to scale.

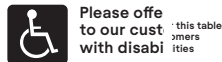
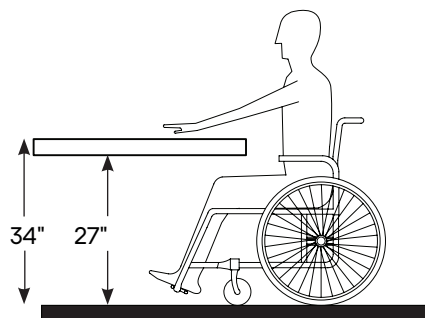

PRODUCT SPECIFICATIONS – Seating



INSIDE BACK STYLES

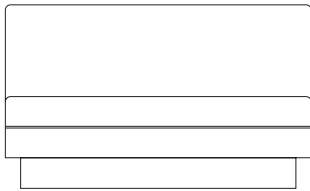

Plain upholstered (standard)

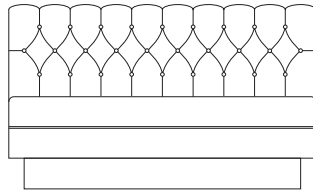

Diamond tufted

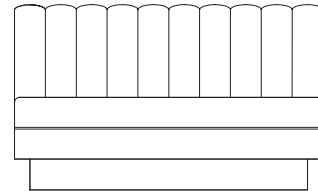

3" – 6" wide vertical channels

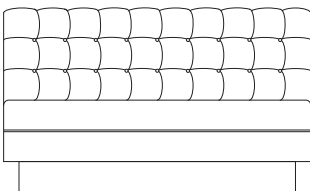

Biscuit tufted

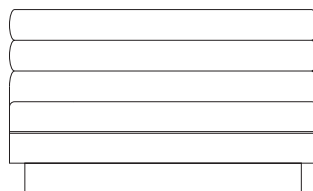

6" wide horizontal channels

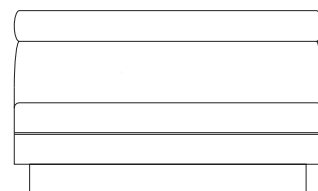

Plain back with 4" – 6" wide headroll

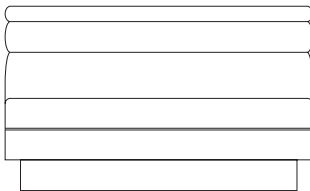

Graduating width horizontal channels

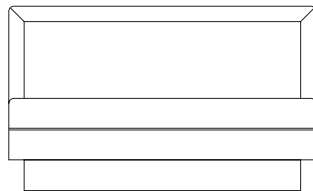

Plain back with 3" wide picture frame headroll

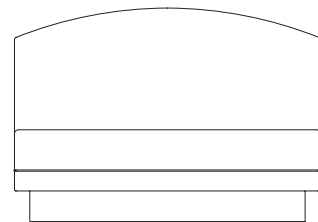

High rise curved back

PRODUCT SPECIFICATIONS – Seating



END PANEL STYLES

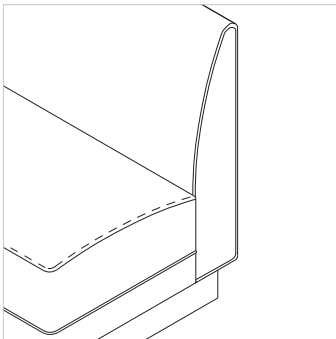

Wrap-around upholstered (standard)

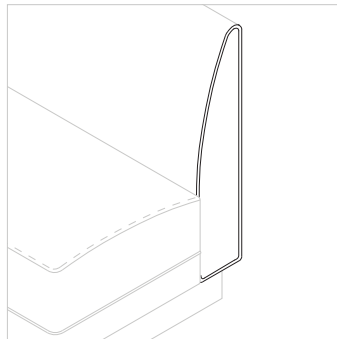

Self upholstered with welt all around

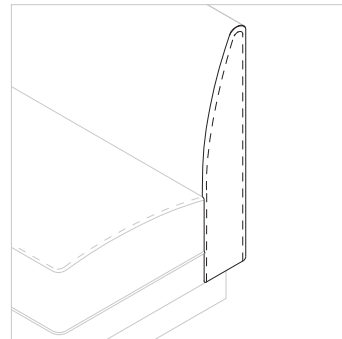

Self upholstered with french stitch

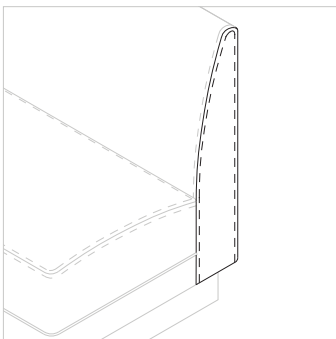

Self upholstered with baseball stitch

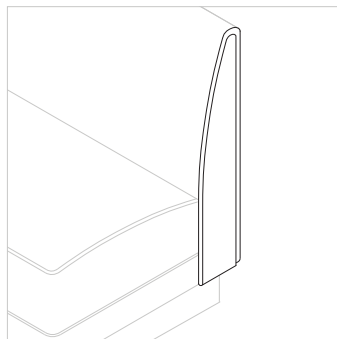

Applied upholstered end panel with welt all around

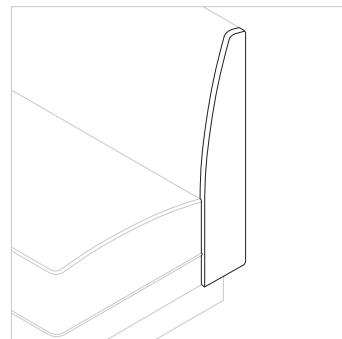

Applied laminate or wood veneer end panel

PRODUCT SPECIFICATIONS – Seating



SEAT STYLES

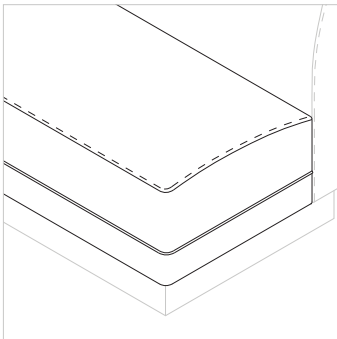

Plain upholstered with french stitch on all seat top edges (standard)

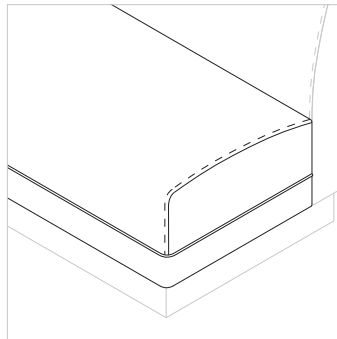

Waterfall upholstered front and back edges with french stitch on ends

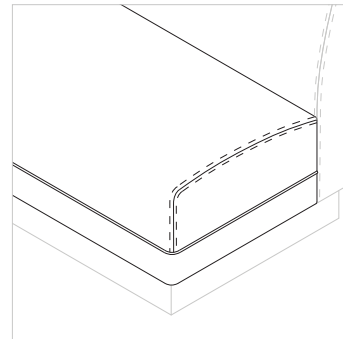

Waterfall upholstered front and back edges with baseball stitch on ends

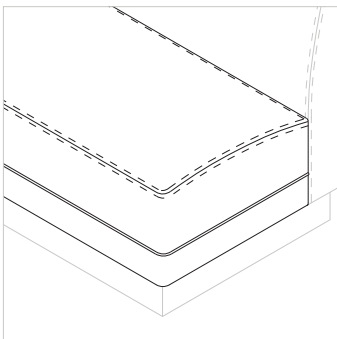

Plain upholstered with baseball stitch on all seat top edges

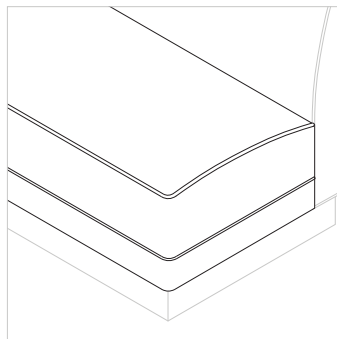

Plain upholstered with welt on all seat top edges

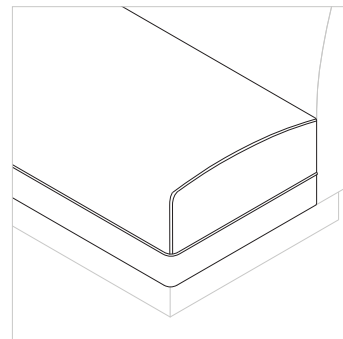

Waterfall upholstered front and back edges with welt on ends

PRODUCT SPECIFICATIONS – Seating



SEAT APRON STYLES

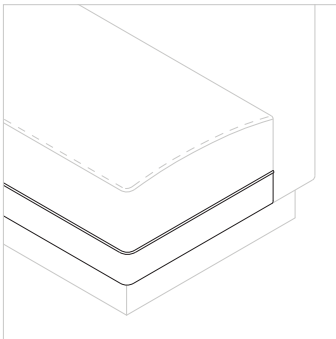

Flush seat upholstered apron with welt (standard)

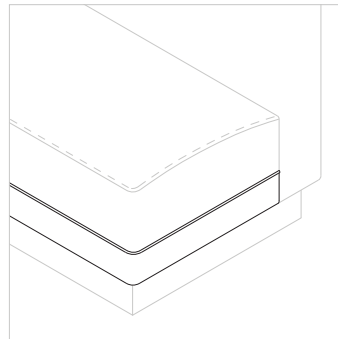

Flush seat laminate apron with welt

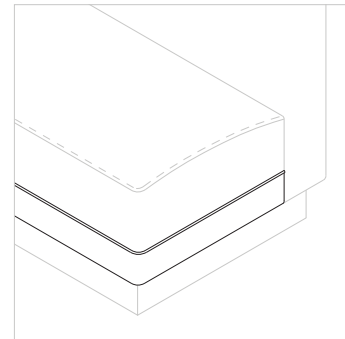

Flush seat wood veneer apron with welt

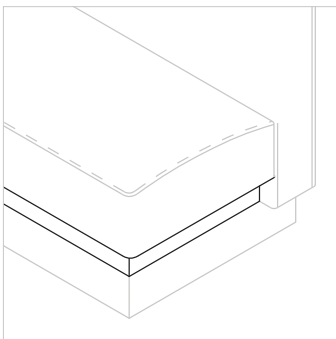

Recessed seat apron

PRODUCT SPECIFICATIONS – Seating



BASE AND LEG STYLES

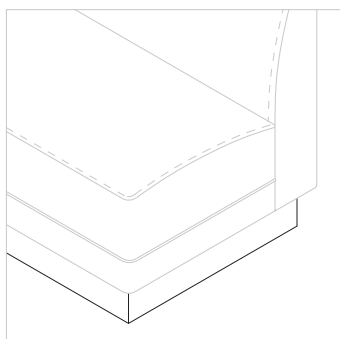

Enclosed base square corners,
square or slanted profile (standard)

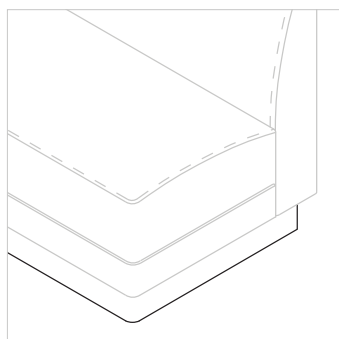

Enclosed base radius corners

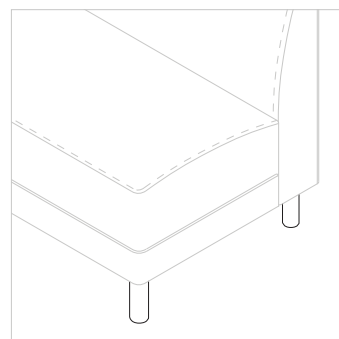

Metal or wooden round legs

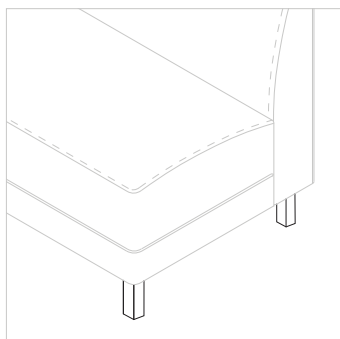

Metal or wooden square legs

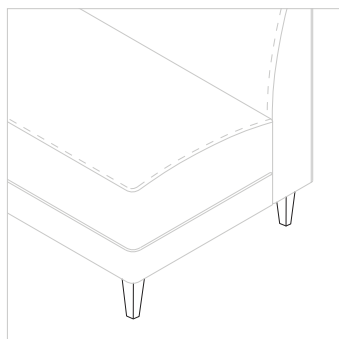

Metal or wooden tapered legs

A recessed base can be used in conjunction with leg supports for additional stability.

PRODUCT SPECIFICATIONS – Seating

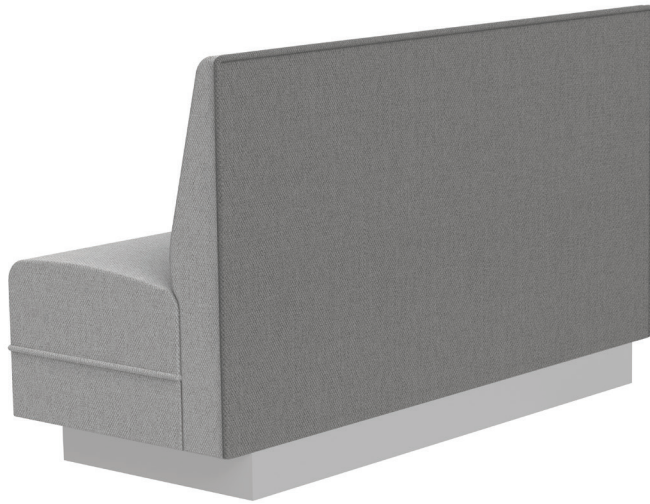

OUTSIDE BACK STYLES

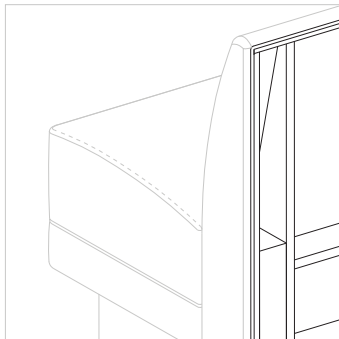

Unfinished (standard)

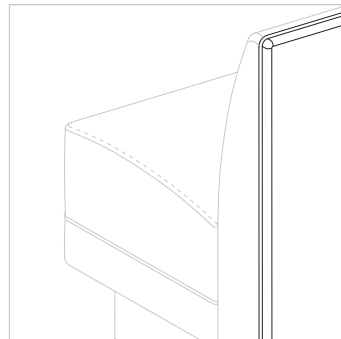

Plain upholstered with welt

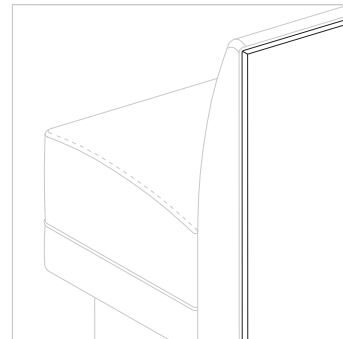

Applied laminate or wood veneer back with welt

Custom back materials are available upon request.

PRODUCT SPECIFICATIONS – Seating

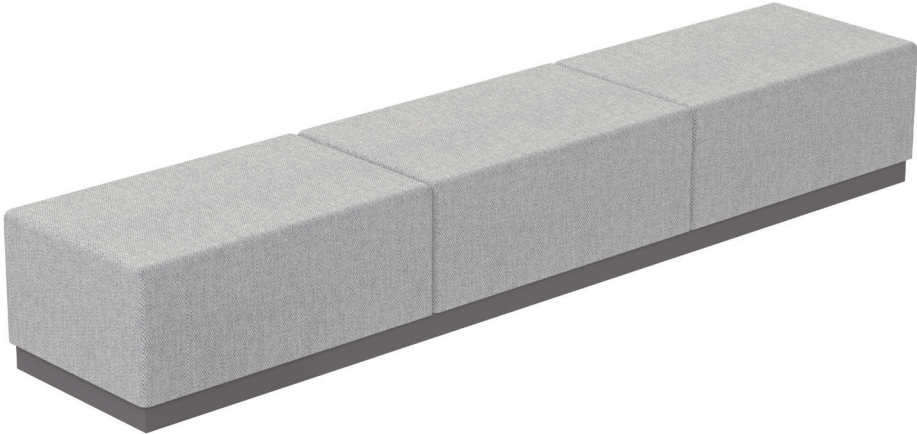

BENCH BASE AND LEG STYLES

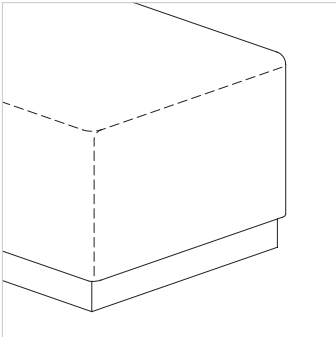

Enclosed base square corners, square or slanted profile (standard)

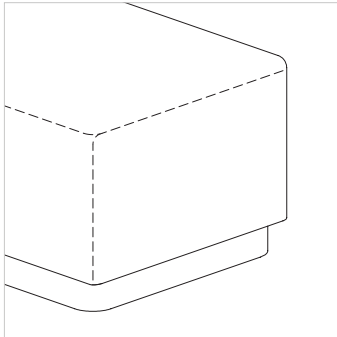

Enclosed base radius corners

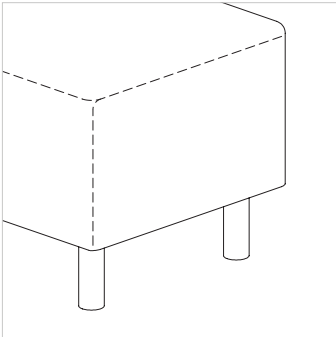

Metal or wooden round legs

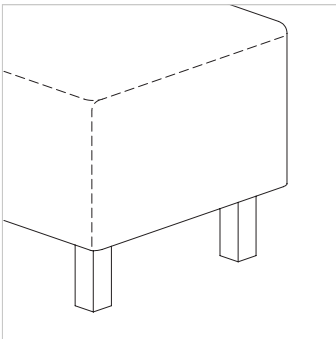

Metal or wooden square legs

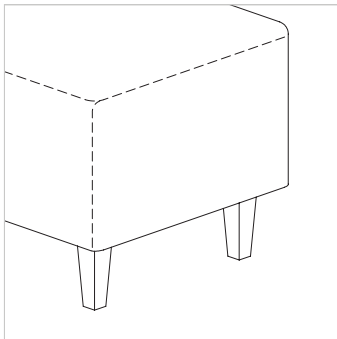

Tapered metal or wooden legs

Custom back materials are available upon request.

PRODUCT SPECIFICATIONS – Seating



OTTOMAN BASE AND LEG STYLES

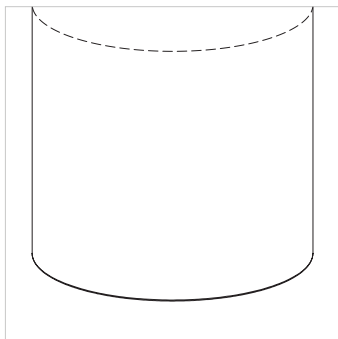

No base

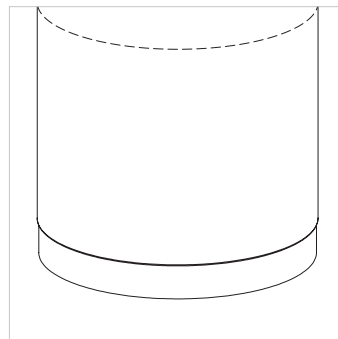

Enclosed base radius corners

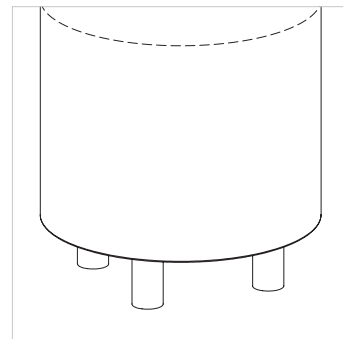

Metal or wooden round legs

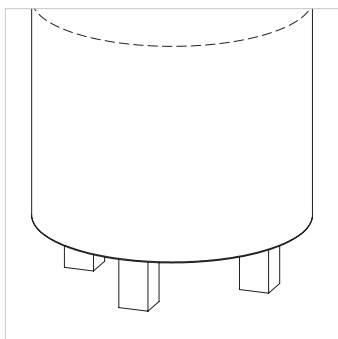

Metal or wooden square legs

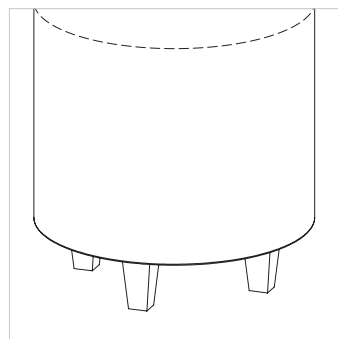

Tapered metal or wooden legs

Pricing

Dining and Multipurpose

50	Basic Round
54	Blok
56	Bolt Down
60	Brae
64	Brae Double
66	Canvas
64	Disc
76	Dunhill
82	Flat Round
86	Kone
90	Move
92	Parsons
96	Platform
100	Platform Double
102	Plus
108	Post Leg
112	Regency
116	Tulip
120	Vista

Occasional

126	Blok
128	Brae
130	Cube
132	Cylinder
134	Disc
136	Kone
138	Move
140	Parsons
144	Platform
146	Triad

Pricing

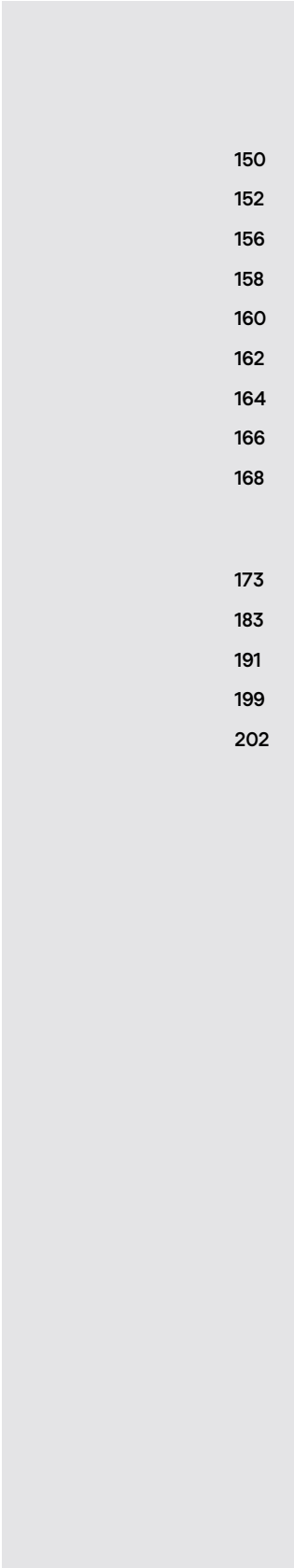

Outdoor Tables

- 150 Basic Round
- 152 Brae
- 156 Brae Double
- 158 Disc
- 160 Flat Round
- 162 Platform
- 164 Platform Double
- 166 Tulip
- 168 Vista

- 173 Base and Top Matrix
- 183 Base Only Pricing
- 191 Top Only Pricing
- 199 Options Pricing
- 202 Power & Data

BASIC ROUND – Dining

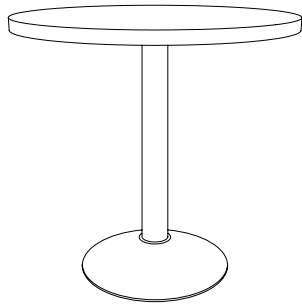

Laminate Surface

Wood Surface

Self Edge	Vinyl Edges	PVC Edges	Wood Edges Group A	Wood Edges Group B	Wood Edges Group A	Wood Edges Group B	Butcher Block
LLSE Self Edge	LVFL Flat	LPVC PVC	LWFL Flat	LWSQ Square	WWFL Flat	WWSQ Square	BBFL Flat
	LVBP Bumper		LWTP Tapered Ply	LWBN Bullnose	WWTP Tapered Ply	WWBN Bullnose	BBBN Bullnose
			LWFP Flat Ply	LWPR Prism	WWFP Flat Ply	WWPR Prism	

Complete Table List Pricing

	Top Size	Base Qty.	Base Style	Model #								
Round	24	1	17L	BA24RD	558	558	638	891	1,158	905	1,274	1,140
	30	1	17M	BA30RD	711	711	809	1,126	1,414	1,236	1,552	1,587
	36	1	20M	BA36RD	889	889	1,004	1,379	1,712	1,419	1,879	2,127
	42	1	22L	BA42RD	1,041	1,041	1,170	1,553	1,965	1,703	2,165	2,955
	48	1	22M	BA48RD	1,268	1,268	1,414	1,838	2,310	2,015	2,547	3,456
	54	1	22H	BA54RD	1,508	1,508	1,675	2,244	3,219	2,464	3,559	-
	60	1	28H	BA60RD	2,019	2,019	2,199	2,664	3,578	3,237	3,938	-
RD Square	24 24	1	17L	BA2424RS	560	560	648	890	1,159	905	1,274	1,251
	30 30	1	17M	BA3030RS	711	711	818	1,125	1,414	1,236	1,552	1,735
	36 36	1	20M	BA3636RS	890	890	998	1,362	1,712	1,420	1,879	2,316
	42 42	1	22M	BA4242RS	1,085	1,085	1,207	1,617	2,028	1,766	2,228	3,312
	48 48	1	22H	BA4848RS	1,333	1,333	1,475	1,900	2,372	2,077	2,608	3,862
Square	24 24	1	17L	BA2424SQ	560	560	648	890	1,159	905	1,274	1,251
	30 30	1	17M	BA3030SQ	711	711	818	1,125	1,414	1,236	1,552	1,735
	36 36	1	20M	BA3636SQ	890	890	998	1,362	1,712	1,420	1,879	2,316
	42 42	1	22M	BA4242SQ	1,085	1,085	1,207	1,617	2,028	1,766	2,228	3,312
	48 48	1	22H	BA4848SQ	1,333	1,333	1,475	1,900	2,372	2,077	2,608	3,862

Continued on next page

How to Order

Table Model Number

BA Base Series	36 Top Size	RD Top Shape	WWSQ Top Material Edge Profile	WMW Top Finish	N/A Edge Finish	MBM Base Finish
--------------------------	-----------------------	------------------------	---	--------------------------	---------------------------	---------------------------







Options

GSL Super Level Glides

A BA36RDWWSQWMWMBM is a Basic Round series 36" round table with a black powder coated, round base and a wood veneer 1.25" thick top with a 1.25" square wood edge profile.

Edge finish applies when edge material is different from top material.

The code: GSL specifies super level glides.

Solid Surface	Quartz Surface	
Corian®	Caesarstone® Q1	Okite® Q2
		
COFL Flat	Q1FL Flat	Q2FL Flat
		
COBN Bullnose	Q1BN Bullnose	Q2BN Bullnose
		
COPR Prism		

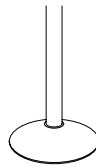

Options

Base Finishes

Standard Black Texture	MBT	n/c
Powder Coat (per base)	use finish code	127
Custom Powder Coat (set-up charge)	CPC	📞
Polished or Satin Chrome (per base)	use finish code	275
Premium Plated (per base)	use finish code	550

Base Options

Counter, Bar, & Alternate Height (per column)	CH, BH, AH	76
Super Level Glides (per base)	GSL	40
Custom Top Plate Size	CTPS	📞
6" Column (black texture and powder coat)	COL6	224
6" Column (polished or satin chrome)	COLP6	286
6" Column (premium plated)	COLPP6	📞
6" Column (veneer)	COLV6	446
Base sizes may vary with quartz tops		

Top Materials and Finishes

Any non-standard WCI Laminates (set-up charge)	use manufacturers finish code	165
Premium Laminates	PL	📞
Custom Wood Veneer	CWV	📞
Stain to Match (set-up charge)	STM	476

Top Options

3" Radius Corner (per corner) (laminate self edge, Ultrafoam, Corian®, 3form® Chroma®)	CRL3	40
3" Wood Radius Corner (per corner) (not available in LWFL and WWFL)	CRW3	95
Custom Size	CS	📞
Custom Radius Corner	CRC	95
Custom Shape	CSH	📞
Custom Edge Thickness	CET	📞

1,394	3,321	4,646
1,883	4,343	6,690
2,488	6,029	8,069
3,103	7,382	10,272
3,872	-	-
4,706	-	-
5,812	-	-
-	-	-
-	-	-
-	-	-
-	-	-
-	-	-
1,260	2,131	3,975
1,715	3,566	5,799
2,301	4,596	7,267
2,941	6,311	9,089
3,689	-	-

📞 Call for pricing

844.815.2217

BASIC ROUND – Dining

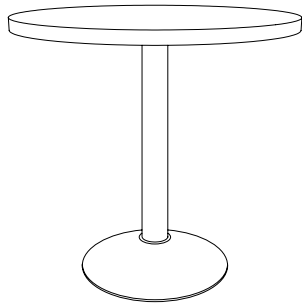

Laminate Surface

Wood Surface

Self Edge	Vinyl Edges	PVC Edges	Wood Edges Group A	Wood Edges Group B	Wood Edges Group A	Wood Edges Group B	Butcher Block
LLSE Self Edge	LVFL Flat	LPVC PVC	LWFL Flat	LWSQ Square	WWFL Flat	WWSQ Square	BBFL Flat
	LVBP Bumper		LWTP Tapered Ply	LWBN Bullnose	WWTP Tapered Ply	WWBN Bullnose	BBBN Bullnose
			LWFP Flat Ply	LWPR Prism	WWFP Flat Ply	WWPR Prism	

Complete Table List Pricing

	Top Size	Base Qty.	Base Style	Model #									
Rectangle	24	30	1	17M	BA2430RE	661	661	736	1,044	1,340	1,170	1,467	1,493
	24	36	1	20M	BA2436RE	758	758	842	1,195	1,482	1,299	1,624	1,758
	24	42	1	22L	BA2442RE	802	802	873	1,251	1,570	1,363	1,719	2,057
	24	48	1	22M	BA2448RE	922	922	1,011	1,429	1,783	1,557	1,950	2,208
	24	60	2	17L	BA2460RE	1,115	1,115	1,212	1,660	2,061	1,800	2,253	2,703
	24	72	2	17L	BA2472RE	1,208	1,208	1,319	1,814	2,275	1,977	2,496	3,101
	30	36	1	20M	BA3036RE	831	831	901	1,279	1,594	1,394	1,747	2,031
	30	42	1	22L	BA3042RE	878	878	960	1,421	1,775	1,552	1,950	2,411
	30	48	1	22M	BA3048RE	1,000	1,000	1,089	1,557	1,940	1,701	2,130	2,570
	30	60	2	17M	BA3060RE	1,334	1,334	1,437	1,940	2,380	2,105	2,597	3,252
	30	72	2	17M	BA3072RE	1,443	1,443	1,566	2,061	2,560	2,243	2,798	3,736
	36	42	1	22M	BA3642RE	1,016	1,016	1,110	1,573	1,962	1,720	2,153	2,815
	36	48	1	22M	BA3648RE	1,081	1,081	1,179	1,659	2,075	1,813	2,277	2,919
	36	60	2	20M	BA3660RE	1,544	1,544	1,659	2,136	2,608	2,313	2,844	3,782
	36	72	2	20M	BA3672RE	1,675	1,675	1,799	2,341	2,873	2,540	3,143	4,342

How to Order

Table Model Number

BA Base Series	36 Top Size	RD Top Shape	WWSQ Top Material Edge Profile	WMW Top Finish	N/A Edge Finish	MBM Base Finish
--------------------------	-----------------------	------------------------	---	--------------------------	---------------------------	---------------------------







Options

GSL Super Level Glides

A BA36RDWWSQWMWMBM is a Basic Round series 36" round table with a black powder coated, round base and a wood veneer 1.25" thick top with a 1.25" square wood edge profile.

Edge finish applies when edge material is different from top material.

The code: GSL specifies super level glides.

Solid Surface	Quartz Surface	
Corian®	Caesarstone® Q1	Okite® Q2
		
COFL Flat	Q1FL Flat	Q2FL Flat
		
COBN Bullnose	Q1BN Bullnose	Q2BN Bullnose
		
COPR Prism		

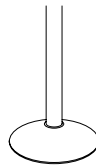

Options

Base Finishes

Standard Black Texture	MBT	n/c
Powder Coat (per base)	use finish code	127
Custom Powder Coat (set-up charge)	CPC	📞
Polished or Satin Chrome (per base)	use finish code	275
Premium Plated (per base)	use finish code	550

Base Options

Counter, Bar, & Alternate Height (per column)	CH, BH, AH	76
Super Level Glides (per base)	GSL	40
Custom Top Plate Size	CTPS	📞
6" Column (black texture and powder coat)	COL6	224
6" Column (polished or satin chrome)	COLP6	286
6" Column (premium plated)	COLPP6	📞
6" Column (veneer)	COLV6	446
Base sizes may vary with quartz tops		

Top Materials and Finishes

Any non-standard WCI Laminates (set-up charge)	use manufacturers finish code	165
Premium Laminates	PL	📞
Custom Wood Veneer	CWV	📞
Stain to Match (set-up charge)	STM	476

Top Options

3" Radius Corner (per corner) (laminate self edge, Ultrafoam, Corian®, 3form® Chroma®)	CRL3	40
3" Wood Radius Corner (per corner) (not available in LWFL and WWFL)	CRW3	95
Custom Size	CS	📞
Custom Radius Corner	CRC	95
Custom Shape	CSH	📞
Custom Edge Thickness	CET	📞









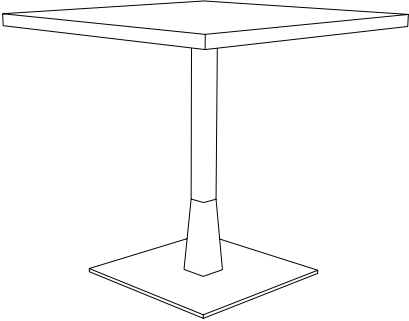







1,499	2,167	4,562
1,731	2,484	5,145
1,900	2,846	5,488
2,143	-	-
2,630	-	-
3,010	-	-
1,991	3,158	6,028
2,201	3,395	6,196
2,507	-	-
3,169	-	-
3,626	-	-
2,870	4,149	7,427
3,391	-	-
3,738	-	-
4,259	-	-

📞 Call for pricing



844.815.2217

BLOK – Dining & Multipurpose



Laminate Surface			Wood Surface		
Self Edge	PVC Edges	Wood Edges Group A	Wood Edges Group A	Wood Edges Group B	Butcher Block
 LLSE Self Edge	 LPVC PVC	 LWFL Flat	 WWFL Flat	 WWSQ Square	 BBFL Flat
 LFSE Facet Self Edge		 LWTP Tapered Ply	 WWTP Tapered Ply	 WWBN Bullnose	 BBBN Bullnose
		 LWFP Flat Ply	 WWFP Flat Ply	 WWPR Prism	
			 WWFC Facet	 WWFC Facet	







Complete Table List Pricing

	Top Size		Base Qty.	Model #						
Round 	24	24	1	BL24RD	1,612	1,691	1,942	1,958	2,324	2,191
	30	30	1	BL30RD	1,708	1,804	2,121	2,231	2,547	2,582
	36	36	1	BL36RD	2,053	2,167	2,540	2,581	3,038	3,287
	48	48	1	BL48RD	2,910	3,054	3,477	3,654	4,183	5,090
Square 	24	24	1	BL2424SQ	1,613	1,701	1,942	1,958	2,324	2,302
	30	30	1	BL3030SQ	1,708	1,815	2,121	2,231	2,547	2,728
	36	36	1	BL3636SQ	2,053	2,159	2,522	2,581	3,038	3,473
	42	42	1	BL4242SQ	2,726	2,847	3,256	3,406	3,865	4,946
	48	48	1	BL4848SQ	2,912	3,054	3,477	3,654	4,183	5,433
Rectangle 	24	30	1	BL2430RE	1,658	1,734	2,039	2,166	2,462	2,487
	24	42	1	BL2442RE	1,756	1,828	2,203	2,316	2,671	3,007
	24	48	2	BL2448RE	3,124	3,213	3,630	3,757	4,150	4,407
	24	60	2	BL2460RE	3,222	3,318	3,763	3,903	4,356	4,804
	30	36	1	BL3036RE	1,993	2,064	2,441	2,555	2,906	3,189
	30	42	1	BL3042RE	2,050	2,132	2,592	2,721	3,120	3,578
	30	48	1	BL3048RE	2,641	2,730	3,196	3,340	3,768	4,205
	30	60	2	BL3060RE	3,329	3,431	3,934	4,098	4,587	5,240
	30	72	2	BL3072RE	3,438	3,560	4,054	4,235	4,787	5,723
	36	42	1	BL3642RE	2,124	2,218	2,680	2,826	3,258	3,916
	36	48	1	BL3648RE	2,724	2,820	3,298	3,452	3,915	4,554
	36	60	2	BL3660RE	3,434	3,550	4,025	4,202	4,730	5,665
	36	72	2	BL3672RE	3,565	3,688	4,230	4,428	5,028	6,223

How to Order

Table Model Number							Options	
BL Base Series	36 36 Top Size	SQ Top Shape	WWFC Top Material Edge Profile	WMW Top Finish	N/A Edge Finish	MBM Base Finish	WMW Wood Column Finish	AH Alternate Height Base
A BL3636SQWWFCWMWMBMWMW is a Blok series 36" x 36" square table with a black powder coat square base and a wood veneer 1.25" thick top with a 1.25" wood edge profile.					Edge finish applies when edge material is different from top material.			The code: AH specifies alternate height base.

Solid Surface Quartz

Corian®	Caesarstone® Q1	Okite® Q2
		
COFL Flat	Q1FL Flat	Q2FL Flat
		
COBN Bullnose	Q1BN Bullnose	Q2BN Bullnose
		
COPR Prism		

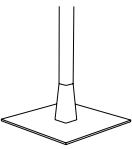

2,444	4,365	5,687
2,878	5,328	7,669
3,645	7,175	9,209
5,506	-	-
2,310	3,180	5,018
2,708	4,555	6,780
3,460	5,748	8,410
4,578	7,935	10,705
5,260	-	-
2,495	3,160	5,546
2,850	3,794	6,428
4,342	-	-
4,731	-	-
3,149	4,314	7,175
3,368	4,558	7,352
4,144	-	-
5,159	-	-
5,612	-	-
3,972	5,247	8,515
5,025	-	-
5,622	-	-
6,140	-	-

Options

Base Finishes		
Custom Powder Coat (set-up charge)	CPC	📞
Polished or Satin Chrome (per base)	use finish code	660
Premium Plated (per base)	use finish code	1,430
Stainless Steel (per base)	use finish code	1,650

Base Options		
Alternate Height Base (per column)(29.25 or lower)	AH	76
Nylon Octagon Glides (per base)	GNO	40
Custom Top Plate Size	CTPS	📞
Base sizes may vary with quartz tops		

Top Materials and Finishes		
Any non-standard WCI Laminates (set-up charge)	use manufacturers finish code	165
Premium Laminates	PL	📞
Custom Wood Veneer	CWV	📞
Stain to Match (set-up charge)	STM	476

Top Options		
3" Radius Corner (per corner) (laminate self edge, Ultrafoam, Corian®, 3form® Chroma®)	CRL3	40
3" Wood Radius Corner (per corner) (not available in LWFL and WWFL)	CRW3	95
Custom Radius Corner	CRC	95
Custom Size	CS	📞
Custom Shape	CSH	📞
Custom Edge Thickness	CET	📞



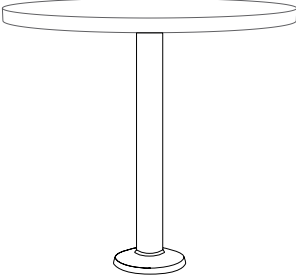

📞 Call for pricing 844.815.2217

BOLT DOWN – Dining



Laminate Surface					Wood Surface				
Self Edge	Vinyl Edges	PVC Edges	Wood Edges Group A	Wood Edges Group B	Wood Edges Group A	Wood Edges Group B	Butcher Block		
LLSE Self Edge	LVFL Flat	LPVC PVC	LWFL Flat	LWSQ Square	WWFL Flat	WWSQ Square	BBFL Flat		
	LVBP Bumper		LWTP Tapered Ply	LWBN Bullnose	WWTP Tapered Ply	WWBN Bullnose	BBBN Bullnose		
			LWFP Flat Ply	LWPR Prism	WWFP Flat Ply	WWPR Prism			

Complete Table List Pricing

	Top Size	Base Qty.	Model #								
 Round	24	1	JB24RD	692	692	772	1,025	1,293	1,040	1,408	1,274
	30	1	JB30RD	790	790	887	1,205	1,492	1,315	1,630	1,667
	36	1	JB36RD	916	916	1,031	1,406	1,738	1,445	1,905	2,154
	42	1	JB42RD	1,077	1,077	1,206	1,588	2,000	1,738	2,200	2,991
	48	1	JB48RD	1,241	1,241	1,385	1,811	2,283	1,988	2,519	3,429
 RD Square	24 24	1	JB2424RS	694	694	782	1,024	1,294	1,040	1,408	1,385
	30 30	1	JB3030RS	789	789	897	1,205	1,492	1,315	1,630	1,813
	36 36	1	JB3636RS	916	916	1,024	1,388	1,738	1,447	1,905	2,342
	42 42	1	JB4242RS	1,057	1,057	1,178	1,590	2,000	1,738	2,200	3,284
	48 48	1	JB4848RS	1,244	1,244	1,385	1,811	2,283	1,988	2,519	3,773
 Square	24 24	1	JB2424SQ	694	694	782	1,024	1,294	1,040	1,408	1,385
	30 30	1	JB3030SQ	789	789	897	1,205	1,492	1,315	1,630	1,813
	36 36	1	JB3636SQ	916	916	1,024	1,388	1,738	1,447	1,905	2,342
	42 42	1	JB4242SQ	1,057	1,057	1,178	1,590	2,000	1,738	2,200	3,284
	48 48	1	JB4848SQ	1,244	1,244	1,385	1,811	2,283	1,988	2,519	3,773
 Rectangle	24 30	1	JB2430RE	739	739	814	1,122	1,418	1,250	1,546	1,571
	24 36	1	JB2436RE	784	784	868	1,221	1,508	1,326	1,650	1,785
	24 42	1	JB2442RE	837	837	910	1,286	1,605	1,398	1,756	2,092
	24 48	1	JB2448RE	893	893	983	1,401	1,756	1,528	1,923	2,180
	24 60	2	JB2460RE	1,384	1,384	1,480	1,927	2,330	2,068	2,521	2,970
	24 72	2	JB2472RE	1,476	1,476	1,587	2,082	2,542	2,245	2,763	3,368

Continued on next page

How to Order

Table Model Number						Options	
JB Base Series	36 Top Size	RD Top Shape	WWSQ Top Material Edge Profile	WMW Top Finish	N/A Edge Finish	MBM Base Finish	AH Alternate Height Base
A JB36RDWWSQWMWMBM is a Bolt Down series 36" round table with a black powder coat bolt down base and a wood veneer 1.25" thick top with a 1.25" square wood edge profile.						Edge finish applies when edge material is different from top material.	
						The code: AH specifies alternate height base.	

Solid Surface

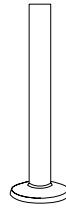
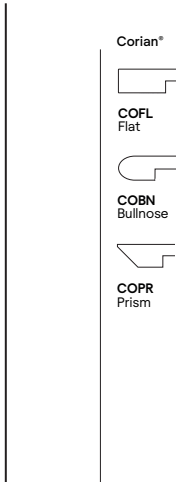

1,528
1,962
2,515
3,138
3,845
-
-
-
-
-
1,394
1,793
2,328
2,914
3,600
1,579
1,758
1,935
2,115
2,899
3,278

Options

Base Finishes		
Custom Powder Coat (set-up charge)	CPC	☎
Polished or Satin Chrome (per base)	use finish code	88
Premium Plated (per base)	use finish code	138
Stainless Steel (per base)	use finish code	1,650
Base Options		
Counter, Bar, & Alternate Height (per column)	CH, BH, AH	76
Custom Top Plate Size	CTPS	☎
Top Materials and Finishes		
Any non-standard WCI Laminates (set-up charge)	use manufacturers finish code	165
Premium Laminates	PL	☎
Custom Wood Veneer	CWV	☎
Stain to Match (set-up charge)	STM	476
Top Options		
3" Radius Corner (per corner) (laminare self edge, Ultrafoam, Corian®, 3form® Chroma®)	CRL3	40
3" Wood Radius Corner (per corner) (not available in LWFL and WWFL)	CRW3	95
Custom Radius Corner	CRC	95
Custom Size	CS	☎
Custom Shape	CSH	☎
Custom Edge Thickness	CET	☎

☎ Call for pricing

844.815.2217

BOLT DOWN – Dining

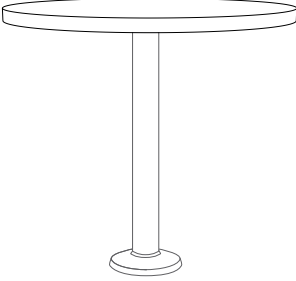

Laminate Surface				Wood Surface			
Self Edge	Vinyl Edges	PVC Edges	Wood Edges Group A	Wood Edges Group B	Wood Edges Group A	Wood Edges Group B	Butcher Block
LLSE Self Edge	LVFL Flat	LPVC PVC	LWFL Flat	LWSQ Square	WWFL Flat	WWSQ Square	BBFL Flat
	LVBP Bumper		LWTP Tapered Ply	LWBN Bullnose	WWTP Tapered Ply	WWBN Bullnose	BBBN Bullnose
			LWFP Flat Ply	LWPR Prism	WWFP Flat Ply	WWPR Prism	

Complete Table List Pricing

	Top Size		Base Qty.	Model #								
Rectangle	30	36	1	JB3036RE	857	857	927	1,306	1,620	1,421	1,773	2,057
	30	42	1	JB3042RE	913	913	996	1,456	1,811	1,588	1,987	2,446
	30	48	1	JB3048RE	971	971	1,060	1,528	1,913	1,673	2,102	2,541
	30	60	2	JB3060RE	1,492	1,492	1,593	2,098	2,537	2,262	2,753	3,408
	30	72	2	JB3072RE	1,601	1,601	1,724	2,218	2,717	2,399	2,955	3,893
	36	42	1	JB3642RE	989	989	1,082	1,546	1,935	1,693	2,125	2,786
	36	48	1	JB3648RE	1,054	1,054	1,152	1,630	2,047	1,785	2,250	2,892
	36	60	2	JB3660RE	1,597	1,597	1,713	2,190	2,662	2,367	2,896	3,835
	36	72	2	JB3672RE	1,728	1,728	1,851	2,394	2,926	2,594	3,196	4,395

How to Order

Table Model Number							Options
JB Base Series	36 Top Size	RD Top Shape	WWSQ Top Material Edge Profile	WMW Top Finish	N/A Edge Finish	MBM Base Finish	AH Alternate Height Base
<p>A JB36RDWWSQWMWMBM is a Bolt Down series 36" round table with a black powder coat bolt down base and a wood veneer 1.25" thick top with a 1.25" square wood edge profile.</p>						<p>Edge finish applies when edge material is different from top material.</p>	<p>The code: AH specifies alternate height base.</p>

Solid Surface

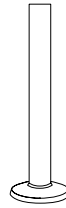
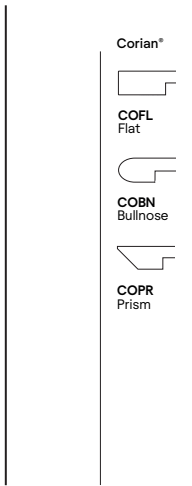

2,017
2,236
2,479
3,326
3,782
2,841
3,363
3,791
4,312

Options

Base Finishes

Custom Powder Coat (set-up charge)	CPC	Call for pricing
Polished or Satin Chrome (per base)	use finish code	88
Premium Plated (per base)	use finish code	138
Stainless Steel (per base)	use finish code	1,650

Base Options

Counter, Bar, & Alternate Height (per column)	CH, BH, AH	76
Custom Top Plate Size	CTPS	Call for pricing

Top Materials and Finishes

Any non-standard WCI Laminates (set-up charge)	use manufacturers finish code	165
Premium Laminates	PL	Call for pricing
Custom Wood Veneer	CWV	Call for pricing
Stain to Match (set-up charge)	STM	476

Top Options

3" Radius Corner (per corner) (laminare self edge, Ultrafoam, Corian®, 3form® Chroma®)	CRL3	40
3" Wood Radius Corner (per corner) (not available in LWFL and WWFL)	CRW3	95
Custom Radius Corner	CRC	95
Custom Size	CS	Call for pricing
Custom Shape	CSH	Call for pricing
Custom Edge Thickness	CET	Call for pricing

Call for pricing



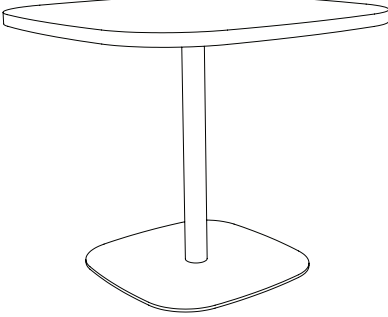

844.815.2217

BRAE – Dining & Multipurpose



Laminate Surface						Wood Surface					
Self Edge	Vinyl Edges	PVC Edges	Wood Edges Group A	Wood Edges Group B	Wood Edges Group A	Wood Edges Group B	Butcher Block				
LLSE Self Edge	LVFL Flat	LPVC PVC	LWFL Flat	LWSQ Square	WWFL Flat	WWSQ Square	BBFL Flat				
	LVBP Bumper		LWTP Tapered Ply	LWBN Bullnose	WWTP Tapered Ply	WWBN Bullnose	BBBN Bullnose				
			LWFP Flat Ply	LWPR Prism	WWFP Flat Ply	WWPR Prism					







Complete Table List Pricing

	Top Size	Base Qty.	Model #								
Round 	24	1	BR24RD	1,076	1,076	1,155	1,408	1,676	1,423	1,791	1,658
	30	1	BR30RD	1,173	1,173	1,271	1,587	1,874	1,697	2,014	2,049
	36	1	BR36RD	1,585	1,585	1,701	2,075	2,407	2,115	2,574	2,824
	42	1	BR42RD	1,746	1,746	1,874	2,258	2,670	2,407	2,869	3,660
	48	1	BR48RD	2,133	2,133	2,277	2,702	3,174	2,879	3,410	4,320
	54	1	BR54RD	2,310	2,310	2,477	3,046	4,021	3,266	4,360	-
	60	1	BR60RD	2,591	2,591	2,771	3,236	4,150	3,809	4,510	-
RD Square 	24 24	1	BR2424RS	1,078	1,078	1,165	1,408	1,676	1,423	1,791	1,769
	30 30	1	BR3030RS	1,173	1,173	1,280	1,587	1,874	1,697	2,014	2,196
	36 36	1	BR3636RS	1,585	1,585	1,694	2,057	2,407	2,115	2,574	3,011
	42 42	1	BR4242RS	1,726	1,726	1,848	2,258	2,670	2,407	2,869	3,953
	48 48	1	BR4848RS	2,135	2,135	2,277	2,702	3,174	2,879	3,410	4,664
Square 	24 24	1	BR2424SQ	1,078	1,078	1,165	1,408	1,676	1,423	1,791	1,769
	30 30	1	BR3030SQ	1,173	1,173	1,280	1,587	1,874	1,697	2,014	2,196
	36 36	1	BR3636SQ	1,585	1,585	1,694	2,057	2,407	2,115	2,574	3,011
	42 42	1	BR4242SQ	1,726	1,726	1,848	2,258	2,670	2,407	2,869	3,953
	48 48	1	BR4848SQ	2,135	2,135	2,277	2,702	3,174	2,879	3,410	4,664
Rectangle 	24 30	1	BR2430RE	1,122	1,122	1,198	1,506	1,802	1,634	1,929	1,955
	24 36	1	BR2436RE	1,453	1,453	1,537	1,890	2,178	1,995	2,320	2,454
	24 42	1	BR2442RE	1,507	1,507	1,579	1,956	2,275	2,067	2,423	2,761
	24 48	1	BR2448RE	1,562	1,562	1,652	2,069	2,423	2,198	2,592	2,849
	24 60	2	BR2460RE	2,151	2,151	2,246	2,695	3,097	2,835	3,288	3,737
	24 72	2	BR2472RE	2,243	2,243	2,354	2,849	3,309	3,012	3,531	4,135
	24 84	2	BR2484RE	2,588	2,588	2,692	2,979	3,758	3,159	4,034	4,428
	24 96	2	BR2496RE	2,681	2,681	2,794	3,110	3,949	3,303	4,250	4,719

Continued on next page

How to Order

Table Model Number							Options	
BR Base Series	4896 Top Size	RD Top Shape	WWSQ Top Material Edge Profile	WMW Top Finish	N/A Edge Finish	MBM Base Finish	GMBM Matte Black Grommet	E Location "E"
A BR4896RAWWSQWMWMBM is a Brae series 48" x 96" racetrack table with two black powder coat bases and a wood veneer 1.25" thick top with a 1.25" square wood edge profile.							Edge finish applies when edge material is different from top material.	
							The code: GMBM specifies a matte black 2" diameter metal grommet.	
							The code: E specifies the location of the grommet.	

Solid Surface	Quartz Surface	
Corian®	Caesarstone® Q1	Okite® Q2
		
COFL Flat	Q1FL Flat	Q2FL Flat
		
COBN Bullnose	Q1BN Bullnose	Q2BN Bullnose
		
COPR Prism		

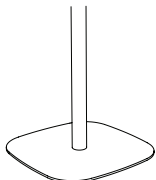

Options

Base Finishes		
Custom Powder Coat (set-up charge)	CPC	660
Polished or Satin Chrome (per base)	use finish code	1,430
Premium Plated (per base)	use finish code	1,650
Stainless Steel (per base)	use finish code	1,650

Base Options		
Counter, Bar, & Alternate Height (per column)	CH, BH, AH	76
Nylon Octagon Glides (per base)	GNO	40
Custom Top Plate Size	CTPS	660
6" Column (black texture and powder coat)	COL6	224
6" Column (polished or satin chrome)	COLP6	286
6" Column (premium plated)	COLPP6	660
6" Column (veneer)	COLV6	446
Base sizes may vary with quartz tops		

Top Materials and Finishes		
Any non-standard WCI Laminates (set-up charge)	use manufacturers finish code	165
Premium Laminates	PL	660
Custom Wood Veneer	CWV	660
Stain to Match (set-up charge)	STM	476

Top Options		
3" Radius Corner (per corner) (laminate self edge, Ultrafoam, Corian®, 3form® Chroma®)	CRL3	40
3" Wood Radius Corner (per corner) (not available in LWFL and WWFL)	CRW3	95
Custom Size	CS	660
Custom Radius Corner	CRC	95
Custom Shape	CSH	660
Custom Edge Thickness	CET	660

Grommets		
2" Round Metal Grommet - Matte Black	GMBM	160
2" Round Metal Grommet - Satin Chrome	GMSC	160
2" Round Metal Grommet - Polished Chrome	GMPC	160
2" Round Plastic Grommet - Matte Black	GPMBM	51
Grommet location	use location code	n/c

1,912	3,838	5,163
2,345	4,805	7,152
3,185	6,724	8,764
3,808	8,087	10,977
4,737	-	-
5,508	-	-
6,384	-	-
-	-	-
-	-	-
-	-	-
-	-	-
-	-	-
1,778	2,649	4,494
2,177	4,029	6,262
2,996	5,291	7,963
3,584	6,952	9,731
4,492	-	-
1,961	2,629	5,024
2,428	3,179	5,841
2,605	3,551	6,193
2,784	-	-
3,665	-	-
4,045	-	-
-	-	-
-	-	-

Call for pricing 844.815.2217

BRAE – Dining & Multipurpose

	Laminate Surface						Wood Surface					
	Self Edge	Vinyl Edges	PVC Edges	Wood Edges Group A	Wood Edges Group B	Wood Edges Group A	Wood Edges Group B	Butcher Block				
	LLSE Self Edge	LVFL Flat LVBP Bumper	LPVC PVC	LWFL Flat LWTP Tapered Ply LWFP Flat Ply	LWSQ Square LWBN Bullnose LWPR Prism	WWFL Flat WWTP Tapered Ply WWFP Flat Ply	WWSQ Square WWBN Bullnose WWPR Prism	BBFL Flat BBBN Bullnose				

Complete Table List Pricing

	Top Size	Base Qty.	Model #	1,526	1,526	1,596	1,975	2,290	2,090	2,443	2,726
	30 36	1	BR3036RE	1,526	1,526	1,596	1,975	2,290	2,090	2,443	2,726
	30 42	1	BR3042RE	1,583	1,583	1,664	2,125	2,479	2,257	2,655	3,115
	30 48	1	BR3048RE	1,863	1,863	1,954	2,420	2,805	2,564	2,994	3,433
	30 60	2	BR3060RE	2,258	2,258	2,361	2,864	3,303	3,028	3,520	4,175
	30 72	2	BR3072RE	2,367	2,367	2,490	2,984	3,484	3,166	3,721	4,659
	30 84	2	BR3084RE	2,736	2,736	2,841	3,136	3,913	3,333	4,205	4,951
	30 96	2	BR3096RE	2,849	2,849	2,963	3,287	4,188	3,502	4,514	5,244
	36 42	1	BR3642RE	1,659	1,659	1,751	2,215	2,605	2,362	2,794	3,456
	36 48	1	BR3648RE	1,946	1,946	2,043	2,522	2,938	2,676	3,141	3,784
	36 60	2	BR3660RE	2,936	2,936	3,051	3,528	4,000	3,705	4,235	5,172
	36 72	2	BR3672RE	3,067	3,067	3,189	3,732	4,265	3,931	4,534	5,733
	36 84	2	BR3684RE	3,456	3,456	3,567	3,897	4,639	4,121	4,953	6,290
	36 96	2	BR3696RE	3,587	3,587	3,719	4,066	4,917	4,309	5,265	6,839
	42 72	2	BR4272RE	3,645	3,645	3,750	4,281	4,909	4,393	5,058	-
42 84	2	BR4284RE	4,054	4,054	4,165	4,461	5,271	4,838	5,768	-	
42 96	2	BR4296RE	4,202	4,202	4,325	4,655	5,631	5,062	5,838	-	
48 96	2	BR4896RE	4,378	4,378	4,500	4,950	5,991	5,542	6,318	-	
48 120	2	BR48120RE	4,717	4,717	4,872	5,335	6,353	6,028	6,805	-	
	30 48	1	BR3048RR	1,863	1,863	1,954	2,420	2,805	2,564	2,994	3,433
	30 60	2	BR3060RR	2,258	2,258	2,361	2,864	3,303	3,028	3,520	4,175
	30 72	2	BR3072RR	2,367	2,367	2,490	2,984	3,484	3,166	3,721	4,659
	36 48	1	BR3648RR	1,946	1,946	2,043	2,522	2,938	2,676	3,141	3,784
	36 60	2	BR3660RR	2,936	2,936	3,051	3,528	4,000	3,705	4,235	5,172
	36 72	2	BR3672RR	3,067	3,067	3,189	3,732	4,265	3,931	4,534	5,733

How to Order

Table Model Number							Options	
BR Base Series	4896 Top Size	RD Top Shape	WWSQ Top Material Edge Profile	WMW Top Finish	N/A Edge Finish	MBM Base Finish	GMBM Matte Black Grommet	E Location "E"
A BR4896RAWWSQWMWMBM is a Brae series 48" x 96" racetrack table with two black powder coat bases and a wood veneer 1.25" thick top with a 1.25" square wood edge profile.						Edge finish applies when edge material is different from top material.	The code: GMBM specifies a matte black 2" diameter metal grommet.	The code: E specifies the location of the grommet.

BRAE DOUBLE – Dining & Multipurpose

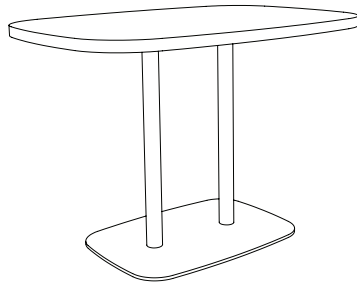

Laminate Surface

Wood Surface

Self Edge	Vinyl Edges	PVC Edges	Wood Edges Group A	Wood Edges Group B	Wood Edges Group A	Wood Edges Group B	Butcher Block
LLSE Self Edge	LVFL Flat	LPVC PVC	LWFL Flat	LWSQ Square	WWFL Flat	WWSQ Square	BBFL Flat
	LVBP Bumper		LWTP Tapered Ply	LWBN Bullnose	WWTP Tapered Ply	WWBN Bullnose	BBBN Bullnose
			LWFP Flat Ply	LWPR Prism	WWFP Flat Ply	WWPR Prism	

Complete Table List Pricing

	Top Size	Base Qty.	Model #									
Rectangle 	24 42	1	BRD2442RE	1,849	1,849	1,922	2,299	2,617	2,410	2,767	3,104	
	24 48	1	BRD2448RE	1,905	1,905	1,995	2,412	2,767	2,540	2,935	3,191	
	30 42	1	BRD3042RE	1,925	1,925	2,008	2,468	2,823	2,599	2,999	3,458	
	30 48	1	BRD3048RE	1,983	1,983	2,074	2,540	2,925	2,684	3,114	3,553	
	36 42	1	BRD3642RE	2,001	2,001	2,093	2,558	2,948	2,705	3,137	3,798	
	36 48	1	BRD3648RE	2,066	2,066	2,164	2,642	3,059	2,797	3,262	3,904	
RD Rectangle 	24 42	1	BRD2442RR	1,849	1,849	1,922	2,299	2,617	2,410	2,767	3,104	
	24 48	1	BRD2448RR	1,905	1,905	1,995	2,412	2,767	2,540	2,935	3,191	
	30 42	1	BRD3042RR	1,925	1,925	2,008	2,468	2,823	2,599	2,999	3,458	
	30 48	1	BRD3048RR	1,983	1,983	2,074	2,540	2,925	2,684	3,114	3,553	
	36 42	1	BRD3642RR	2,001	2,001	2,093	2,558	2,948	2,705	3,137	3,798	
	36 48	1	BRD3648RR	2,066	2,066	2,164	2,642	3,059	2,797	3,262	3,904	

How to Order

Table Model Number

BRD Base Series	4272 Top Size	RE Top Shape	WWSQ Top Material Edge Profile	WMW Top Finish	N/A Edge Finish	MBM Base Finish
---------------------------	-------------------------	------------------------	---	--------------------------	---------------------------	---------------------------

Options

GMBM Matte Black Grommet	E Location "E"
---------------------------------------	--------------------------

A BRD3648REWWSQWMWMBM is a Brae Double series 36" x 48" rectangle table with a black powder coat base and a wood veneer 1.25" thick top with a 1.25" square wood edge profile.

Edge finish applies when edge material is different from top material.







The code: GMBM specifies a matte black 2" diameter metal grommet.

The code: E specifies the location of the grommet.

Dining & Multipurpose – BRAE DOUBLE

Solid Surface

Quartz Surface

Corian®	Caesarstone® Q1	Okite® Q2
		
COFL Flat	Q1FL Flat	Q2FL Flat
		
COBN Bullnose	Q1BN Bullnose	Q2BN Bullnose
		
COPR Prism		

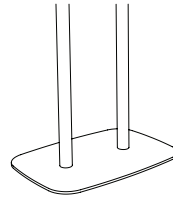

Double Column Base

Options

Base Finishes

Custom Powder Coat (set-up charge)	CPC	770
Polished or Satin Chrome (per base)	use finish code	1,430
Premium Plated (per base)	use finish code	1,650
Stainless Steel (per base)	use finish code	1,650

Base Options

Counter, Bar, & Alternate Height (per column)	CH, BH, AH	76
Nylon Octagon Glides (per base)	GNO	40
Custom Top Plate Size	CTPS	770
6" Column (black texture and powder coat)	COL6	224
6" Column (polished or satin chrome)	COLP6	286
6" Column (premium plated)	COLPP6	770
6" Column (veneer)	COLV6	446
Base sizes may vary with quartz tops		

Top Materials and Finishes

Any non-standard WCI Laminates (set-up charge)	use manufacturers finish code	165
Premium Laminates	PL	770
Custom Wood Veneer	CWV	770
Stain to Match (set-up charge)	STM	476

Top Options

3" Radius Corner (per corner) (laminate self edge, Ultrafoam, Corian®, 3form® Chroma®)	CRL3	40
3" Wood Radius Corner (per corner) (not available in LWFL and WWFL)	CRW3	95
Custom Size	CS	770
Custom Radius Corner	CRC	95
Custom Shape	CSH	770
Custom Edge Thickness	CET	770

Grommets

2" Round Metal Grommet - Matte Black	GMBM	160
2" Round Metal Grommet - Satin Chrome	GMSC	160
2" Round Metal Grommet - Polished Chrome	GMPC	160
2" Round Plastic Grommet - Matte Black	GPMBM	65
Grommet location	use location code	n/c

2,948	3,894	6,536
3,127	-	-
3,248	4,442	7,245
3,491	-	-
3,853	5,134	8,413
4,376	-	-
2,948	3,894	6,536
3,127	-	-
3,248	4,442	7,245
3,491	-	-
3,853	5,134	8,413
4,376	-	-

📞 Call for pricing

844.815.2217

CANVAS

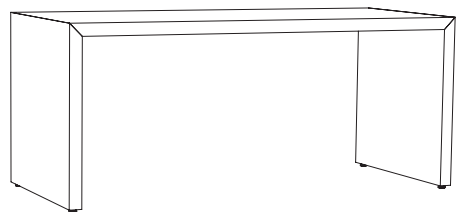
	Laminate	Overlay	Clad	Wood	Overlay	Clad
	Laminate LAM Laminate	Corian® OLCLAM Corian®	Corian® CDCLAM Corian® Clad	Veneer VEN Wood Veneer	Corian® OLCVEN Corian®	Corian® CDCVEN Corian® Clad

Complete Table List Pricing

Rectangle	Top Size		Model #	3,946	5,100	7,555	4,830	5,918	8,297
	24	60							
	24	72	CA2472RE	4,352	5,756	8,301	5,322	6,672	9,132
	24	84	CA2484RE	4,800	6,459	9,107	5,877	7,491	10,034
	24	96	CA2496RE	5,326	7,222	9,970	6,486	8,367	10,990
	24	120	CA24120RE	6,237	8,670	11,527	7,512	9,948	12,734
	30	60	CA3060RE	4,368	5,767	8,468	5,293	6,529	9,224
	30	72	CA3072RE	4,817	6,518	9,304	5,832	7,373	10,149
	30	84	CA3084RE	5,311	7,314	10,198	6,434	8,284	11,141
	30	96	CA3096RE	5,877	8,171	11,152	7,091	9,250	12,187
	30	120	CA30120RE	6,874	9,807	12,885	8,210	11,012	14,111
	36	60	CA3660RE	4,841	6,817	10,071	5,820	7,580	11,002
	36	72	CA3672RE	5,333	7,718	11,063	6,408	8,559	12,085
	36	84	CA3684RE	5,869	8,646	12,112	7,057	9,620	13,233
	36	96	CA3696RE	6,478	9,657	13,222	7,759	10,743	14,438
	36	120	CA36120RE	7,520	11,584	15,259	8,967	12,790	16,663
	42	60	CA4260RE	5,313	7,541	11,174	6,349	8,271	12,136
	42	72	CA4272RE	5,848	8,518	12,255	6,982	9,341	13,309
	42	84	CA4284RE	6,427	9,566	13,394	7,679	10,502	14,549
	42	96	CA4296RE	7,081	10,682	14,593	8,428	11,727	15,843
	42	120	CA42120RE	8,182	12,790	16,808	9,713	13,910	18,236

How to Order

Table Model Number

CA	3684	RE	OLCVEN	WNW	CGW
Table Series	Top Size	Top Shape	Material & Style	Wood Veneer Finish	Corian Overlay

Options

MIN2-B
Specified power unit.

A CA3684REOLCVENWNWCGW is a Canvas series 36" x 84" standard height rectangle table in Natural Walnut wood veneer with a Corian® Glacier White overlay top.

MIN2-B is an in-surface power unit with one power and one USB charger.

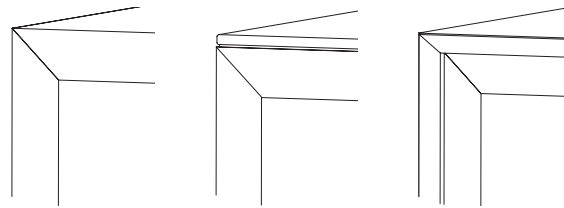

Overlay

Clad

Options

Base Options

Counter & Bar Height	CH & BH	pages 69-70
Alternate Height	AH	

Top Materials and Finishes

Any non-standard WCI Laminates (set-up charge)	use manufacturers finish code	165
Premium Laminates	PL	
Custom Wood Veneer	CWV	
Custom Overlay Material	NSF	
Stain to Match (set-up charge)	STM	476

Top Options

Custom Size	CS	
-------------	----	--

Power, Data, & Wire Management

Wire Management	Pages 134 -235
Power & Data	Pages 236-237

Call for pricing

844.815.2217

CANVAS— Counter

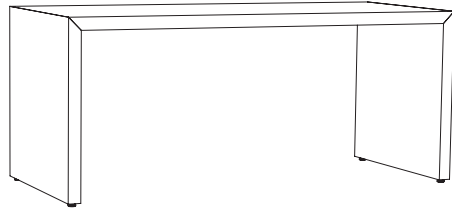

Laminate	Overlay	Clad	Wood	Overlay	Clad
Laminate LAM Laminate	Corian® OLCLAM Corian®	Corian® CDCLAM Corian® Clad	Veneer VEN Wood Veneer	Corian® OLCVEN Corian®	Corian® CDCVEN Corian® Clad

Complete Table List Pricing

Rectangle	Top Size		Model #	Pricing					
	Width	Depth		Laminate	Overlay	Clad	Wood	Overlay	Clad
	24	60	CA2460RE	4,200	5,330	8,198	5,128	6,141	8,985
	24	72	CA2472RE	4,605	5,986	8,945	5,620	6,896	9,820
	24	84	CA2484RE	5,055	6,689	9,750	6,175	7,717	10,721
	24	96	CA2496RE	5,579	7,454	10,615	6,786	8,592	11,679
	24	120	CA24120RE	6,490	8,902	12,163	7,844	10,173	13,411
	30	60	CA3060RE	4,672	6,045	9,217	5,645	6,789	10,018
	30	72	CA3072RE	5,121	6,794	10,052	6,184	7,633	10,943
	30	84	CA3084RE	5,614	7,590	10,946	6,788	8,544	11,934
	30	96	CA3096RE	6,181	8,448	11,900	7,444	9,511	12,981
	30	120	CA30120RE	7,178	10,084	13,627	8,622	11,276	14,895
	36	60	CA3660RE	5,195	7,140	10,923	6,229	7,876	11,936
	36	72	CA3672RE	5,687	8,040	11,915	6,816	8,855	13,019
	36	84	CA3684RE	6,223	8,967	12,965	7,465	9,915	14,168
	36	96	CA3696RE	6,832	9,979	14,075	8,169	11,039	15,373
	36	120	CA36120RE	7,874	11,906	16,105	9,436	13,089	17,587
	42	60	CA4260RE	5,718	7,909	12,130	6,812	8,602	13,176
	42	72	CA4272RE	6,252	8,887	13,210	7,446	9,672	14,348
	42	84	CA4284RE	6,832	9,934	14,351	8,141	10,834	15,588
	42	96	CA4296RE	7,486	11,048	15,549	8,891	12,058	16,883
	42	120	CA42120RE	8,587	13,127	17,705	10,195	14,253	19,268

How to Order

Table Model Number

CA Table Series	3684 Top Size	RE Top Shape	OLCVEN Material & Style	WNW Wood Veneer Finish	CGW Corian Overlay
--------------------	------------------	-----------------	----------------------------	------------------------------	--------------------------

Options

BH Bar Height	MIN2-A Specified power unit.
------------------	---------------------------------

A CA3684REOLCVENWNWCGW-BH-MIN2-A is a Canvas series 36" x 84" bar height rectangle table in Natural Walnut wood veneer with a Corian® Glacier White overlay top with a Byrne® Mini-Tap® on surface power unit.

To specify Counter Height use code CH.

MIN2-B is an in-surface power unit with one power and one USB charger.

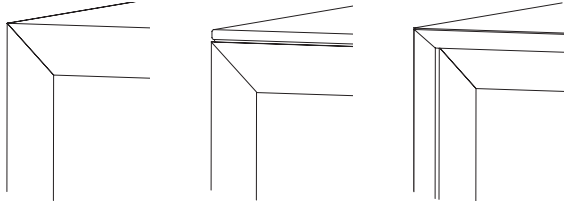

Overlay

Clad

Options

Top Materials and Finishes		
Any non-standard WCI Laminates (set-up charge)	use manufacturers finish code	165
Premium Laminates	PL	📞
Custom Wood Veneer	CWV	📞
Custom Overlay Material	NSF	📞
Stain to Match (set-up charge)	STM	476
Top Options		
Custom Size	CS	📞
Power, Data, & Wire Management		
Wire Management		Pages 134 -235
Power & Data		Pages 236-237

📞 Call for pricing

844.815.2217

CANVAS— Bar Height

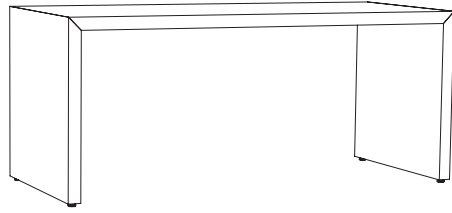

Laminate	Overlay	Clad	Wood	Overlay	Clad
Laminate LAM Laminate	Corian® OLCLAM Corian®	Corian® CDCLAM Corian® Clad	Veneer VEN Wood Veneer	Corian® OLCVEN Corian®	Corian® CDCVEN Corian® Clad

Complete Table List Pricing

Rectangle	Top Size		Model #	Pricing					
	24	30		4,424	5,534	8,786	5,394	7,851	9,887
	24	60	CA2460RE	4,424	5,534	8,786	5,394	7,851	9,887
	24	72	CA2472RE	4,830	6,191	9,533	5,885	8,713	10,729
	24	84	CA2484RE	5,280	6,893	10,338	6,442	9,642	11,637
	24	96	CA2496RE	5,804	7,657	11,202	7,050	10,626	12,601
	24	120	CA24120RE	6,714	9,106	12,698	8,129	12,425	14,337
	30	60	CA3060RE	4,940	6,288	9,892	5,959	8,941	11,125
	30	72	CA3072RE	5,389	7,037	10,728	6,497	9,929	12,067
	30	84	CA3084RE	5,883	7,833	11,623	7,099	10,982	13,075
	30	96	CA3096RE	6,449	8,691	12,575	7,756	12,092	14,137
	30	120	CA30120RE	7,446	10,326	14,251	8,954	14,144	16,080
	36	60	CA3660RE	5,506	7,422	11,689	6,588	10,472	13,281
	36	72	CA3672RE	5,997	8,323	12,679	7,174	11,628	14,389
	36	84	CA3684RE	6,534	9,250	13,730	7,824	12,867	15,563
	36	96	CA3696RE	7,143	10,262	14,840	8,527	14,167	16,794
	36	120	CA36120RE	8,183	12,188	16,818	9,814	16,570	19,056
	42	60	CA4260RE	6,071	8,230	12,984	7,218	11,641	14,727
	42	72	CA4272RE	6,606	9,207	14,065	7,852	12,923	15,936
	42	84	CA4284RE	7,185	10,255	15,204	8,549	14,297	17,211
	42	96	CA4296RE	7,838	11,370	16,403	9,298	15,733	18,539
	42	120	CA42120RE	8,941	13,448	18,560	10,610	17,356	20,989

How to Order

Table Model Number

CA Table Series	3684 Top Size	RE Top Shape	OLCVEN Material & Style	WNW Wood Veneer Finish	CGW Corian Overlay
--------------------	------------------	-----------------	----------------------------	------------------------------	--------------------------

Options

BH Bar Height	MIN2-A Specified power unit.
------------------	---------------------------------

A CA3684REOLCVENWNWCGW-BH-MIN2-A is a Canvas series 36" x 84" bar height rectangle table in Natural Walnut wood veneer with a Corian® Glacier White overlay top with a Byrne® Mini-Tap® on surface power unit.

To specify Counter Height use code CH.

MIN2-B is an in-surface power unit with one power and one USB charger.

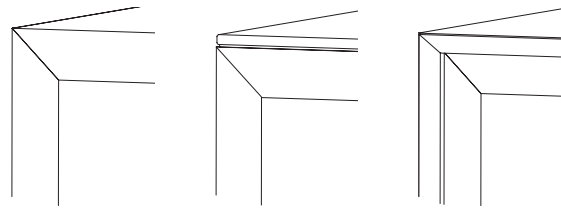

Overlay

Clad

Options

Top Materials and Finishes

Any non-standard WCI Laminates (set-up charge)	use manufacturers finish code	165
Premium Laminates	PL	📞
Custom Wood Veneer	CWV	📞
Custom Overlay Material	NSF	📞
Stain to Match (set-up charge)	STM	476

Top Options

Custom Size	CS	📞
-------------	----	---











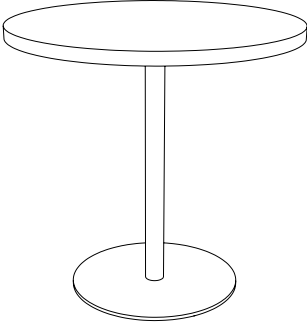







Power, Data, & Wire Management

Wire Management	Pages 134 -235
Power & Data	Pages 236-237





📞 Call for pricing

844.815.2217

DISC – Dining & Multipurpose

	Laminate Surface				Wood Surface			
	Self Edge	Vinyl Edges	PVC Edges	Wood Edges Group A	Wood Edges Group B	Wood Edges Group A	Wood Edges Group B	Butcher Block
	 LSE Self Edge	 LVFL Flat	 LPVC PVC	 LWFL Flat	 LWSQ Square	 WWFL Flat	 WWSQ Square	 BBFL Flat
		 LVBP Bumper		 LWTP Tapered Ply	 LWBN Bullnose	 WWTP Tapered Ply	 WWBN Bullnose	 BBBN Bullnose
				 LWFP Flat Ply	 LWPR Prism	 WWFP Flat Ply	 WWPR Prism	

Complete Table List Pricing

	Top Size		Base Qty.	Model #								
Round 	24		1	DI24RD	1,076	1,076	1,155	1,408	1,676	1,423	1,791	1,658
	30		1	DI30RD	1,173	1,173	1,271	1,587	1,874	1,697	2,014	2,049
	36		1	DI36RD	1,585	1,585	1,701	2,075	2,407	2,115	2,574	2,824
	42		1	DI42RD	1,746	1,746	1,874	2,258	2,670	2,407	2,869	3,660
	48		1	DI48RD	2,133	2,133	2,277	2,702	3,174	2,879	3,410	4,320
	54		1	DI54RD	2,310	2,310	2,477	3,046	4,021	3,266	4,360	-
	60		1	DI60RD	2,591	2,591	2,771	3,236	4,150	3,809	4,510	-
Oval 	36	72	2	DI3672OV	2,544	2,544	2,625	2,957	3,311	3,231	3,575	-
	42	54	2	DI4254OV	2,507	2,507	2,551	2,877	3,397	3,116	3,494	-
	42	78	2	DI4278OV	3,544	3,544	3,610	3,918	4,268	4,145	4,536	-
	42	84	2	DI4284OV	3,633	3,633	3,719	3,997	4,397	4,230	4,682	-
	48	78	2	DI4878OV	4,134	4,134	4,225	4,494	4,891	4,737	5,182	-
	48	96	2	DI4896OV	4,414	4,414	4,503	4,730	5,162	5,306	5,811	-
RD Square 	24	24	1	DI2424RS	1,077	1,077	1,165	1,407	1,676	1,423	1,791	1,769
	30	30	1	DI3030RS	1,173	1,173	1,279	1,587	1,874	1,697	2,014	2,197
	36	36	1	DI3636RS	1,585	1,585	1,693	2,057	2,407	2,115	2,574	3,011
	42	42	1	DI4242RS	1,726	1,726	1,848	2,258	2,670	2,407	2,869	3,953
	48	48	1	DI4848RS	2,135	2,135	2,277	2,703	3,174	2,880	3,411	4,664
Square 	24	24	1	DI2424SQ	1,077	1,077	1,165	1,407	1,676	1,423	1,791	1,769
	30	30	1	DI3030SQ	1,173	1,173	1,279	1,587	1,874	1,697	2,014	2,197
	36	36	1	DI3636SQ	1,585	1,585	1,693	2,057	2,407	2,115	2,574	3,011
	42	42	1	DI4242SQ	1,726	1,726	1,848	2,258	2,670	2,407	2,869	3,953
	48	48	1	DI4848SQ	2,135	2,135	2,277	2,703	3,174	2,880	3,411	4,664

Continued on next page

How to Order

Table Model Number							Options	
DI Base Series	4896 Top Size	RA Top Shape	WWSQ Top Material Edge Profile	WMW Top Finish	N/A Edge Finish	MBM Base Finish	GMBM Matte Black Grommet	E Location "E"
A DI4896RAWWSQWMWMBM is a Disc series 48" x 96" racetrack table with two black powder coat round bases and a wood veneer 1.25" thick top with a 1.25" square wood edge profile.					Edge finish applies when edge material is different from top material.		The code: GMBM specifies a matte black 2" diameter metal grommet.	The code: E specifies the location of the grommet.

DISC – Dining & Multipurpose

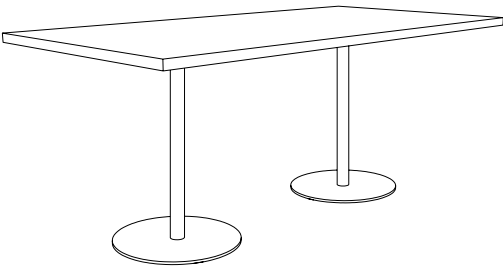







Laminate Surface				Wood Surface			
Self Edge	Vinyl Edges	PVC Edges	Wood Edges Group A	Wood Edges Group B	Wood Edges Group A	Wood Edges Group B	Butcher Block
LLSE Self Edge	LVFL Flat	LPVC PVC	LWFL Flat	LWSQ Square	WWFL Flat	WWSQ Square	BBFL Flat
	LVBP Bumper		LWTP Tapered Ply	LWBN Bullnose	WWTP Tapered Ply	WWBN Bullnose	BBBN Bullnose
			LWFP Flat Ply	LWPR Prism	WWFP Flat Ply	WWPR Prism	

Complete Table List Pricing

	Top Size		Base Qty.	Model #								
<div style="border: 1px solid black; width: 40px; height: 60px; margin-bottom: 10px;"></div> Rectangle	24	30	1	DI2430RE	1,123	1,123	1,198	1,505	1,801	1,632	1,928	1,955
	24	36	1	DI2436RE	1,454	1,454	1,538	1,890	2,178	1,995	2,320	2,454
	24	42	1	DI2442RE	1,506	1,506	1,579	1,956	2,274	2,067	2,424	2,761
	24	48	1	DI2448RE	1,563	1,563	1,652	2,070	2,424	2,198	2,592	2,849
	24	60	2	DI2460RE	2,151	2,151	2,246	2,694	3,097	2,835	3,288	3,737
	24	72	2	DI2472RE	2,242	2,242	2,354	2,849	3,309	3,012	3,530	4,135
	24	84	2	DI2484RE	2,588	2,588	2,692	2,979	3,757	3,159	4,035	4,428
	24	96	2	DI2496RE	2,680	2,680	2,795	3,110	3,949	3,303	4,250	4,719
	30	36	1	DI3036RE	1,526	1,526	1,597	1,976	2,290	2,090	2,443	2,726
	30	42	1	DI3042RE	1,583	1,583	1,665	2,125	2,479	2,257	2,655	3,115
	30	48	1	DI3048RE	1,863	1,863	1,953	2,420	2,804	2,565	2,994	3,433
	30	60	2	DI3060RE	2,258	2,258	2,360	2,864	3,303	3,028	3,520	4,175
	30	72	2	DI3072RE	2,367	2,367	2,490	2,984	3,484	3,166	3,721	4,660
	30	84	2	DI3084RE	2,737	2,737	2,841	3,136	3,913	3,333	4,204	4,951
	30	96	2	DI3096RE	2,849	2,849	2,963	3,287	4,188	3,504	4,514	5,243
	36	42	1	DI3642RE	1,658	1,658	1,751	2,214	2,604	2,362	2,794	3,456
	36	48	1	DI3648RE	1,946	1,946	2,044	2,522	2,939	2,676	3,142	3,783
	36	60	2	DI3660RE	2,936	2,936	3,050	3,528	4,000	3,705	4,235	5,173
	36	72	2	DI3672RE	3,067	3,067	3,190	3,732	4,265	3,931	4,534	5,733
	36	84	2	DI3684RE	3,456	3,456	3,567	3,898	4,639	4,121	4,953	6,290
	36	96	2	DI3696RE	3,587	3,587	3,719	4,066	4,917	4,309	5,265	6,839
	42	72	2	DI4272RE	3,647	3,647	3,750	4,281	4,910	4,392	5,058	-
	42	84	2	DI4284RE	4,052	4,052	4,165	4,461	5,271	4,838	5,768	-
	42	96	2	DI4296RE	4,203	4,203	4,325	4,655	5,631	5,063	5,838	-
48	96	2	DI4896RE	4,379	4,379	4,499	4,950	5,991	5,542	6,318	-	
48	120	2	DI48120RE	4,717	4,717	4,872	5,335	6,353	6,028	6,805	-	

How to Order

Table Model Number							Options	
DI Base Series	3642 Top Size	RE Top Shape	WWSQ Top Material Edge Profile	WMW Top Finish	N/A Edge Finish	MBM Base Finish	GMBM Matte Black Grommet	E Location "E"
A DI3642REWWSQWMWMBM is a Disc series 36" x 42" rectangle table with a black powder coat round base and a wood veneer 1.25" thick top with a 1.25" square wood edge profile.						Edge finish applies when edge material is different from top material.	The code: GMBM specifies a matte black 2" diameter metal grommet.	The code: E specifies the location of the grommet.

Solid Surface	Quartz Surface	
Corian®	Caesarstone® Q1	Okite® Q2
		
COFL Flat	Q1FL Flat	Q2FL Flat
		
COBN Bullnose	Q1BN Bullnose	Q2BN Bullnose
		
COPR Prism		

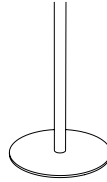

Options

Base Finishes

Custom Powder Coat (set-up charge)	CPC	660
Polished or Satin Chrome (per base)	use finish code	1,430
Premium Plated (per base)	use finish code	1,650
Stainless Steel (per base)	use finish code	1,650

Base Options

Counter, Bar, & Alternate Height (per column)	CH, BH, AH	76
Nylon Octagon Glides (per base)	GNO	40
Custom Top Plate Size	CTPS	660
6" Column (black texture and powder coat)	COL6	224
6" Column (polished or satin chrome)	COLP6	286
6" Column (premium plated)	COLPP6	660
6" Column (veneer)	COLV6	446
Base sizes may vary with quartz tops		

Top Materials and Finishes

Any non-standard WCI Laminates (set-up charge)	use manufacturers finish code	165
Premium Laminates	PL	660
Custom Wood Veneer	CWV	660
Stain to Match (set-up charge)	STM	476

Top Options

3" Radius Corner (per corner) (laminate self edge, Ultrafoam, Corian®, 3form® Chroma®)	CRL3	40
3" Wood Radius Corner (per corner) (not available in LWFL and WWFL)	CRW3	95
Custom Size	CS	660
Custom Radius Corner	CRC	95
Custom Shape	CSH	660
Custom Edge Thickness	CET	660

Grommets

2" Round Metal Grommet - Matte Black	GMBM	160
2" Round Metal Grommet - Satin Chrome	GMSC	160
2" Round Metal Grommet - Polished Chrome	GMPC	160
2" Round Plastic Grommet - Matte Black	GPMBM	51
Grommet location	use location code	n/c

	1,961	2,629	5,023
	2,427	3,179	5,840
	2,604	3,551	6,193
	2,784	-	-
	3,665	-	-
	4,045	-	-
	-	-	-
	-	-	-
	2,686	3,853	6,724
	2,906	4,099	6,901
	3,370	-	-
	4,093	-	-
	4,549	-	-
	-	-	-
	-	-	-
	3,511	4,791	8,069
	4,255	-	-
	5,129	-	-
	5,651	-	-
	-	-	-
	-	-	-
	-	-	-
	-	-	-
	-	-	-
	-	-	-
	-	-	-
	-	-	-

Call for pricing

844.815.2217

DUNHILL – Dining & Multipurpose



Laminate Surface

Wood Surface

Self Edge	Vinyl Edges	PVC Edges	Wood Edges Group A	Wood Edges Group B	Wood Edges Group A	Wood Edges Group B	Butcher Block
LLSE Self Edge	LVFL Flat	LPVC PVC	LWFL Flat	LWSQ Square	WWFL Flat	WWSQ Square	BBFL Flat
	LVBP Bumper		LWTP Tapered Ply	LWBN Bullnose	WWTP Tapered Ply	WWBN Bullnose	BBBN Bullnose
			LWFP Flat Ply	LWPR Prism	WWFP Flat Ply	WWPR Prism	

Complete Table List Pricing

	Top Size		Base Qty.	Base Style	Model #								
Round 	24		1	X	DUX24RD	1,139	1,139	1,218	1,471	1,739	1,486	1,855	1,720
	30		1	X	DUX30RD	1,356	1,356	1,453	1,771	2,058	1,881	2,198	2,233
	36		1	X	DUX36RD	1,601	1,601	1,715	2,090	2,422	2,131	2,589	2,839
	42		1	X	DUX42RD	1,761	1,761	1,890	2,274	2,684	2,422	2,884	3,675
	48		1	X	DUX48RD	2,044	2,044	2,189	2,614	3,086	2,791	3,322	4,232
	54		1	XH	DUXH54RD	2,335	2,335	2,503	3,071	4,046	3,291	4,386	-
	60		1	XH	DUXH60RD	2,616	2,616	2,796	3,262	4,176	3,835	4,535	-
Oval 	36	72	2	T	DUT3672OV	2,206	2,206	2,286	2,617	2,971	2,892	3,236	-
	42	54	2	T	DUT4254OV	2,168	2,168	2,212	2,538	3,058	2,778	3,155	-
	42	78	2	T	DUT4278OV	2,633	2,633	2,699	3,007	3,357	3,234	3,626	-
	42	84	2	T	DUT4284OV	2,723	2,723	2,808	3,087	3,486	3,319	3,771	-
	48	78	2	TT	DUTT4878OV	2,980	2,980	3,072	3,340	3,737	3,584	4,028	-
	48	96	2	TT	DUTT4896OV	3,260	3,260	3,350	3,576	4,008	4,153	4,657	-
RD Square 	24	24	1	X	DUX2424RS	1,141	1,141	1,229	1,471	1,740	1,486	1,855	1,832
	30	30	1	X	DUX3030RS	1,355	1,355	1,463	1,771	2,058	1,881	2,197	2,380
	36	36	1	X	DUX3636RS	1,601	1,601	1,708	2,072	2,422	2,131	2,589	3,026
	42	42	1	X	DUX4242RS	1,860	1,860	1,982	2,393	2,804	2,541	3,003	4,088
	48	48	1	X	DUX4848RS	2,047	2,047	2,189	2,614	3,086	2,791	3,322	4,576
Square 	24	24	1	X	DUX2424SQ	1,141	1,141	1,229	1,471	1,740	1,486	1,855	1,832
	30	30	1	X	DUX3030SQ	1,355	1,355	1,463	1,771	2,058	1,881	2,197	2,380
	36	36	1	X	DUX3636SQ	1,601	1,601	1,708	2,072	2,422	2,131	2,589	3,026
	42	42	1	X	DUX4242SQ	1,860	1,860	1,982	2,393	2,804	2,541	3,003	4,088
	48	48	1	X	DUX4848SQ	2,047	2,047	2,189	2,614	3,086	2,791	3,322	4,576

Continued on next page

How to Order

Table Model Number

Options

DUX Base Series **36** Top Size **RD** Top Shape **WWSQ** Top Material Edge Profile **WMW** Top Finish **N/A** Edge Finish **MBM** Base Finish

AH Alternate Height Base

A DUX36RDWWSQWMWMBM is a Dunhill series 36" round table with a black powder coat X-base and a wood veneer 1.25" thick top with a 1.25" square wood edge profile.

Edge finish applies when edge material is different from top material.

The code: AH specifies alternate height base.

Solid Surface

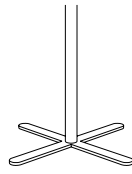
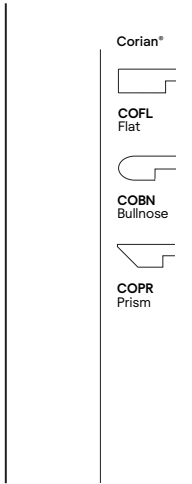

X, XH Base

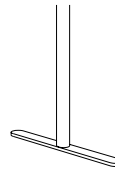

T Base

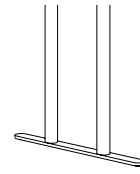

TT Base

1,975
2,529
3,199
3,823
4,648
5,533
6,410
-
-
-
-
-
-
-
-
-
-
-
-
1,840
2,361
3,012
3,717
4,403

Options

Base Finishes

Custom Powder Coat (set-up charge)	CPC	☎
Polished or Satin Chrome (per X base)	use finish code	413
Polished or Satin Chrome (T & TT base, per column)	use finish code	207
Premium Plated (per X base)	use finish code	715
Premium Plated (T & TT base, per column)	use finish code	385
Stainless Steel (per base)	use finish code	1,650

Base Options

Counter, Bar, & Alternate Height (per column)	CH, BH, AH	76
Super Level Glides (per base)	GSL	40
Locking Casters 2" Twin Wheel (qty. 4)	TWC2	65
Tilt-top - (standard cable release)	TMX/TMT	312 X-base/ 483 T-base
Folding	FM	312 T-base

Top Materials and Finishes

Any non-standard WCI Laminates (set-up charge)	use manufacturers finish code	165
Premium Laminates	PL	☎
Custom Wood Veneer	CWV	☎
Stain to Match (set-up charge)	STM	476

Top Options

3" Radius Corner (per corner)	CRL3	40
(laminates self edge, Ultrafoam, Corian®, 3form® Chroma®)		
3" Wood Radius Corner (per corner)	CRW3	95
(not available in LWFL and WWFL)		
Custom Radius Corner	CRC	95
Custom Size	CS	☎
Custom Shape	CSH	☎
Custom Edge Thickness	CET	☎
Ganging Clips (1 set includes 2 male and 2 female clips)	GC	171

Grommets

2" Round Metal Grommet - Matte Black	GMBM	160
2" Round Metal Grommet - Satin Chrome	GMSC	160
2" Round Metal Grommet - Polished Chrome	GMPC	160
2" Round Plastic Grommet - Matte Black	GPMBM	51
Grommet location	use location code	n/c

Power, Data, & Wire Management

Wire management	Pages 234-235
Power & data	Pages 236-237

☎ Call for pricing

844.815.2217

DUNHILL – Dining & Multipurpose

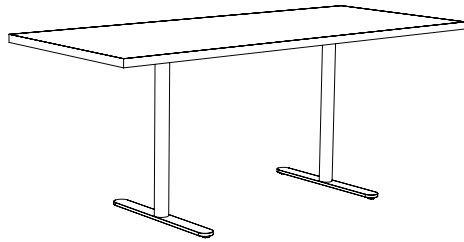

Laminate Surface

Wood Surface

Self Edge	Vinyl Edges	PVC Edges	Wood Edges Group A	Wood Edges Group B	Wood Edges Group A	Wood Edges Group B	Butcher Block
LLSE Self Edge	LVFL Flat	LPVC PVC	LWFL Flat	LWSQ Square	WWFL Flat	WWSQ Square	BBFL Flat
	LVBP Bumper		LWTP Tapered Ply	LWBN Bullnose	WWTP Tapered Ply	WWBN Bullnose	BBBN Bullnose
			LWFP Flat Ply	LWPR Prism	WWFP Flat Ply	WWPR Prism	

Complete Table List Pricing

	Top Size	Base Qty.	Base Style	Model #								
Rectangle	18 48	2	T	DUT1848RE	1,404	1,404	1,484	1,671	2,068	1,775	2,113	2,247
	18 60	2	T	DUT1860RE	1,482	1,482	1,577	1,799	2,247	1,901	2,340	2,355
	18 72	2	T	DUT1872RE	1,557	1,557	1,661	1,933	2,428	2,041	2,565	2,537
	18 84	2	T	DUT1884RE	1,799	1,799	1,881	2,163	2,653	2,313	2,861	2,789
	18 96	2	T	DUT1896RE	1,933	1,933	2,006	2,255	2,833	2,412	3,027	2,969
	24 30	1	X	DUX2430RE	1,306	1,306	1,382	1,689	1,984	1,816	2,112	2,137
	24 36	1	X	DUX2436RE	1,469	1,469	1,552	1,905	2,193	2,010	2,334	2,470
	24 42	1	X	DUX2442RE	1,521	1,521	1,594	1,970	2,289	2,082	2,440	2,776
	24 48	1	X	DUX2448RE	1,579	1,579	1,668	2,086	2,440	2,213	2,607	2,864
	24 60	2	T	DUT2460RE	1,586	1,586	1,682	2,130	2,532	2,270	2,724	3,172
	24 72	2	T	DUT2472RE	1,679	1,679	1,790	2,285	2,745	2,448	2,966	3,571
	24 84	2	T	DUT2484RE	2,024	2,024	2,127	2,415	3,192	2,595	3,471	3,863
	24 96	2	T	DUT2496RE	2,116	2,116	2,231	2,545	3,386	2,739	3,686	4,155
	30 36	1	X	DUX3036RE	1,541	1,541	1,613	1,990	2,305	2,105	2,457	2,741
	30 42	2	T	DUT3042RE	1,617	1,617	1,700	2,159	2,514	2,291	2,690	3,150
	30 48	1	X	DUX3048RE	1,775	1,775	1,865	2,332	2,716	2,476	2,905	3,345
	30 60	2	T	DUT3060RE	1,803	1,803	1,904	2,409	2,848	2,573	3,065	3,719
	30 72	2	T	DUT3072RE	1,912	1,912	2,035	2,529	3,028	2,710	3,266	4,204
	30 84	2	T	DUT3084RE	2,281	2,281	2,386	2,681	3,457	2,878	3,749	4,496
	30 96	2	T	DUT3096RE	2,394	2,394	2,508	2,831	3,732	3,048	4,059	4,787
	36 42	2	T	DUT3642RE	1,808	1,808	1,902	2,365	2,754	2,512	2,945	3,606
	36 48	2	T	DUT3648RE	1,873	1,873	1,971	2,450	2,867	2,605	3,069	3,711
	36 60	2	T	DUT3660RE	2,025	2,025	2,140	2,617	3,089	2,794	3,324	4,263
	36 72	2	T	DUT3672RE	2,156	2,156	2,279	2,822	3,354	3,021	3,623	4,822
	36 84	2	T	DUT3684RE	2,545	2,545	2,657	2,988	3,728	3,210	4,043	5,379
	36 96	2	TT	DUTT3696RE	2,879	2,879	3,011	3,357	4,209	3,600	4,556	6,130

Continued on next page

*T-bases can be specified on 30" x 42" and 30" x 48" rectangle tables, please refer to Base Only Pricing and Top Only Pricing.

X-bases are recommended for dining applications.

How to Order

Table Model Number							Options
DUT Base Series	3672 Top Size	RA Top Shape	WWSQ Top Material Edge Profile	WMW Top Finish	N/A Edge Finish	MBM Base Finish	TWC2 Casters

A DUT3672RAWWSQWMWMBM is a Dunhill series 36"x 72" racetrack table with two black powder coated T-bases and a wood veneer 1.25" thick top with a 1.25" square wood edge profile.

Edge finish applies when edge material is different from top material.

The code: TWC2 specifies 2" twin wheel locking casters.

Solid Surface

Corian®	
COFL Flat	
COBN Bullnose	
COPR Prism	
-	
-	
-	
-	
-	
2,145	
2,442	
2,619	
2,800	
3,101	
3,480	
-	
-	
2,702	
2,940	
3,282	
3,638	
4,093	
-	
-	
3,662	
4,183	
4,219	
4,740	
-	
-	

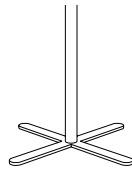

X, XH Base

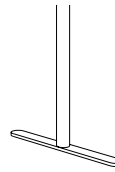

T Base

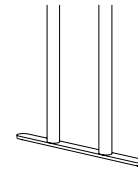

TT Base

Options

Base Finishes

Custom Powder Coat (set-up charge)	CPC	☎
Polished or Satin Chrome (per X base)	use finish code	413
Polished or Satin Chrome (T & TT base, per column)	use finish code	207
Premium Plated (per X base)	use finish code	715
Premium Plated (T & TT base, per column)	use finish code	385
Stainless Steel (per base)	use finish code	1,650

Base Options

Counter, Bar, & Alternate Height (per column)	CH, BH, AH	76
Super Level Glides (per base)	GSL	40
Locking Casters 2" Twin Wheel (qty. 4)	TWC2	65
Tilt-top - (standard cable release)	TMX/TMT	312 X-base/ 483 T-base
Folding	FM	312 T-base

Top Materials and Finishes

Any non-standard WCI Laminates (set-up charge)	use manufacturers finish code	165
Premium Laminates	PL	☎
Custom Wood Veneer	CWV	☎
Stain to Match (set-up charge)	STM	476

Top Options

3" Radius Corner (per corner) (laminare self edge, Ultrafoam, Corian®, 3form® Chroma®)	CRL3	40
3" Wood Radius Corner (per corner) (not available in LWFL and WWFL)	CRW3	95
Custom Radius Corner	CRC	95
Custom Size	CS	☎
Custom Shape	CSH	☎
Custom Edge Thickness	CET	☎
Ganging Clips (1 set includes 2 male and 2 female clips)	GC	171

Grommets

2" Round Metal Grommet - Matte Black	GMBM	160
2" Round Metal Grommet - Satin Chrome	GMSC	160
2" Round Metal Grommet - Polished Chrome	GMPC	160
2" Round Plastic Grommet - Matte Black	GPMBM	51
Grommet location	use location code	n/c











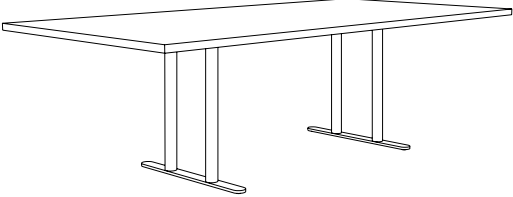







Power, Data, & Wire Management

Wire management	Pages 234-235
Power & data	Pages 236-237

☎ Call for pricing

844.815.2217

DUNHILL – Dining & Multipurpose

	Laminate Surface				Wood Surface			
	Self Edge	Vinyl Edges	PVC Edges	Wood Edges Group A	Wood Edges Group B	Wood Edges Group A	Wood Edges Group B	Butcher Block
	 LLSE Self Edge	 LVFL Flat	 LPVC PVC	 LWFL Flat	 LWSQ Square	 WWFL Flat	 WWSQ Square	 BBFL Flat
		 LVBP Bumper		 LWTP Tapered Ply	 LWBN Bullnose	 WWTP Tapered Ply	 WWBN Bullnose	 BBBN Bullnose
				 LWFP Flat Ply	 LWPR Prism	 WWFP Flat Ply	 WWPR Prism	





Complete Table List Pricing

	Top Size	Base Qty.	Base Style	Model #								
Rectangle 	42 72	2	TT	DUTT4272RE	2,493	2,493	2,596	3,127	3,757	3,240	3,904	-
	42 84	2	TT	DUTT4284RE	2,900	2,900	3,011	3,307	4,117	3,684	4,615	-
	42 96	2	TT	DUTT4296RE	3,049	3,049	3,171	3,501	4,477	3,909	4,684	-
	48 96	2	TT	DUTT4896RE	3,336	3,336	3,456	3,907	4,949	4,499	5,276	-
	48 120	2	TT	DUTT48120RE	3,675	3,675	3,829	4,292	5,310	4,985	5,762	-

How to Order

Table Model Number							Options	
DUT	3672	RE	WWSQ	WMW	N/A	MBM	GMBM	E
Base Series	Top Size	Top Shape	Top Material Edge Profile	Top Finish	Edge Finish	Base Finish	Matte Black Grommet	Location "E"
A DUT3672REWWSQWMWMBM is a Dunhill series 36" x 72" rectangle table with two black powder coated T-bases and a wood veneer 1.25" thick top with a 1.25" square wood edge profile.					Edge finish applies when edge material is different from top material.		The code: GMBM specifies a matte black 2" diameter metal grommet.	The code: E specifies the location of the grommet.

Solid Surface

Corian®	
COFL Flat	
COBN Bullnose	
COPR Prism	
-	
-	
-	
-	
-	
-	
-	

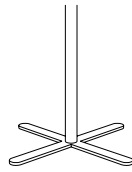

X, XH Base

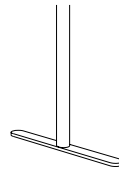

T Base

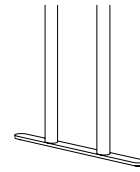

TT Base

Options

Base Finishes

Custom Powder Coat (set-up charge)	CPC	☎
Polished or Satin Chrome (per X base)	use finish code	413
Polished or Satin Chrome (T & TT base, per column)	use finish code	207
Premium Plated (per X base)	use finish code	715
Premium Plated (T & TT base, per column)	use finish code	385
Stainless Steel (per base)	use finish code	1,650

Base Options

Counter, Bar, & Alternate Height (per column)	CH, BH, AH	76
Super Level Glides (per base)	GSL	40
Locking Casters 2" Twin Wheel (qty. 4)	TWC2	65
Tilt-top - (standard cable release)	TMX/TMT	312 X-base/ 483 T-base
Folding	FM	312 T-base

Top Materials and Finishes

Any non-standard WCI Laminates (set-up charge)	use manufacturers finish code	165
Premium Laminates	PL	☎
Custom Wood Veneer	CWV	☎
Stain to Match (set-up charge)	STM	476

Top Options

3" Radius Corner (per corner) (laminates self edge, Ultrafoam, Corian®, 3form® Chroma®)	CRL3	40
3" Wood Radius Corner (per corner) (not available in LWFL and WWFL)	CRW3	95
Custom Radius Corner	CRC	95
Custom Size	CS	☎
Custom Shape	CSH	☎
Custom Edge Thickness	CET	☎
Ganging Clips (1 set includes 2 male and 2 female clips)	GC	171

Grommets

2" Round Metal Grommet - Matte Black	GMBM	160
2" Round Metal Grommet - Satin Chrome	GMSC	160
2" Round Metal Grommet - Polished Chrome	GMPC	160
2" Round Plastic Grommet - Matte Black	GPMBM	51
Grommet location	use location code	n/c

Power, Data, & Wire Management

Wire management	Pages 234-235
Power & data	Pages 236-237

☎ Call for pricing

844.815.2217

FLAT ROUND – Dining & Multipurpose

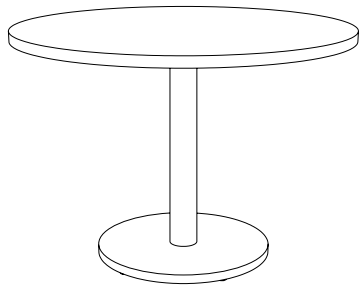

Laminate Surface

Wood Surface

Self Edge	Vinyl Edges	PVC Edges	Wood Edges Group A	Wood Edges Group B	Wood Edges Group A	Wood Edges Group B	Butcher Block
LLSE Self Edge	LVFL Flat	LPVC PVC	LWFL Flat	LWSQ Square	WWFL Flat	WWSQ Square	BBFL Flat
	LVBP Bumper		LWTP Tapered Ply	LWBN Bullnose	WWTP Tapered Ply	WWBN Bullnose	BBBN Bullnose
			LWFP Flat Ply	LWPR Prism	WWFP Flat Ply	WWPR Prism	

Complete Table List Pricing







	Top Size		Base Qty.	Model #								
Round	24		1	FR24RD	960	960	1,040	1,293	1,561	1,308	1,676	1,542
	30		1	FR30RD	1,057	1,057	1,155	1,473	1,760	1,583	1,899	1,934
	36		1	FR36RD	1,398	1,398	1,513	1,888	2,220	1,928	2,387	2,637
	42		1	FR42RD	1,559	1,559	1,687	2,071	2,482	2,220	2,682	3,473
	48		1	FR48RD	1,723	1,723	1,867	2,292	2,764	2,470	3,001	3,911
	54		1	FR54RD	2,078	2,078	2,245	2,815	3,788	3,035	4,129	-
	60		1	FR60RD	2,360	2,360	2,539	3,004	3,919	3,577	4,278	-
Oval	36	72	2	FR3672OV	2,313	2,313	2,395	2,726	3,080	3,001	3,345	-
	42	54	2	FR4254OV	2,277	2,277	2,321	2,647	3,167	2,886	3,263	-
	42	78	2	FR4278OV	3,169	3,169	3,236	3,543	3,893	3,770	4,162	-
	42	84	2	FR4284OV	3,258	3,258	3,345	3,622	4,023	3,856	4,307	-
	48	78	2	FR4878OV	3,671	3,671	3,763	4,030	4,428	4,275	4,719	-
	48	96	2	FR4896OV	3,951	3,951	4,040	4,267	4,699	4,843	5,348	-
RD Square	24	24	1	FR2424RS	963	963	1,051	1,293	1,561	1,308	1,676	1,653
	30	30	1	FR3030RS	1,057	1,057	1,165	1,472	1,760	1,583	1,899	2,081
	36	36	1	FR3636RS	1,398	1,398	1,506	1,870	2,220	1,928	2,387	2,824
	42	42	1	FR4242RS	1,539	1,539	1,660	2,071	2,483	2,220	2,682	3,765
	48	48	1	FR4848RS	1,904	1,904	2,046	2,471	2,943	2,648	3,179	4,433
Square	24	24	1	FR2424SQ	963	963	1,051	1,293	1,561	1,308	1,676	1,653
	30	30	1	FR3030SQ	1,057	1,057	1,165	1,472	1,760	1,583	1,899	2,081
	36	36	1	FR3636SQ	1,398	1,398	1,506	1,870	2,220	1,928	2,387	2,824
	42	42	1	FR4242SQ	1,539	1,539	1,660	2,071	2,483	2,220	2,682	3,765
	48	48	1	FR4848SQ	1,904	1,904	2,046	2,471	2,943	2,648	3,179	4,433

Continued on next page

How to Order

Table Model Number							Options
FR Base Series	36 Top Size	RD Top Shape	WWSQ Top Material Edge Profile	MMW Top Finish	N/A Edge Finish	MBM Base Finish	GSL Super Level Glides
A FR36RDWWSQMMWMBM is a Flat Round series 36" round table with a black powder coat round base and a wood veneer 1.25" thick top with a 1.25" square wood edge profile.					Edge finish applies when edge material is different from top material.		The code: GSL specifies super level glides.

Dining & Multipurpose – FLAT ROUND

Solid Surface	Quartz Surface	
Corian®	Caesarstone® Q1	Okite® Q2
		
COFL Flat	Q1FL Flat	Q2FL Flat
		
COBN Bullnose	Q1BN Bullnose	Q2BN Bullnose
		
COPR Prism		

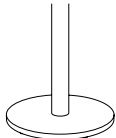

1,796	3,722	5,049
2,230	4,689	7,037
2,996	6,537	8,577
3,620	7,900	10,789
4,326	-	-
5,277	-	-
6,153	-	-
-	-	-
-	-	-
-	-	-
-	-	-
-	-	-
-	-	-
-	-	-
-	-	-
-	-	-
-	-	-
-	-	-
-	-	-
-	-	-
1,662	2,533	4,378
2,061	3,914	6,146
2,809	5,105	7,775
3,396	6,765	9,544
4,260	-	-

Options

Base Finishes		
Custom Powder Coat (set-up charge)	CPC	☎
Polished or Satin Chrome (per base)	use finish code	275
Premium Plated (per base)	use finish code	550
Stainless Steel (per base)	use finish code	1,650

Base Options		
Counter, Bar, & Alternate Height (per column)	CH, BH, AH	76
Super Level Glides (per base)	GSL	40
Custom Top Plate Size	CTPS	☎
6" Column (black texture and powder coat)	COL6	224
6" Column (polished or satin chrome)	COLP6	286
6" Column (premium plated)	COLPP6	☎
6" Column (veneer)	COLV6	446

Top Materials and Finishes		
Any non-standard WCI Laminates (set-up charge)	use manufacturers finish code	165
Premium Laminates	PL	☎
Custom Wood Veneer	CWV	☎
Stain to Match (set-up charge)	STM	476









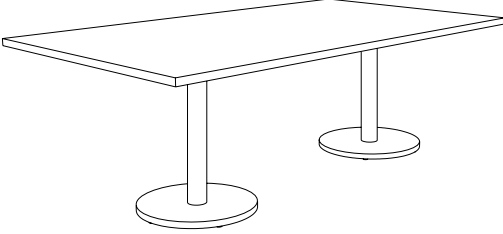









Top Options		
3" Radius Corner (per corner)	CRL3	40
(laminated self edge, Ultrafoam, Corian®, 3form® Chroma®)		
3" Wood Radius Corner (per corner)	CRW3	95
(not available in LWFL and WWFL)		
Custom Size	CS	☎
Custom Radius Corner	CRC	95
Custom Shape	CSH	☎
Custom Edge Thickness	CET	☎

Grommets		
2" Round Metal Grommet - Matte Black	GMBM	160
2" Round Metal Grommet - Satin Chrome	GMSC	160
2" Round Metal Grommet - Polished Chrome	GMPC	160
2" Round Plastic Grommet - Matte Black	GPMBM	51
Grommet location	use location code	n/c

☎ Call for pricing 844.815.2217

FLAT ROUND – Dining & Multipurpose



Laminate Surface				Wood Surface			
Self Edge	Vinyl Edges	PVC Edges	Wood Edges Group A	Wood Edges Group B	Wood Edges Group A	Wood Edges Group B	Butcher Block
 LLSE Self Edge	 LVFL Flat	 LPVC PVC	 LWFL Flat	 LWSQ Square	 WWFL Flat	 WWSQ Square	 BBFL Flat
	 LVBP Bumper		 LWTP Tapered Ply	 LWBN Bullnose	 WWTP Tapered Ply	 WWBN Bullnose	 BBBN Bullnose
			 LWFP Flat Ply	 LWPR Prism	 WWFP Flat Ply	 WWPR Prism	

Complete Table List Pricing

	Top Size	Base Qty.	Model #	1,008	1,053	1,082	1,390	1,686	1,518	1,814	1,839
Rectangle 	24 30	1	FR2430RE	1,008	1,053	1,082	1,390	1,686	1,518	1,814	1,839
	24 36	1	FR2436RE	1,053	1,053	1,136	1,489	1,777	1,594	1,918	2,053
	24 42	1	FR2442RE	1,319	1,319	1,392	1,768	2,087	1,880	2,237	2,574
	24 48	1	FR2448RE	1,376	1,376	1,465	1,883	2,237	2,011	2,405	2,662
	24 60	2	FR2460RE	1,920	1,920	2,016	2,464	2,867	2,605	3,058	3,507
	24 72	2	FR2472RE	2,012	2,012	2,124	2,618	3,079	2,782	3,300	3,905
	24 84	2	FR2484RE	2,357	2,357	2,461	2,749	3,527	2,928	3,804	4,197
	24 96	2	FR2496RE	2,450	2,450	2,564	2,879	3,719	3,073	4,019	4,489
	30 36	1	FR3036RE	1,125	1,125	1,196	1,574	1,889	1,689	2,042	2,325
	30 42	1	FR3042RE	1,396	1,396	1,477	1,938	2,292	2,070	2,468	2,928
	30 48	1	FR3048RE	1,453	1,453	1,543	2,011	2,395	2,155	2,584	3,024
	30 60	2	FR3060RE	2,027	2,027	2,130	2,635	3,073	2,798	3,290	3,945
	30 72	2	FR3072RE	2,136	2,136	2,261	2,754	3,253	2,936	3,491	4,429
	30 84	2	FR3084RE	2,507	2,507	2,611	2,906	3,683	3,103	3,974	4,721
	30 96	2	FR3096RE	2,618	2,618	2,734	3,056	3,958	3,273	4,285	5,013
	36 42	1	FR3642RE	1,471	1,471	1,564	2,027	2,417	2,175	2,607	3,268
	36 48	1	FR3648RE	1,536	1,536	1,634	2,112	2,529	2,267	2,731	3,374
	36 60	2	FR3660RE	2,134	2,134	2,248	2,726	3,198	2,903	3,433	4,371
	36 72	2	FR3672RE	2,264	2,264	2,387	2,930	3,463	3,130	3,732	4,930
	36 84	2	FR3684RE	2,654	2,654	2,765	3,095	3,837	3,319	4,151	5,488
	36 96	2	FR3696RE	2,785	2,785	2,917	3,263	4,115	3,507	4,463	6,037
	42 72	2	FR4272RE	2,826	2,826	2,929	3,461	4,090	3,573	4,237	-
	42 84	2	FR4284RE	3,233	3,233	3,345	3,641	4,452	4,018	4,949	-
	42 96	2	FR4296RE	3,384	3,384	3,505	3,836	4,811	4,243	5,018	-
48 96	2	FR4896RE	3,559	3,559	3,680	4,129	5,171	4,722	5,499	-	
48 120	2	FR48120RE	3,897	3,897	4,052	4,516	5,533	5,209	5,984	-	







How to Order

Table Model Number							Options	
FR Base Series	4896 Top Size	RA Top Shape	WWSQ Top Material Edge Profile	WMW Top Finish	N/A Edge Finish	MBM Base Finish	GMBM Matte Black Grommet	C Location "C"
A FR4896RAWWSQWMWMBM is a Flat Round series 48" x 96" racetrack table with two black powder coat rounds bases and a wood veneer 1.25" thick top with a 1.25" square wood edge profile.						Edge finish applies when edge material is different from top material.	The code: GMBM specifies a matte black 2" diameter metal grommet.	The code: C specifies the location of the grommet.

Dining & Multipurpose – FLAT ROUND

Solid Surface

Quartz Surface

Corian®	Caesarstone® Q1	Okite® Q2
		
COFL Flat	Q1FL Flat	Q2FL Flat
		
COBN Bullnose	Q1BN Bullnose	Q2BN Bullnose
		
COPR Prism		

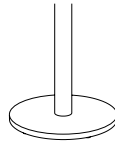

Options

Base Finishes

Custom Powder Coat (set-up charge)	CPC	☎
Polished or Satin Chrome (per base)	use finish code	275
Premium Plated (per base)	use finish code	550
Stainless Steel (per base)	use finish code	1,650

Base Options

Counter, Bar, & Alternate Height (per column)	CH, BH, AH	76
Super Level Glides (per base)	GSL	40
Custom Top Plate Size	CTPS	☎
6" Column (black texture and powder coat)	COL6	224
6" Column (polished or satin chrome)	COLP6	286
6" Column (premium plated)	COLPP6	☎
6" Column (veneer)	COLV6	446

Top Materials and Finishes

Any non-standard WCI Laminates (set-up charge)	use manufacturers finish code	165
Premium Laminates	PL	☎
Custom Wood Veneer	CWV	☎
Stain to Match (set-up charge)	STM	476

Top Options

3" Radius Corner (per corner) (laminated self edge, Ultrafoam, Corian®, 3form® Chroma®)	CRL3	40
3" Wood Radius Corner (per corner) (not available in LWFL and WWFL)	CRW3	95
Custom Size	CS	☎
Custom Radius Corner	CRC	95
Custom Shape	CSH	☎
Custom Edge Thickness	CET	☎

Grommets

2" Round Metal Grommet - Matte Black	GMBM	160
2" Round Metal Grommet - Satin Chrome	GMSC	160
2" Round Metal Grommet - Polished Chrome	GMPC	160
2" Round Plastic Grommet - Matte Black	GPMBM	51
Grommet location	use location code	n/c

1,846	2,514	4,908
2,026	2,779	5,440
2,417	3,364	6,006
2,597	-	-
3,434	-	-
3,814	-	-
-	-	-
-	-	-
2,286	3,453	6,323
2,719	3,912	6,714
2,961	-	-
3,862	-	-
4,319	-	-
-	-	-
-	-	-
3,324	4,604	7,882
3,846	-	-
4,327	-	-
4,849	-	-
-	-	-
-	-	-
-	-	-
-	-	-
-	-	-
-	-	-
-	-	-
-	-	-
-	-	-

☎ Call for pricing

844.815.2217

KONE – Dining & Multipurpose

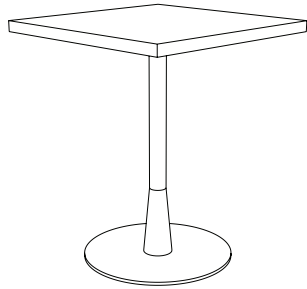

Laminate Surface			Wood Surface			
Self Edge	PVC Edges	Wood Edges Group A	Wood Edges Group A	Wood Edges Group B	Butcher Block	
LLSE Self Edge	LPVC PVC	LWFL Flat	WWFL Flat	WWSQ Square	BBFL Flat	
LFSE Facet Self Edge		LWTP Tapered Ply	WWTP Tapered Ply	WWBN Bullnose	BBBN Bullnose	
		LWFP Flat Ply	WWFP Flat Ply	WWPR Prism		
			WWFC Facet	WWFC Facet		

Complete Table List Pricing

	Top Size		Base Qty.	Model #						
Round 	24		1	KO24RD	1,621	1,697	1,943	1,959	2,318	2,186
	30		1	KO30RD	1,714	1,810	2,119	2,229	2,534	2,569
	36		1	KO36RD	2,091	2,203	2,567	2,607	3,056	3,299
	42		1	KO42RD	2,248	2,372	2,747	2,893	3,344	4,113
	48		1	KO48RD	2,872	3,012	3,428	3,599	4,118	5,005
Oval 	36	72	2	KO3672OV	3,622	3,702	4,025	4,292	4,629	-
Square 	24	24	1	KO2424SQ	1,621	1,707	1,943	1,959	2,318	2,296
	30	30	1	KO3030SQ	1,714	1,819	2,119	2,229	2,534	2,714
	36	36	1	KO3636SQ	2,091	2,197	2,552	2,607	3,056	3,480
Rectangle 	24	30	1	KO2430RE	1,665	1,738	2,038	2,164	2,451	2,477
	24	36	1	KO2436RE	1,962	2,045	2,388	2,490	2,806	2,938
	24	42	1	KO2442RE	2,014	2,085	2,453	2,561	2,910	3,240
	24	48	1	KO2448RE	2,068	2,156	2,563	2,688	3,071	3,324
	24	60	2	KO2460RE	3,240	3,333	3,769	3,906	4,348	4,785
	24	72	2	KO2472RE	3,329	3,438	3,919	4,079	4,585	5,174

Continued on next page

How to Order







Table Model Number							Options	
KO	36	RD	WWFC	WMW	N/A	MBM	WMW	AH
Base Series	Top Size	Top Shape	Top Material Edge Profile	Top Finish	Edge Finish	Base Finish	Wood Column Finish	Alternate Height Base

A KO36RDWWFCWMWMBMWMW is a Kone series 36" round table with a black powder coat round base and a wood veneer 1.25" thick top with a 1.25" facet wood edge profile.

Edge finish applies when edge material is different from top material.

The code: AH specifies alternate height base.

Solid Surface Quartz

Corian®	Caesarstone® Q1	Okite® Q2
		
COFL Flat	Q1FL Flat	Q2FL Flat
		
COBN Bullnose	Q1BN Bullnose	Q2BN Bullnose
		
COPR Prism		

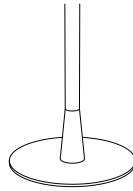

Options

Base Finishes

Custom Powder Coat (set-up charge)	CPC	660
Polished or Satin Chrome (per base)	use finish code	1,430
Premium Plated (per base)	use finish code	1,650
Stainless Steel (per base)	use finish code	1,650

Base Options

Alternate Height Base (per column)(29.25 or lower)	AH	76
Nylon Octagon Glides (per base)	GNO	40
Custom Top Plate Size	CTPS	
Base sizes may vary with quartz tops		

Top Materials and Finishes

Any non-standard WCI Laminates (set-up charge)	use manufacturers finish code	165
Premium Laminates	PL	
Custom Wood Veneer	CWV	
Stain to Match (set-up charge)	STM	476

Top Options

3" Radius Corner (per corner) (laminate self edge, Ultrafoam, Corian®, 3form® Chroma®)	CRL3	40
3" Wood Radius Corner (per corner) (not available in LWFL and WWFL)	CRW3	95
Custom Radius Corner	CRC	95
Custom Size	CS	
Custom Shape	CSH	
Custom Edge Thickness	CET	

2,435	4,315	5,606
3,650	5,256	7,546
3,650	7,103	9,093
4,258	8,433	11,249
5,412	-	-
-	-	-

2,303	3,154	4,952
2,694	4,752	6,930
3,467	5,707	8,309

2,483	3,134	5,470
2,912	3,645	6,239
3,083	4,007	6,586
3,260	-	-
4,715	-	-
5,086	-	-

Call for pricing

844.815.2217

KONE – Dining & Multipurpose

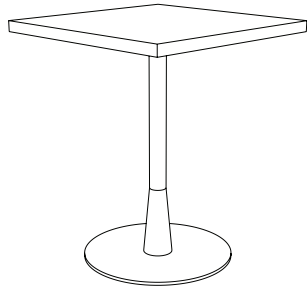

Laminate Surface			Wood Surface			
Self Edge	PVC Edges	Wood Edges Group A	Wood Edges Group A	Wood Edges Group B	Butcher Block	
LLSE Self Edge	LPVC PVC	LWFL Flat	WWFL Flat	WWSQ Square	BBFL Flat	
LFSE Facet Self Edge		LWTP Tapered Ply	WWTP Tapered Ply	WWBN Bullnose	BBBN Bullnose	
		LWFP Flat Ply	WWFP Flat Ply	WWPR Prism		
			WWFC Facet	WWFC Facet		







Complete Table List Pricing

	Top Size		Base Qty.	Model #						
Rectangle 	30	36	1	KO3036RE	2,034	2,103	2,471	2,583	2,928	3,202
	30	42	1	KO3042RE	2,088	2,169	2,619	2,746	3,135	3,583
	30	48	1	KO3048RE	2,609	2,697	3,154	3,293	3,711	4,140
	30	60	2	KO3060RE	3,345	3,444	3,935	4,094	4,575	5,213
	30	72	2	KO3072RE	3,451	3,571	4,052	4,230	4,772	5,685
	36	42	1	KO3642RE	2,160	2,253	2,705	2,849	3,269	3,915
	36	48	1	KO3648RE	2,688	2,785	3,252	3,403	3,856	4,483
	36	60	2	KO3660RE	3,952	4,065	4,530	4,704	5,221	6,134
	36	72	2	KO3672RE	4,080	4,200	4,730	4,924	5,511	6,680

How to Order

Table Model Number								Options
KO Base Series	36 Top Size	RD Top Shape	WWFC Top Material Edge Profile	WMW Top Finish	N/A Edge Finish	MBM Base Finish	WMW Wood Column Finish	AH Alternate Height Base
A KO36RDWWFCWMWMBMWMW is a Kone series 36" round table with a black powder coat round base and a wood veneer 1.25" thick top with a 1.25" facet wood edge profile.					Edge finish applies when edge material is different from top material.			The code: AH specifies alternate height base.

Solid Surface Quartz

Corian®	Caesarstone® Q1	Okite® Q2
		
COFL Flat	Q1FL Flat	Q2FL Flat
		
COBN Bullnose	Q1BN Bullnose	Q2BN Bullnose
		
COPR Prism		

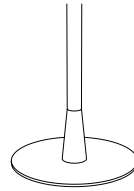

Options

Base Finishes

Custom Powder Coat (set-up charge)	CPC	660
Polished or Satin Chrome (per base)	use finish code	1,430
Premium Plated (per base)	use finish code	1,650
Stainless Steel (per base)	use finish code	1,650

Base Options

Alternate Height Base (per column)(29.25 or lower)	AH	76
Nylon Octagon Glides (per base)	GNO	40
Custom Top Plate Size	CTPS	Call for pricing
Base sizes may vary with quartz tops		

Top Materials and Finishes

Any non-standard WCI Laminates (set-up charge)	use manufacturers finish code	165
Premium Laminates	PL	Call for pricing
Custom Wood Veneer	CWV	Call for pricing
Stain to Match (set-up charge)	STM	476

Top Options





3" Radius Corner (per corner) (laminate self edge, Ultrafoam, Corian®, 3form® Chroma®)	CRL3	40
3" Wood Radius Corner (per corner) (not available in LWFL and WWFL)	CRW3	95
Custom Radius Corner	CRC	95
Custom Size	CS	Call for pricing
Custom Shape	CSH	Call for pricing
Custom Edge Thickness	CET	Call for pricing

3,164	4,303	7,103
3,379	4,542	7,274
4,079	-	-
5,134	-	-
5,578	-	-
3,969	5,680	8,878
4,942	-	-
6,093	-	-
6,600	-	-

Call for pricing

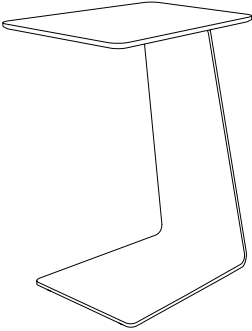
844.815.2217

MOVE – Multipurpose

	Laminate Surface		Solid Surface
	Laminate	Veneer	Corian®
	 LMOV Ply	 WMOV Wood	

Complete Table List Pricing

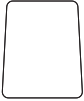
	Top Size		Table Height		Model #	1,096	1,210	1,242
	18	13	15	25				
Trapezoid					MOV			
								

How to Order

Table Model Number

MOV Table Series	WMOV Top Material	WNM Top Finish	MBM Base Finish
----------------------------	-----------------------------	--------------------------	---------------------------

A MOVWMOVWNMBM is a Move table with a matte black powder coat base and a wood veneer top.

The code: WNM specifies a natural maple top.

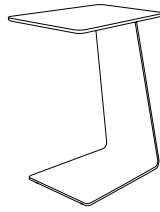

Options

Base Finishes

Custom Powder Coat (set-up charge)	CPC	📞
Satin Chrome (per base)	use finish code	523
Premium Plated (per base)*	use finish code	1,430

*Premium plated polished not available on Move tables.

Top Materials and Finishes

Any non-standard WCI Laminates (set-up charge)	use manufacturers finish code	165
Premium Laminates	PL	📞
Custom Wood Veneer	CWV	📞
Stain to Match (set-up charge)	STM	476

Top Options

Handle**	HAN	99
Cup holder Left	CHL	99
Cup Holder Right	CHR	99
Bag Hook Left	BHL	72
Bag Hook Right	BHR	72

**Handle available for Corian®.



📞 Call for pricing

844.815.2217

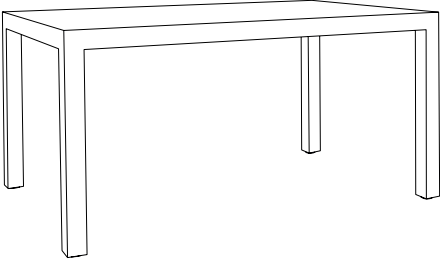
PARSONS – Dining & Multipurpose

	Laminate	Wood
	Laminate LAM Laminate	Veneer VEN Wood Veneer

Complete Table List Pricing

	Top Size	Base Qty.	Model #		
Square 	36 36	1	PA3636SQ	2,841	3,868
	42 42	1	PA4242SQ	3,147	4,316
	48 48	1	PA4848SQ	3,469	4,941
Rectangle 	24 60	1	PA2460RE	2,973	4,083
	24 72	1	PA2472RE	3,219	4,382
	24 84	1	PA2484RE	3,754	5,112
	24 96	1	PA2496RE	4,292	5,842
	24 120	1	PA24120RE	5,365	7,303
	30 60	1	PA3060RE	3,187	4,362
	30 72	1	PA3072RE	3,475	4,832
	30 84	1	PA3084RE	4,055	5,636
	30 96	1	PA3096RE	4,633	6,443
	30 120	1	PA30120RE	5,792	8,053
	36 60	1	PA3660RE	3,422	4,775
	36 72	1	PA3672RE	3,738	5,190
	36 84	1	PA3684RE	4,360	6,054
	36 96	1	PA3696RE	4,984	6,920
	36 120	1	PA36120RE	6,230	8,650
	42 60	1	PA4260RE	3,992	5,572
	42 72	1	PA4272RE	4,791	6,686
	42 84	1	PA4284RE	5,589	7,800
	42 96	1	PA4296RE	6,387	8,914
	42 120	1	PA42120RE	7,985	11,143

How to Order

Table Model Number					Options
PA Base Series	3636 Top Size	SQ Top Shape	VEN Material	WNW Top, edge and leg finish	PAH1 Alternate Height Base - Below 29"
A PA3636SQVENWNW is a Parsons series 36" x 36" square table with wood veneer top, edge and legs.				The code: WNW specifies a natural walnut top.	The code: PAH1 specifies alternate height base below 29".

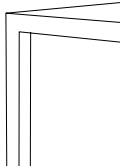

Options

Base Options		
Counter Height	CH	pages 102-103
Bar Height	BH	pages 102-103
Alternate Height	AH	1,040

Top Materials and Finishes		
Any non-standard WCI Laminates (set-up charge)	use manufacturers finish code	165
Premium Laminates	PL	📞
Custom Wood Veneer	CWV	📞
Stain to Match (set-up charge)	STM	476

Top Options		
Custom Size	CS	📞
Custom Shape	CSH	📞



📞 Call for pricing

844.815.2217

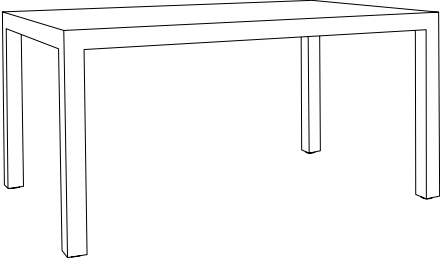
PARSONS – Counter & Bar Height - Dining & Multipurpose

	Laminate	Wood
	Laminate LAM Laminate	Veneer VEN Wood Veneer

Complete Table List Pricing

	Top Size	Base Qty.	Model #		
Square 	36 36	1	PA3636SQ	3,630	4,629
	42 42	1	PA4242SQ	3,928	5,066
	48 48	1	PA4848SQ	4,242	5,675
Rectangle 	24 60	1	PA2460RE	3,758	4,839
	24 72	1	PA2472RE	3,996	5,130
	24 84	1	PA2484RE	4,519	5,841
	24 96	1	PA2496RE	5,042	6,552
	24 120	1	PA24120RE	6,087	7,975
	30 60	1	PA3060RE	3,966	5,111
	30 72	1	PA3072RE	4,247	5,568
	30 84	1	PA3084RE	4,811	6,353
	30 96	1	PA3096RE	5,376	7,137
	30 120	1	PA30120RE	6,502	8,705
	36 60	1	PA3660RE	4,195	5,513
	36 72	1	PA3672RE	4,503	5,917
	36 84	1	PA3684RE	5,110	6,758
	36 96	1	PA3696RE	5,717	7,601
	36 120	1	PA36120RE	6,930	9,287
	42 60	1	PA4260RE	4,751	6,288
	42 72	1	PA4272RE	5,528	7,373
	42 84	1	PA4284RE	6,305	8,459
	42 96	1	PA4296RE	7,083	9,545
	42 120	1	PA42120RE	8,638	11,715

How to Order

Table Model Number					Options
PA Base Series	3636 Top Size	SQ Top Shape	VEN Material	WNW Top, edge and leg finish	PAH1 Alternate Height Base - Below 29"
A PA3636SQVENWNW is a Parsons series 36" x 36" square table with wood veneer top, edge and legs.				The code: WNW specifies a natural walnut top.	The code: PAH1 specifies alternate height base below 29".

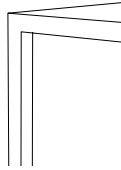

Options

Top Materials and Finishes

Any non-standard WCI Laminates (set-up charge)	use manufacturers finish code	165
Premium Laminates	PL	📞
Custom Wood Veneer	CWV	📞
Stain to Match (set-up charge)	STM	476

Top Options

Custom Size	CS	📞
Custom Shape	CSH	📞

📞 Call for pricing

844.815.2217

PLATFORM – Dining & Multipurpose

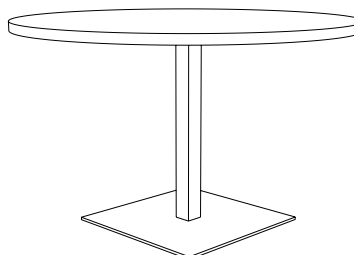

Laminate Surface						Wood Surface					
Self Edge	Vinyl Edges	PVC Edges	Wood Edges Group A	Wood Edges Group B	Wood Edges Group A	Wood Edges Group B	Butcher Block				
LLSE Self Edge	LVFL Flat LVBP Bumper	LPVC PVC	LWFL Flat LWTP Tapered Ply LWFP Flat Ply	LWSQ Square LWBN Bullnose LWPR Prism	WWFL Flat WWTP Tapered Ply WWFP Flat Ply	WWSQ Square WWBN Bullnose WWPR Prism	BBFL Flat BBBN Bullnose				

Complete Table List Pricing







	Top Size	Base Qty.	Model #								
Round	30	1	PL30RD	1,173	1,173	1,271	1,587	1,874	1,697	2,014	2,049
	36	1	PL36RD	1,585	1,585	1,701	2,075	2,407	2,115	2,574	2,824
	48	1	PL48RD	2,133	2,133	2,277	2,702	3,174	2,879	3,410	4,320
	54	1	PL54RD	2,310	2,310	2,477	3,046	4,021	3,266	4,360	-
	60	1	PL60RD	2,591	2,591	2,771	3,236	4,150	3,809	4,510	-
RD Square	24 24	1	PL2424RS	1,077	1,077	1,165	1,407	1,676	1,423	1,791	1,769
	30 30	1	PL3030RS	1,173	1,173	1,279	1,587	1,874	1,697	2,014	2,197
	36 36	1	PL3636RS	1,585	1,585	1,693	2,057	2,407	2,115	2,574	3,011
	42 42	1	PL4242RS	1,726	1,726	1,848	2,258	2,670	2,407	2,869	3,953
	48 48	1	PL4848RS	2,135	2,135	2,277	2,703	3,174	2,880	3,411	4,664
Square	24 24	1	PL2424SQ	1,077	1,077	1,165	1,407	1,676	1,423	1,791	1,769
	30 30	1	PL3030SQ	1,173	1,173	1,279	1,587	1,874	1,697	2,014	2,197
	36 36	1	PL3636SQ	1,585	1,585	1,693	2,057	2,407	2,115	2,574	3,011
	42 42	1	PL4242SQ	1,726	1,726	1,848	2,258	2,670	2,407	2,869	3,953
	48 48	1	PL4848SQ	2,135	2,135	2,277	2,703	3,174	2,880	3,411	4,664
Rectangle	24 30	1	PL2430RE	1,123	1,123	1,198	1,505	1,801	1,632	1,928	1,955
	24 36	1	PL2436RE	1,454	1,454	1,538	1,890	2,178	1,995	2,320	2,454
	24 42	1	PL2442RE	1,506	1,506	1,579	1,956	2,274	2,067	2,424	2,761
	24 48	1	PL2448RE	1,563	1,563	1,652	2,070	2,424	2,198	2,592	2,849
	24 60	2	PL2460RE	2,151	2,151	2,246	2,694	3,097	2,835	3,288	3,737
	24 72	2	PL2472RE	2,242	2,242	2,354	2,849	3,309	3,012	3,530	4,135
	24 84	2	PL2484RE	2,588	2,588	2,692	2,979	3,757	3,159	4,035	4,428
	24 96	2	PL2496RE	2,680	2,680	2,795	3,110	3,949	3,303	4,250	4,719

Continued on next page

How to Order

Table Model Number							Options
PL Base Series	36 Top Size	RD Top Shape	WWSQ Top Material Edge Profile	WMW Top Finish	N/A Edge Finish	MBM Base Finish	AH Alternate Height Base
A PL36RDWWSQWMWMBM is a Platform series 36" round table with a black powder coat square base and a wood veneer 1.25" thick top with a 1.25" square wood edge profile.						Edge finish applies when edge material is different from top material.	The code: AH specifies alternate height base.

Solid Surface Quartz Surface

Corian®	Caesarstone® Q1	Okite® Q2
		
COFL Flat	Q1FL Flat	Q2FL Flat
		
COBN Bullnose	Q1BN Bullnose	Q2BN Bullnose
		
COPR Prism		

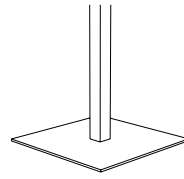

Single Column Base

Options

Base Finishes

Custom Powder Coat (set-up charge)	CPC	660
Polished or Satin Chrome (per base)	use finish code	1,430
Premium Plated (per base)	use finish code	1,650
Stainless Steel (per base)	use finish code	1,650

Base Options

Counter, Bar, & Alternate Height (per column)	CH, BH, AH	76
Nylon Octagon Glides (per base)	GNO	40
Custom Top Plate Size	CTPS	660
6" Column (black texture and powder coat)	COL6	224
6" Column (polished or satin chrome)	COLP6	286
6" Column (premium plated)	COLPP6	660
6" Column (veneer)	COLV6	446
Base sizes may vary with quartz tops		

Top Materials and Finishes

Any non-standard WCI Laminates (set-up charge)	use manufacturers finish code	165
Premium Laminates	PL	660
Custom Wood Veneer	CWV	660
Stain to Match (set-up charge)	STM	476

Top Options

3" Radius Corner (per corner) (laminate self edge, Ultrafoam, Corian®, 3form® Chroma®)	CRL3	40
3" Wood Radius Corner (per corner) (not available in LWFL and WWFL)	CRW3	95
Custom Size	CS	660
Custom Radius Corner	CRC	95
Custom Shape	CSH	660
Custom Edge Thickness	CET	660

Grommets



















2" Round Metal Grommet - Matte Black	GMBM	160
2" Round Metal Grommet - Satin Chrome	GMSC	160
2" Round Metal Grommet - Polished Chrome	GMPC	160
2" Round Plastic Grommet - Matte Black	GPMBM	51
Grommet location	use location code	n/c

2,345	-	-
3,185	-	-
4,737	-	-
5,508	-	-
6,384	-	-
-	-	-
-	-	-
-	-	-
-	-	-
-	-	-
1,778	2,649	4,494
2,177	4,028	6,261
2,996	5,292	7,963
3,583	6,952	9,731
4,491	-	-
1,961	2,629	5,023
2,427	3,179	5,840
2,604	3,551	6,193
2,784	-	-
3,665	-	-
4,045	-	-
-	-	-
-	-	-

Call for pricing

844.815.2217

PLATFORM – Dining & Multipurpose

Laminate Surface						Wood Surface					
Self Edge	Vinyl Edges	PVC Edges	Wood Edges Group A	Wood Edges Group B	Wood Edges Group A	Wood Edges Group B	Butcher Block				
 LLSE Self Edge	 LVFL Flat	 LPVC PVC	 LWFL Flat	 LWSQ Square	 WWFL Flat	 WWSQ Square	 BBFL Flat				
	 LVBP Bumper		 LWTP Tapered Ply	 LWBN Bullnose	 WWTP Tapered Ply	 WWBN Bullnose	 BBBN Bullnose				
			 LWFP Flat Ply	 LWPR Prism	 WWFP Flat Ply	 WWPR Prism					

Complete Table List Pricing







	Top Size	Base Qty.	Model #								
Rectangle	30 36	1	PL3036RE	1,526	1,526	1,597	1,976	2,290	2,090	2,443	2,726
	30 42	1	PL3042RE	1,583	1,583	1,665	2,125	2,479	2,257	2,655	3,115
	30 48	1	PL3048RE	1,863	1,863	1,953	2,420	2,804	2,565	2,994	3,433
	30 60	2	PL3060RE	2,258	2,258	2,360	2,864	3,303	3,028	3,520	4,175
	30 72	2	PL3072RE	2,367	2,367	2,490	2,984	3,484	3,166	3,721	4,660
	30 84	2	PL3084RE	2,737	2,737	2,841	3,136	3,913	3,333	4,204	4,951
	30 96	2	PL3096RE	2,849	2,849	2,963	3,287	4,188	3,504	4,514	5,243
	36 42	1	PL3642RE	1,658	1,658	1,751	2,214	2,604	2,362	2,794	3,456
	36 48	1	PL3648RE	1,946	1,946	2,044	2,522	2,939	2,676	3,142	3,783
	36 60	2	PL3660RE	2,936	2,936	3,050	3,528	4,000	3,705	4,235	5,173
	36 72	2	PL3672RE	3,067	3,067	3,190	3,732	4,265	3,931	4,534	5,733
	36 84	2	PL3684RE	3,456	3,456	3,567	3,898	4,639	4,121	4,953	6,290
	36 96	2	PL3696RE	3,587	3,587	3,719	4,066	4,917	4,309	5,265	6,839
	42 72	2	PL4272RE	3,647	3,647	3,750	4,281	4,910	4,392	5,058	-
42 84	2	PL4284RE	4,052	4,052	4,165	4,461	5,271	4,838	5,768	-	
42 96	2	PL4296RE	4,203	4,203	4,325	4,655	5,631	5,063	5,838	-	
48 96	2	PL4896RE	4,379	4,379	4,499	4,950	5,991	5,542	6,318	-	
48 120	2	PL48120RE	4,717	4,717	4,872	5,335	6,353	6,028	6,805	-	

How to Order

Table Model Number							Options	
PL Base Series	3636 Top Size	SQ Top Shape	WWSQ Top Material Edge Profile	WMW Top Finish	N/A Edge Finish	MBM Base Finish	GMBM Matte Black Grommet	E Location "E"
A PL3636SQWWSQWMWMBM is a Platform series 36" x 36" square table with a black powder coat square base and a wood veneer 1.25" thick top with a 1.25" square wood edge profile.						Edge finish applies when edge material is different from top material.	The code: GMBM specifies a matte black 2" diameter metal grommet.	The code: E specifies the location of the grommet.

Solid Surface

Quartz Surface

Corian®	Caesarstone® Q1	Okite® Q2
		
COFL Flat	Q1FL Flat	Q2FL Flat
		
COBN Bullnose	Q1BN Bullnose	Q2BN Bullnose
		
COPR Prism		

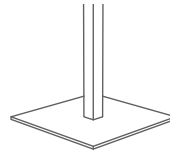

Single Column Base

Options

Base Finishes

Custom Powder Coat (set-up charge)	CPC	660
Polished or Satin Chrome (per base)	use finish code	1,430
Premium Plated (per base)	use finish code	1,650
Stainless Steel (per base)	use finish code	1,650

Base Options

Counter, Bar, & Alternate Height (per column)	CH, BH, AH	76
Nylon Octagon Glides (per base)	GNO	40
Custom Top Plate Size	CTPS	660
6" Column (black texture and powder coat)	COL6	224
6" Column (polished or satin chrome)	COLP6	286
6" Column (premium plated)	COLPP6	660
6" Column (veneer)	COLV6	446
Base sizes may vary with quartz tops		

Top Materials and Finishes

Any non-standard WCI Laminates (set-up charge)	use manufacturers finish code	165
Premium Laminates	PL	660
Custom Wood Veneer	CWV	660
Stain to Match (set-up charge)	STM	476

Top Options

3" Radius Corner (per corner) (laminate self edge, Ultrafoam, Corian®, 3form® Chroma®)	CRL3	40
3" Wood Radius Corner (per corner) (not available in LWFL and WWFL)	CRW3	95
Custom Size	CS	660
Custom Radius Corner	CRC	95
Custom Shape	CSH	660
Custom Edge Thickness	CET	660

Grommets

2" Round Metal Grommet - Matte Black	GMBM	160
2" Round Metal Grommet - Satin Chrome	GMSC	160
2" Round Metal Grommet - Polished Chrome	GMPC	160
2" Round Plastic Grommet - Matte Black	GPMBM	51
Grommet location	use location code	n/c

2,686	3,853	6,724	
2,906	4,099	6,901	
3,370	-	-	
4,093	-	-	
4,549	-	-	
-	-	-	
-	-	-	
3,511	4,791	8,069	
4,255	-	-	
5,129	-	-	
5,651	-	-	
-	-	-	
-	-	-	
-	-	-	
-	-	-	
-	-	-	
-	-	-	
-	-	-	

Call for pricing

844.815.2217

PLATFORM DOUBLE – Dining & Multipurpose

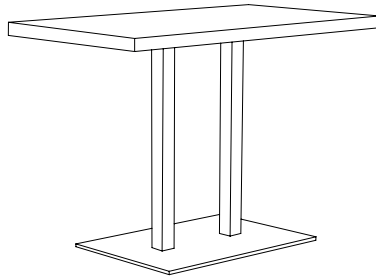

Laminate Surface

Wood Surface

Self Edge	Vinyl Edges	PVC Edges	Wood Edges Group A	Wood Edges Group B	Wood Edges Group A	Wood Edges Group B	Butcher Block
LSE Self Edge	LVFL Flat	LPVC PVC	LWFL Flat	LWSQ Square	WWFL Flat	WWSQ Square	BBFL Flat
	LVBP Bumper		LWTP Tapered Ply	LWBN Bullnose	WWTP Tapered Ply	WWBN Bullnose	BBBN Bullnose
			LWFP Flat Ply	LWPR Prism	WWFP Flat Ply	WWPR Prism	

Complete Table List Pricing

	Top Size		Base Qty.	Model #								
Rectangle	24	42	1	PLD2442RE	1,849	1,849	1,922	2,298	2,617	2,410	2,768	3,104
	24	48	1	PLD2448RE	1,905	1,905	1,995	2,413	2,768	2,540	2,935	3,192
	30	42	1	PLD3042RE	1,925	1,925	2,008	2,468	2,823	2,599	2,999	3,458
	30	48	1	PLD3048RE	1,983	1,983	2,074	2,540	2,925	2,684	3,114	3,553
	36	42	1	PLD3642RE	2,001	2,001	2,094	2,558	2,947	2,705	3,137	3,798
	36	48	1	PLD3648RE	2,066	2,066	2,164	2,642	3,059	2,797	3,262	3,904

How to Order

Table Model Number

PLD Base Series	4272 Top Size	RE Top Shape	WWSQ Top Material Edge Profile	WMW Top Finish	N/A Edge Finish	MBM Base Finish
---------------------------	-------------------------	------------------------	---	--------------------------	---------------------------	---------------------------

Options

GMBM Matte Black Grommet	E Location "E"
---------------------------------------	--------------------------

A PLD3648REWWSQWMWMBM is a Platform Double series 36" x 48" rectangle table with a black powder coat square base and a wood veneer 1.25" thick top with a 1.25" square wood edge profile.

Edge finish applies when edge material is different from top material.







The code: GMBM specifies a matte black 2" diameter metal grommet.

The code: E specifies the location of the grommet.

Dining & Multipurpose – PLATFORM DOUBLE

Solid Surface

Quartz Surface

Corian®	Caesarstone® Q1	Okite® Q2
		
COFL Flat	Q1FL Flat	Q2FL Flat
		
COBN Bullnose	Q1BN Bullnose	Q2BN Bullnose
		
COPR Prism		

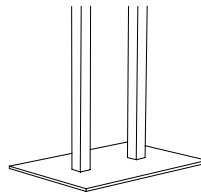

Double Column Base

Options

Base Finishes

Custom Powder Coat (set-up charge)	CPC	📞
Polished or Satin Chrome (per base)	use finish code	770
Premium Plated (per base)	use finish code	1,540
Stainless Steel (per base)	use finish code	1,650

Base Options

Counter, Bar, & Alternate Height (per column)	CH, BH, AH	76
Nylon Octagon Glides (per base)	GNO	40
Custom Top Plate Size	CTPS	📞
6" Column (black texture and powder coat)	COL6	224
6" Column (polished or satin chrome)	COLP6	286
6" Column (premium plated)	COLPP6	📞
6" Column (veneer)	COLV6	446
Base sizes may vary with quartz tops		

Top Materials and Finishes

Any non-standard WCI Laminates (set-up charge)	use manufacturers finish code	165
Premium Laminates	PL	📞
Custom Wood Veneer	CWV	📞
Stain to Match (set-up charge)	STM	476

Top Options

3" Radius Corner (per corner) (laminate self edge, Ultrafoam, Corian®, 3form® Chroma®)	CRL3	40
3" Wood Radius Corner (per corner) (not available in LWFL and WWFL)	CRW3	95
Custom Size	CS	📞
Custom Radius Corner	CRC	95
Custom Shape	CSH	📞
Custom Edge Thickness	CET	📞

Grommets











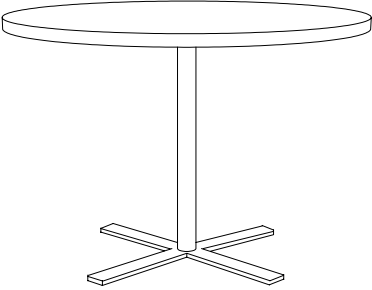







2" Round Metal Grommet - Matte Black	GMBM	160
2" Round Metal Grommet - Satin Chrome	GMSC	160
2" Round Metal Grommet - Polished Chrome	GMPC	160
2" Round Plastic Grommet - Matte Black	GPMBM	51
Grommet location	use location code	n/c

2,947	3,894	6,536
3,127	-	-
3,248	4,442	7,245
3,491	-	-
3,853	5,134	8,412
4,375	-	-





📞 Call for pricing

844.815.2217

PLUS – Dining & Multipurpose

	Laminate Surface					Wood Surface						
	Self Edge	Vinyl Edges	PVC Edges	Wood Edges Group A	Wood Edges Group B	Wood Edges Group A	Wood Edges Group B	Butcher Block				
	 LLSE Self Edge	 LVFL Flat	 LPVC PVC	 LWFL Flat	 LWSQ Square	 WWFL Flat	 WWSQ Square	 BBFL Flat				
		 LVBP Bumper		 LWTP Tapered Ply	 LWBN Bullnose	 WWTP Tapered Ply	 WWBN Bullnose	 BBBN Bullnose				
				 LWFP Flat Ply	 LWPR Prism	 WWFP Flat Ply	 WWPR Prism					

Complete Table List Pricing

	Top Size		Base Qty.	Base Style	Model #								
Round 	24		1	X	PUX24RD	1,139	1,139	1,218	1,471	1,739	1,486	1,855	1,720
	30		1	X	PUX30RD	1,356	1,356	1,453	1,771	2,058	1,881	2,198	2,233
	36		1	X	PUX36RD	1,601	1,601	1,715	2,090	2,422	2,131	2,589	2,839
	42		1	X	PUX42RD	1,761	1,761	1,890	2,274	2,684	2,422	2,884	3,675
	48		1	X	PUX48RD	2,044	2,044	2,189	2,614	3,086	2,791	3,322	4,232
	54		1	XH	PUXH54RD	2,335	2,335	2,503	3,071	4,046	3,291	4,386	-
	60		1	XH	PUXH60RD	2,616	2,616	2,796	3,262	4,176	3,835	4,535	-
Oval 	36	72	2	T	PUT3672OV	2,206	2,206	2,286	2,617	2,971	2,892	3,236	-
	42	54	2	T	PUT4254OV	2,168	2,168	2,212	2,538	3,058	2,778	3,155	-
	42	78	2	T	PUT4278OV	2,633	2,633	2,699	3,007	3,357	3,234	3,626	-
	42	84	2	T	PUT4284OV	2,723	2,723	2,808	3,087	3,486	3,319	3,771	-
	48	78	2	TT	PUTT4878OV	2,980	2,980	3,072	3,340	3,737	3,584	4,028	-
	48	96	2	TT	PUTT4896OV	3,260	3,260	3,350	3,576	4,008	4,153	4,657	-
RD Square 	24	24	1	X	PUX2424RS	1,141	1,141	1,229	1,471	1,740	1,486	1,855	1,832
	30	30	1	X	PUX3030RS	1,355	1,355	1,463	1,771	2,058	1,881	2,197	2,380
	36	36	1	X	PUX3636RS	1,601	1,601	1,708	2,072	2,422	2,131	2,589	3,026
	42	42	1	X	PUX4242RS	1,860	1,860	1,982	2,393	2,804	2,541	3,003	4,088
	48	48	1	X	PUX4848RS	2,047	2,047	2,189	2,614	3,086	2,791	3,322	4,576
Square 	24	24	1	X	PUX2424SQ	1,141	1,141	1,229	1,471	1,740	1,486	1,855	1,832
	30	30	1	X	PUX3030SQ	1,355	1,355	1,463	1,771	2,058	1,881	2,197	2,380
	36	36	1	X	PUX3636SQ	1,601	1,601	1,708	2,072	2,422	2,131	2,589	3,026
	42	42	1	X	PUX4242SQ	1,860	1,860	1,982	2,393	2,804	2,541	3,003	4,088
	48	48	1	X	PUX4848SQ	2,047	2,047	2,189	2,614	3,086	2,791	3,322	4,576

Continued on next page

How to Order

Table Model Number							Options
PUX Base Series	36 Top Size	RD Top Shape	WWSQ Top Material Edge Profile	WMW Top Finish	N/A Edge Finish	MBM Base Finish	AH Alternate Height Base
A PUX36RDWWSQWMWMBM is a Plus series 36" round table with a black powder coat X-base and a wood veneer 1.25" thick top with a 1.25" square wood edge profile.						Edge finish applies when edge material is different from top material.	The code: AH specifies alternate height base.

Solid Surface

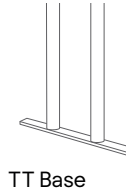
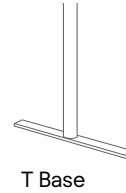
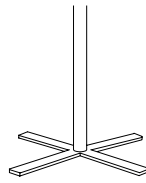
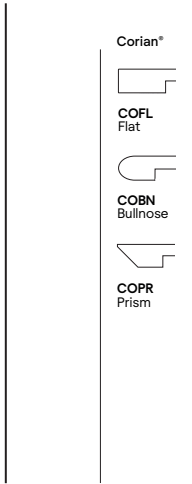

Options

Base Finishes

Custom Powder Coat (set-up charge)	CPC	Call for pricing
Polished or Satin Chrome (per X base)	use finish code	413
Polished or Satin Chrome (T & TT base, per column)	use finish code	207
Premium Plated (per X base)	use finish code	715
Premium Plated (T & TT base, per column)	use finish code	385
Stainless Steel (per base)	use finish code	1,650

Base Options

Counter, Bar, & Alternate Height (per column)	CH, BH, AH	76
Super Level Glides (per base)	GSL	40
Locking Casters 2" Twin Wheel (qty. 4)	TWC2	65
Tilt-top - (standard cable release)	TMX/TMT	312 X-base/ 483 T-base
Folding	FM	312 T-base

Top Materials and Finishes

Any non-standard WCI Laminates (set-up charge)	use manufacturers finish code	165
Premium Laminates	PL	Call for pricing
Custom Wood Veneer	CWV	Call for pricing
Stain to Match (set-up charge)	STM	476

Top Options

3" Radius Corner (per corner) (laminate self edge, Ultrafoam, Corian®, 3form® Chroma®)	CRL3	40
3" Wood Radius Corner (per corner) (not available in LWFL and WWFL)	CRW3	95
Custom Radius Corner	CRC	95
Custom Size	CS	Call for pricing
Custom Shape	CSH	Call for pricing
Custom Edge Thickness	CET	Call for pricing
Ganging Clips (1 set includes 2 male and 2 female clips)	GC	171

Grommets

2" Round Metal Grommet - Matte Black	GMBM	160
2" Round Metal Grommet - Satin Chrome	GMSC	160
2" Round Metal Grommet - Polished Chrome	GMPC	160
2" Round Plastic Grommet - Matte Black	GPMBM	51
Grommet location	use location code	n/c

Power, Data, & Wire Management

Wire management	Pages 234-235
Power & data	Pages 236-237

1,975
2,529
3,199
3,823
4,648
5,533
6,410
-
-
-
-
-
-
-
-
-
-
-
-
-
1,840
2,361
3,012
3,717
4,403

Call for pricing

844.815.2217

PLUS – Dining & Multipurpose

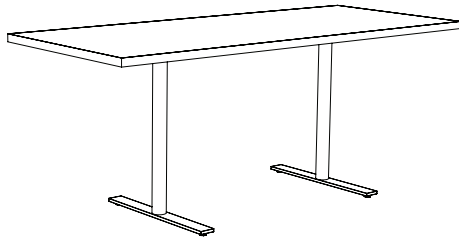

Laminate Surface

Wood Surface

Self Edge	Vinyl Edges	PVC Edges	Wood Edges Group A	Wood Edges Group B	Wood Edges Group A	Wood Edges Group B	Butcher Block
LLSE Self Edge	LVFL Flat	LPVC PVC	LWFL Flat	LWSQ Square	WWFL Flat	WWSQ Square	BBFL Flat
	LVBP Bumper		LWTP Tapered Ply	LWBN Bullnose	WWTP Tapered Ply	WWBN Bullnose	BBBN Bullnose
			LWFP Flat Ply	LWPR Prism	WWFP Flat Ply	WWPR Prism	

Complete Table List Pricing

	Top Size	Base Qty.	Base Style	Model #								
Rectangle	18 48	2	T	PUT1848RE	1,404	1,404	1,484	1,671	2,068	1,775	2,113	2,247
	18 60	2	T	PUT1860RE	1,482	1,482	1,577	1,799	2,247	1,901	2,340	2,355
	18 72	2	T	PUT1872RE	1,557	1,557	1,661	1,933	2,428	2,041	2,565	2,537
	18 84	2	T	PUT1884RE	1,799	1,799	1,881	2,163	2,653	2,313	2,861	2,789
	18 96	2	T	PUT1896RE	1,933	1,933	2,006	2,255	2,833	2,412	3,027	2,969
	24 30	1	X	PUX2430RE	1,306	1,306	1,382	1,689	1,984	1,816	2,112	2,137
	24 36	1	X	PUX2436RE	1,469	1,469	1,552	1,905	2,193	2,010	2,334	2,470
	24 42	1	X	PUX2442RE	1,521	1,521	1,594	1,970	2,289	2,082	2,440	2,776
	24 48	1	X	PUX2448RE	1,579	1,579	1,668	2,086	2,440	2,213	2,607	2,864
	24 60	2	T	PUT2460RE	1,586	1,586	1,682	2,130	2,532	2,270	2,724	3,172
	24 72	2	T	PUT2472RE	1,679	1,679	1,790	2,285	2,745	2,448	2,966	3,571
	24 84	2	T	PUT2484RE	2,024	2,024	2,127	2,415	3,192	2,595	3,471	3,863
	24 96	2	T	PUT2496RE	2,116	2,116	2,231	2,545	3,386	2,739	3,686	4,155
	30 36	1	X	PUX3036RE	1,541	1,541	1,613	1,990	2,305	2,105	2,457	2,741
	30 42	2	T	PUT3042RE	1,617	1,617	1,700	2,159	2,514	2,291	2,690	3,150
	30 48	1	X	PUX3048RE	1,775	1,775	1,865	2,332	2,716	2,476	2,905	3,345
	30 60	2	T	PUT3060RE	1,803	1,803	1,904	2,409	2,848	2,573	3,065	3,719
	30 72	2	T	PUT3072RE	1,912	1,912	2,035	2,529	3,028	2,710	3,266	4,204
	30 84	2	T	PUT3084RE	2,281	2,281	2,386	2,681	3,457	2,878	3,749	4,496
	30 96	2	T	PUT3096RE	2,394	2,394	2,508	2,831	3,732	3,048	4,059	4,787
	36 42	2	T	PUT3642RE	1,808	1,808	1,902	2,365	2,754	2,512	2,945	3,606
	36 48	2	T	PUT3648RE	1,873	1,873	1,971	2,450	2,867	2,605	3,069	3,711
	36 60	2	T	PUT3660RE	2,025	2,025	2,140	2,617	3,089	2,794	3,324	4,263
	36 72	2	T	PUT3672RE	2,156	2,156	2,279	2,822	3,354	3,021	3,623	4,822
	36 84	2	T	PUT3684RE	2,545	2,545	2,657	2,988	3,728	3,210	4,043	5,379
36 96	2	TT	PUTT3696RE	2,879	2,879	3,011	3,357	4,209	3,600	4,556	6,130	

Continued on next page

*T-bases can be specified on 30" x 42" and 30" x 48" rectangle tables, please refer to Base Only Pricing and Top Only Pricing.

X-bases are recommended for dining applications.

How to Order

Table Model Number							Options
PUT Base Series	3672 Top Size	RA Top Shape	WWSQ Top Material Edge Profile	WMW Top Finish	N/A Edge Finish	MBM Base Finish	TWC2 Casters

A PUT3672RAWWSQWMWMBM is a Plus series 36"x 72" racetrack table with two black powder coated T-bases and a wood veneer 1.25" thick top with a 1.25" square wood edge profile.

Edge finish applies when edge material is different from top material.

The code: TWC2 specifies 2" twin wheel locking casters.

Solid Surface

Corian®	
COFL Flat	
COBN Bullnose	
COPR Prism	
-	
-	
-	
-	
-	
2,145	
2,442	
2,619	
2,800	
3,101	
3,480	
-	
-	
2,702	
2,940	
3,282	
3,638	
4,093	
-	
-	
3,662	
4,183	
4,219	
4,740	
-	
-	

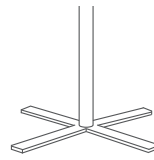

X, XH Base

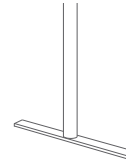

T Base

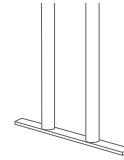

TT Base

Options

Base Finishes

Custom Powder Coat (set-up charge)	CPC		☎
Polished or Satin Chrome (per X base)	use finish code		413
Polished or Satin Chrome (T & TT base, per column)	use finish code		207
Premium Plated (per X base)	use finish code		715
Premium Plated (T & TT base, per column)	use finish code		385
Stainless Steel (per base)	use finish code		1,650

Base Options

Counter, Bar, & Alternate Height (per column)	CH, BH, AH		76
Super Level Glides (per base)	GSL		40
Locking Casters 2" Twin Wheel (qty. 4)	TWC2		65
Tilt-top - (standard cable release)	TMX/TMT	312 X-base/ 483 T-base	
Folding	FM	312 T-base	

Top Materials and Finishes

Any non-standard WCI Laminates (set-up charge)	use manufacturers finish code		165
Premium Laminates	PL		☎
Custom Wood Veneer	CWV		☎
Stain to Match (set-up charge)	STM		476

Top Options

3" Radius Corner (per corner) (laminate self edge, Ultrafoam, Corian®, 3form® Chroma®)	CRL3		40
3" Wood Radius Corner (per corner) (not available in LWFL and WWFL)	CRW3		95
Custom Radius Corner	CRC		95
Custom Size	CS		☎
Custom Shape	CSH		☎
Custom Edge Thickness	CET		☎
Ganging Clips (1 set includes 2 male and 2 female clips)	GC		171

Grommets

2" Round Metal Grommet - Matte Black	GMBM		160
2" Round Metal Grommet - Satin Chrome	GMSC		160
2" Round Metal Grommet - Polished Chrome	GMPC		160
2" Round Plastic Grommet - Matte Black	GPMBM		51
Grommet location	use location code		n/c



















Power, Data, & Wire Management

Wire management		Pages 234-235
Power & data		Pages 236-237

☎ Call for pricing

844.815.2217

PLUS – Dining & Multipurpose

Laminate Surface					Wood Surface			
Self Edge	Vinyl Edges	PVC Edges	Wood Edges Group A	Wood Edges Group B	Wood Edges Group A	Wood Edges Group B	Butcher Block	
 LSE Self Edge	 LVFL Flat	 LPVC PVC	 LWFL Flat	 LWSQ Square	 WWFL Flat	 WWSQ Square	 BBFL Flat	
	 LVBP Bumper		 LWTP Tapered Ply	 LWBN Bullnose	 WWTP Tapered Ply	 WWBN Bullnose	 BBBN Bullnose	
			 LWFP Flat Ply	 LWPR Prism	 WWFP Flat Ply	 WWPR Prism		

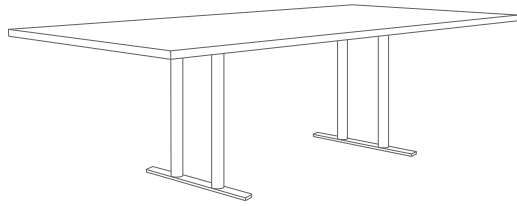

Complete Table List Pricing

	Top Size	Base Qty.	Base Style	Model #								
Rectangle	42 72	2	TT	PUTT4272RE	2,493	2,493	2,596	3,127	3,757	3,240	3,904	-
	42 84	2	TT	PUTT4284RE	2,900	2,900	3,011	3,307	4,117	3,684	4,615	-
	42 96	2	TT	PUTT4296RE	3,049	3,049	3,171	3,501	4,477	3,909	4,684	-
	48 96	2	TT	PUTT4896RE	3,336	3,336	3,456	3,907	4,949	4,499	5,276	-
	48 120	2	TT	PUTT48120RE	3,675	3,675	3,829	4,292	5,310	4,985	5,762	-

How to Order

Table Model Number							Options	
PUT Base Series	3672 Top Size	RE Top Shape	WWSQ Top Material Edge Profile	WMW Top Finish	N/A Edge Finish	MBM Base Finish	GMBM Matte Black Grommet	E Location "E"
<p>A PUT3672REWWSQWMWMBM is a Plus series 36" x 72" rectangle table with two black powder coated T-bases and a wood veneer 1.25" thick top with a 1.25" square wood edge profile.</p>						<p>Edge finish applies when edge material is different from top material.</p>	<p>The code: GMBM specifies a matte black 2" diameter metal grommet.</p>	<p>The code: E specifies the location of the grommet.</p>

Solid Surface

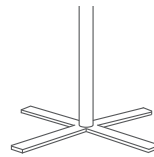
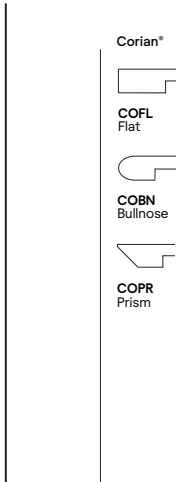

X, XH Base

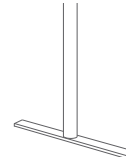

T Base

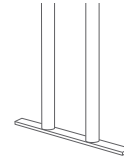

TT Base

Options

Base Finishes

Custom Powder Coat (set-up charge)	CPC	Call for pricing
Polished or Satin Chrome (per X base)	use finish code	413
Polished or Satin Chrome (T & TT base, per column)	use finish code	207
Premium Plated (per X base)	use finish code	715
Premium Plated (T & TT base, per column)	use finish code	385
Stainless Steel (per base)	use finish code	1,650

Base Options

Counter, Bar, & Alternate Height (per column)	CH, BH, AH	76
Super Level Glides (per base)	GSL	40
Locking Casters 2" Twin Wheel (qty. 4)	TWC2	65
Tilt-top - (standard cable release)	TMX/TMT	312 X-base/ 483 T-base
Folding	FM	312 T-base

Top Materials and Finishes

Any non-standard WCI Laminates (set-up charge)	use manufacturers finish code	165
Premium Laminates	PL	Call for pricing
Custom Wood Veneer	CWV	Call for pricing
Stain to Match (set-up charge)	STM	476

Top Options

3" Radius Corner (per corner) (laminate self edge, Ultrafoam, Corian®, 3form® Chroma®)	CRL3	40
3" Wood Radius Corner (per corner) (not available in LWFL and WWFL)	CRW3	95
Custom Radius Corner	CRC	95
Custom Size	CS	Call for pricing
Custom Shape	CSH	Call for pricing
Custom Edge Thickness	CET	Call for pricing
Ganging Clips (1 set includes 2 male and 2 female clips)	GC	171

Grommets

2" Round Metal Grommet - Matte Black	GMBM	160
2" Round Metal Grommet - Satin Chrome	GMSC	160
2" Round Metal Grommet - Polished Chrome	GMPC	160
2" Round Plastic Grommet - Matte Black	GPMBM	51
Grommet location	use location code	n/c











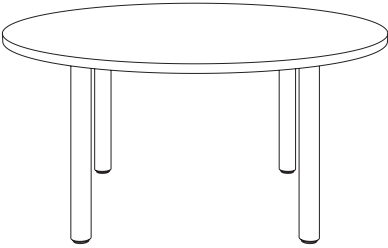







Power, Data, & Wire Management

Wire management	Pages 234-235
Power & data	Pages 236-237





Call for pricing

844.815.2217

POST LEG – Multipurpose

	Laminate Surface				Wood Surface			
	Self Edge	Vinyl Edges	PVC Edges	Wood Edges Group A	Wood Edges Group B	Wood Edges Group A	Wood Edges Group B	Butcher Block
	 LLSE Self Edge	 LVFL Flat	 LPVC PVC	 LWFL Flat	 LWSQ Square	 WWFL Flat	 WWSQ Square	 BBFL Flat
		 LVBP Bumper		 LWTP Tapered Ply	 LWBN Bullnose	 WWTP Tapered Ply	 WWBN Bullnose	 BBBN Bullnose
				 LWFP Flat Ply	 LWPR Prism	 WWFP Flat Ply	 WWPR Prism	

Complete Table List Pricing

	Top Size		Base Qty.	Model #								
Round 	36		4	PO36RD	1,627	1,627	1,742	2,116	2,449	2,157	2,616	2,866
	42		4	PO42RD	1,858	1,858	1,988	2,371	2,782	2,520	2,982	3,772
	48		4	PO48RD	2,023	2,023	2,167	2,592	3,064	2,769	3,300	4,210
	54		4	PO54RD	2,200	2,200	2,367	2,936	3,911	3,156	4,250	-
	60		4	PO60RD	2,481	2,481	2,660	3,126	4,040	3,699	4,400	-
Oval 	36	72	4	PO3672OV	2,097	2,097	2,177	2,508	2,862	2,783	3,127	-
	42	54	4	PO4254OV	2,131	2,131	2,175	2,500	3,020	2,739	3,116	-
	42	78	4	PO4278OV	2,595	2,595	2,662	2,969	3,319	3,196	3,588	-
	42	84	4	PO4284OV	2,684	2,684	2,771	3,048	3,447	3,280	3,732	-
	48	78	4	PO4878OV	2,739	2,739	2,831	3,100	3,496	3,343	3,788	-
	48	96	4	PO4896OV	3,020	3,020	3,110	3,336	3,769	3,913	4,417	-
RD Square 	36	36	4	PO3636RS	1,627	1,627	1,735	2,099	2,449	2,157	2,616	3,053
	42	42	4	PO4242RS	1,838	1,838	1,960	2,372	2,782	2,520	2,982	4,066
	48	48	4	PO4848RS	2,025	2,025	2,167	2,592	3,064	2,769	3,300	4,554
square 	36	36	4	PO3636SQ	1,627	1,627	1,735	2,099	2,449	2,157	2,616	3,053
	42	42	4	PO4242SQ	1,838	1,838	1,960	2,372	2,782	2,520	2,982	4,066
	48	48	4	PO4848SQ	2,025	2,025	2,167	2,592	3,064	2,769	3,300	4,554

Continued on next page

How to Order

Table Model Number							Options
PO Base Series	36 Top Size	RD Top Shape	WWSQ Top Material Edge Profile	WMW Top Finish	N/A Edge Finish	MBM Base Finish	AH Alternate Height Base
<p>A PO36RDWWSQWMWMBM is a Post Leg series 36" round table with four black powder coat post legs and a wood veneer 1.25" thick top with a 1.25" square wood edge profile.</p>				<p>Edge finish applies when edge material is different from top material.</p>		<p>The code: AH specifies alternate height base.</p>	

Solid Surface

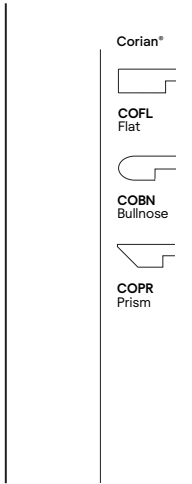

3,226
3,920
4,627
5,398
6,274
-
-
-
-
-
-
-
-
-
-
-
-
-
-
3,038
3,696
4,381

Options

Base Finishes		
Custom Powder Coat (set-up charge)	CPC	88
Polished or Satin Chrome (per leg)	use finish code	88
Premium Plated (per leg)	use finish code	138
Stainless Steel (per leg)	use finish code	1,650

Base Options		
Counter, Bar, & Alternate Height (per column)	CH, BH, AH	76
Locking Casters 2" Twin Wheel (qty. 4)	TWC2	65

Top Materials and Finishes		
Any non-standard WCI Laminates (set-up charge)	use manufacturers finish code	165
Premium Laminates	PL	88
Custom Wood Veneer	CWV	88
Stain to Match (set-up charge)	STM	476

Top Options		
3" Radius Corner (per corner)	CRL3	40
(laminates self edge, Ultrafoam, Corian®, 3form® Chroma®)		
3" Wood Radius Corner (per corner)	CRW3	95
(not available in LWFL and WWFL)		
Custom Radius Corner	CRC	95
Custom Size	CS	88
Custom Shape	CSH	88
Custom Edge Thickness	CET	88

Additional options available Pages 234-235

Grommets		
2" Round Metal Grommet - Matte Black	GMBM	160
2" Round Metal Grommet - Satin Chrome	GMSC	160
2" Round Metal Grommet - Polished Chrome	GMPC	160
2" Round Plastic Grommet - Matte Black	GPMBM	51
Grommet location	use location code	n/c

Call for pricing

844.815.2217

POST LEG – Multipurpose

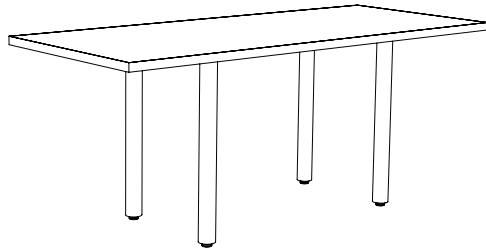

Laminate Surface

Wood Surface

Self Edge	Vinyl Edges	PVC Edges	Wood Edges Group A	Wood Edges Group B	Wood Edges Group A	Wood Edges Group B	Butcher Block
LLSE Self Edge	LVFL Flat	LPVC PVC	LWFL Flat	LWSQ Square	WWFL Flat	WWSQ Square	BBFL Flat
	LVBP Bumper		LWTP Tapered Ply	LWBN Bullnose	WWTP Tapered Ply	WWBN Bullnose	BBBN Bullnose
			LWFP Flat Ply	LWPR Prism	WWFP Flat Ply	WWPR Prism	

Complete Table List Pricing

	Top Size	Base Qty.	Model #								
Rectangle	30 60	4	PO3060RE	1,811	1,811	1,912	2,417	2,856	2,581	3,072	3,727
	30 72	4	PO3072RE	1,920	1,920	2,043	2,537	3,036	2,718	3,274	4,212
	30 84	4	PO3084RE	2,289	2,289	2,394	2,688	3,465	2,885	3,757	4,503
	30 96	4	PO3096RE	2,401	2,401	2,516	2,839	3,740	3,056	4,067	4,795
	36 42	4	PO3642RE	1,700	1,700	1,793	2,256	2,646	2,404	2,836	3,498
	36 48	4	PO3648RE	1,764	1,764	1,862	2,342	2,758	2,496	2,960	3,603
	36 60	4	PO3660RE	1,916	1,916	2,031	2,508	2,980	2,685	3,215	4,154
	36 72	4	PO3672RE	2,047	2,047	2,170	2,713	3,245	2,913	3,515	4,714
	36 84	4	PO3684RE	2,437	2,437	2,549	2,879	3,619	3,101	3,934	5,270
	36 96	4	PO3696RE	2,569	2,569	2,699	3,046	3,897	3,289	4,246	5,820
	42 72	4	PO4272RE	2,252	2,252	2,355	2,886	3,516	2,999	3,663	-
	42 84	4	PO4284RE	2,659	2,659	2,771	3,067	3,878	3,444	4,375	-
	42 96	4	PO4296RE	2,809	2,809	2,930	3,260	4,237	3,669	4,444	-
	48 96	4	PO4896RE	2,984	2,984	3,105	3,555	4,597	4,148	4,925	-
	48 120	6	PO48120RE	3,911	3,911	4,065	4,528	5,545	5,221	5,997	-

How to Order

Table Model Number

PO Base Series	4896 Top Size	RA Top Shape	WWSQ Top Material Edge Profile	WMW Top Finish	N/A Edge Finish	MBM Base Finish
--------------------------	-------------------------	------------------------	---	--------------------------	---------------------------	---------------------------

Options

GMBM Matte Black Grommet	E Location "E"
---------------------------------------	--------------------------

A PO4896RAWWSQWMWMBM is a Post Leg series 48" x 96" racetrack table with four black powder coat post legs and a wood veneer 1.25" thick top with a 1.25" square wood edge profile.

Edge finish applies when edge material is different from top material.

The code: GMBM specifies a matte black 2" diameter metal grommet.

The code: E specifies the location of the grommet.

Solid Surface

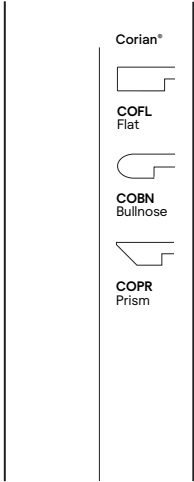

3,644
4,101
-
-
3,553
4,074
4,110
4,631
-
-
-
-
-
-
-
-
-
-

Options

Base Finishes		
Custom Powder Coat (set-up charge)	CPC	88
Polished or Satin Chrome (per leg)	use finish code	88
Premium Plated (per leg)	use finish code	138
Stainless Steel (per leg)	use finish code	1,650

Base Options		
Counter, Bar, & Alternate Height (per column)	CH, BH, AH	76
Locking Casters 2" Twin Wheel (qty. 4)	TWC2	65

Top Materials and Finishes		
Any non-standard WCI Laminates (set-up charge)	use manufacturers finish code	165
Premium Laminates	PL	88
Custom Wood Veneer	CWV	88
Stain to Match (set-up charge)	STM	476











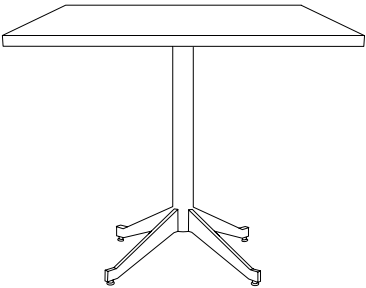







Top Options		
3" Radius Corner (per corner)	CRL3	40
(laminates self edge, Ultrafoam, Corian®, 3form® Chroma®)		
3" Wood Radius Corner (per corner)	CRW3	95
(not available in LWFL and WWFL)		
Custom Radius Corner	CRC	95
Custom Size	CS	88
Custom Shape	CSH	88
Custom Edge Thickness	CET	88

Additional options available Pages 234-235



Grommets		
2" Round Metal Grommet - Matte Black	GMBM	160
2" Round Metal Grommet - Satin Chrome	GMSC	160
2" Round Metal Grommet - Polished Chrome	GMPC	160
2" Round Plastic Grommet - Matte Black	GPMBM	51
Grommet location	use location code	n/c

Call for pricing 844.815.2217

REGENCY – Dining & Multipurpose

	Laminate Surface					Wood Surface						
	Self Edge	Vinyl Edges	PVC Edges	Wood Edges Group A	Wood Edges Group B	Wood Edges Group A	Wood Edges Group B	Butcher Block				
	 LLSE Self Edge	 LVFL Flat	 LPVC PVC	 LWFL Flat	 LWSQ Square	 WWFL Flat	 WWSQ Square	 BBFL Flat				
		 LVBP Bumper		 LWTP Tapered Ply	 LWBN Bullnose	 WWTP Tapered Ply	 WWBN Bullnose	 BBBN Bullnose				
				 LWFP Flat Ply	 LWPR Prism	 WWFP Flat Ply	 WWPR Prism					

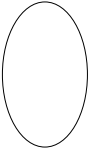





Complete Table List Pricing

	Top Size	Base Qty.	Base Style	Model #								
Round 	30	1	X	RGX30RD	1,931	1,931	2,027	2,345	2,632	2,455	2,772	2,807
	36	1	X	RGX36RD	2,184	2,184	2,299	2,673	3,005	2,714	3,172	3,422
	42	1	X	RGX42RD	2,344	2,344	2,473	2,857	3,267	3,005	3,467	4,258
	48	1	X	RGX48RD	4,378	4,378	4,522	4,948	5,420	5,125	5,656	6,566
	54	1	X	RGX54RD	4,555	4,555	4,722	5,291	6,266	5,512	6,606	-
	60	1	X	RGX60RD	4,836	4,836	5,016	5,481	6,395	6,054	6,755	-
Oval 	36 72	1	S	RGS3672OV	5,630	5,630	5,710	6,041	6,395	6,316	6,661	-
	42 54	1	S	RGS4254OV	5,592	5,592	5,636	5,962	6,482	6,202	6,579	-
	42 78	1	S	RGS4278OV	6,058	6,058	6,124	6,432	6,782	6,658	7,051	-
	42 84	1	S	RGS4284OV	6,324	6,324	6,410	6,688	7,087	6,920	7,372	-
	48 78	1	S	RGS4878OV	6,379	6,379	6,471	6,739	7,136	6,983	7,427	-
	48 96	1	S	RGS4896OV	6,659	6,659	6,749	6,975	7,407	7,552	8,056	-
RD Square 	30 30	1	X	RGX3030RS	1,929	1,929	2,037	2,345	2,632	2,455	2,772	2,955
	36 36	1	X	RGX3636RS	2,184	2,184	2,291	2,655	3,005	2,714	3,172	3,609
	42 42	1	X	RGX4242RS	4,194	4,194	4,315	4,727	5,137	4,875	5,337	6,421
	48 48	1	X	RGX4848RS	4,381	4,381	4,522	4,948	5,420	5,125	5,656	6,910

Continued on next page

How to Order

Table Model Number							Options
RGS Base Series	3672 Top Size	OV Top Shape	WWSQ Top Material Edge Profile	WMW Top Finish	N/A Edge Finish	MBM Base Finish	AH Alternate Height Base
<p>A RGS3672OVWWSQWMWMBM is a Regency series 36" x 72" oval table with a black powder coat scissor base and a wood veneer 1.25" thick top with a 1.25" square wood edge profile.</p>					<p>Edge finish applies when edge material is different from top material.</p>		<p>The code: AH specifies alternate height base.</p>

Solid Surface	Quartz Surface	
Corian®	Caesarstone® Q1	Okite® Q2
		
COFL Flat	Q1FL Flat	Q2FL Flat
		
COBN Bullnose	Q1BN Bullnose	Q2BN Bullnose
		
COPR Prism		

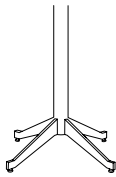

X Base

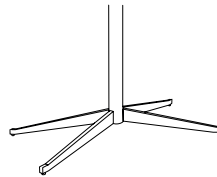

S Base

Options

Base Finishes

Custom Powder Coat (set-up charge)	CPC	☎
Polished or Satin Chrome (per base)	use finish code	825
Premium Plated (per base)	use finish code	1,650

Base Options

Counter, Bar, & Alternate Height (per column)	CH, BH, AH	76
Base sizes may vary with quartz tops		

Top Materials and Finishes

Any non-standard WCI Laminates (set-up charge)	use manufacturers finish code	165
Premium Laminates	PL	☎
Custom Wood Veneer	CWV	☎
Stain to Match (set-up charge)	STM	476

Top Options

3" Radius Corner (per corner) (laminate self edge, Ultrafoam, Corian®, 3form® Chroma®)	CRL3	40
3" Wood Radius Corner (per corner) (not available in LWFL and WWFL)	CRW3	95
Custom Radius Corner	CRC	95
Custom Size	CS	☎
Custom Shape	CSH	☎
Custom Edge Thickness	CET	☎











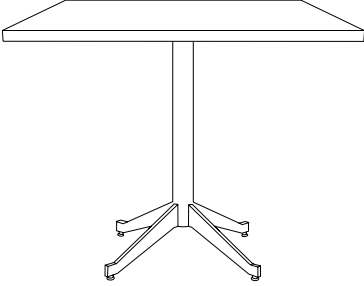







Grommets

2" Round Metal Grommet - Matte Black	GMBM	160
2" Round Metal Grommet - Satin Chrome	GMSC	160
2" Round Metal Grommet - Polished Chrome	GMPC	160
2" Round Plastic Grommet - Matte Black	GPMBM	51
Grommet location	use location code	n/c

3,103	5,563	7,910
3,783	7,323	9,362
4,406	8,686	11,575
6,982	-	-
7,753	-	-
8,630	-	-
-	-	-
-	-	-
-	-	-
-	-	-
-	-	-
-	-	-
-	-	-
-	-	-
-	-	-
-	-	-
-	-	-
-	-	-
-	-	-
-	-	-
-	-	-
-	-	-
-	-	-
-	-	-
-	-	-
-	-	-
-	-	-
-	-	-
-	-	-
-	-	-
-	-	-

☎ Call for pricing

REGENCY – Dining & Multipurpose

	Laminate Surface				Wood Surface			
	Self Edge	Vinyl Edges	PVC Edges	Wood Edges Group A	Wood Edges Group B	Wood Edges Group A	Wood Edges Group B	Butcher Block
	 LLSE Self Edge	 LVFL Flat	 LPVC PVC	 LWFL Flat	 LWSQ Square	 WWFL Flat	 WWSQ Square	 BBFL Flat
		 LVBP Bumper		 LWTP Tapered Ply	 LWBN Bullnose	 WWTP Tapered Ply	 WWBN Bullnose	 BBBN Bullnose
				 LWFP Flat Ply	 LWPR Prism	 WWFP Flat Ply	 WWPR Prism	

Complete Table List Pricing

	Top Size		Base Qty.	Base Style	Model #								
	30	30	1	X	RGX3030SQ	1,929	1,929	2,037	2,345	2,632	2,455	2,772	2,955
	36	36	1	X	RGX3636SQ	2,184	2,184	2,291	2,655	3,005	2,714	3,172	3,609
	42	42	1	X	RGX4242SQ	4,194	4,194	4,315	4,727	5,137	4,875	5,337	6,421
	48	48	1	X	RGX4848SQ	4,381	4,381	4,522	4,948	5,420	5,125	5,656	6,910
Rectangle	30	48	1	X	RGX3048RE	2,240	2,240	2,329	2,796	3,180	2,940	3,369	3,809

How to Order

Table Model Number							Options
RGS Base Series	3672 Top Size	OV Top Shape	WWSQ Top Material Edge Profile	WMW Top Finish	N/A Edge Finish	MBM Base Finish	AH Alternate Height Base
<p>A RGS3672OVWWSQWMWMBM is a Regency series 36" x 72" oval table with a black powder coat scissor base and a wood veneer 1.25" thick top with a 1.25" square wood edge profile.</p>					<p>Edge finish applies when edge material is different from top material.</p>		<p>The code: AH specifies alternate height base.</p>

Solid Surface	Quartz Surface	
Corian®	Caesarstone® Q1	Okite® Q2
COFL Flat	Q1FL Flat	Q2FL Flat
COBN Bullnose	Q1BN Bullnose	Q2BN Bullnose
COPR Prism		

2,935	4,786	7,019
3,595	5,891	8,561
6,051	9,420	12,199
6,738	-	-

3,747	-	-
-------	---	---

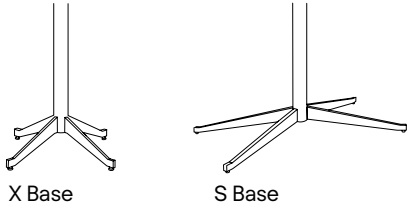

Options

Base Finishes		
Custom Powder Coat (set-up charge)	CPC	Call for pricing
Polished or Satin Chrome (per base)	use finish code	825
Premium Plated (per base)	use finish code	1,650

Base Options		
Counter, Bar, & Alternate Height (per column)	CH, BH, AH	76
Base sizes may vary with quartz tops		

Top Materials and Finishes		
Any non-standard WCI Laminates (set-up charge)	use manufacturers finish code	165
Premium Laminates	PL	Call for pricing
Custom Wood Veneer	CWV	Call for pricing
Stain to Match (set-up charge)	STM	476



















Top Options		
3" Radius Corner (per corner) (laminate self edge, Ultrafoam, Corian®, 3form® Chroma®)	CRL3	40
3" Wood Radius Corner (per corner) (not available in LWFL and WWFL)	CRW3	95
Custom Radius Corner	CRC	95
Custom Size	CS	Call for pricing
Custom Shape	CSH	Call for pricing
Custom Edge Thickness	CET	Call for pricing

Grommets		
2" Round Metal Grommet - Matte Black	GMBM	160
2" Round Metal Grommet - Satin Chrome	GMSC	160
2" Round Metal Grommet - Polished Chrome	GMPC	160
2" Round Plastic Grommet - Matte Black	GPMBM	51
Grommet location	use location code	n/c





Call for pricing

844.815.2217

TULIP – Dining & Multipurpose

	Laminate Surface					Wood Surface						
	Self Edge	Vinyl Edges	PVC Edges	Wood Edges Group A	Wood Edges Group B	Wood Edges Group A	Wood Edges Group B	Butcher Block				
	 LLSE Self Edge	 LVFL Flat	 LPVC PVC	 LWFL Flat	 LWSQ Square	 WWFL Flat	 WWSQ Square	 BBFL Flat				
		 LVBP Bumper		 LWTP Tapered Ply	 LWBN Bullnose	 WWTP Tapered Ply	 WWBN Bullnose	 BBBN Bullnose				
				 LWFP Flat Ply	 LWPR Prism	 WWFP Flat Ply	 WWPR Prism					

Complete Table List Pricing

	Top Size	Base Qty.	Base Style	Model #								
Round 	24	1	18L	TL24RD	1,255	1,255	1,334	1,587	1,856	1,603	1,971	1,837
	30	1	18M	TL30RD	1,440	1,440	1,537	1,855	2,142	1,965	2,280	2,317
	36	1	18H	TL36RD	1,679	1,679	1,794	2,168	2,501	2,209	2,668	2,917
	42	1	24M	TL42RD	1,901	1,901	2,031	2,413	2,825	2,563	3,025	3,815
	48	1	24H	TL48RD	2,251	2,251	2,395	2,819	3,291	2,996	3,528	4,437
	54	1	24XH	TL54RD	2,482	2,482	2,649	3,219	4,192	3,439	4,532	-
Oval 	36	72	2 18H	TL3672OV	3,303	3,303	3,384	3,716	4,070	3,990	4,334	-
	42	54	2 18H	TL4254OV	3,266	3,266	3,310	3,636	4,156	3,875	4,253	-
	42	78	2 24M	TL4278OV	3,854	3,854	3,922	4,228	4,579	4,456	4,848	-
	42	84	2 24M	TL4284OV	3,945	3,945	4,030	4,309	4,708	4,541	4,993	-
	48	78	2 24H	TL4878OV	4,369	4,369	4,461	4,729	5,125	4,972	5,418	-
	48	96	2 24H	TL4896OV	4,650	4,650	4,739	4,965	5,398	5,542	6,047	-
RD Square 	24	24	1 18L	TL2424RS	1,257	1,257	1,344	1,587	1,856	1,603	1,971	1,948
	30	30	1 18M	TL3030RS	1,439	1,439	1,547	1,855	2,142	1,965	2,280	2,463
	36	36	1 18H	TL3636RS	1,680	1,680	1,786	2,151	2,501	2,209	2,669	3,104
	42	42	1 24H	TL4242RS	2,066	2,066	2,188	2,599	3,010	2,748	3,210	4,293
	48	48	1 24XH	TL4848RS	2,308	2,308	2,450	2,874	3,346	3,051	3,583	4,837
Square 	24	24	1 18L	TL2424SQ	1,257	1,257	1,344	1,587	1,856	1,603	1,971	1,948
	30	30	1 18M	TL3030SQ	1,439	1,439	1,547	1,855	2,142	1,965	2,280	2,463
	36	36	1 18H	TL3636SQ	1,680	1,680	1,786	2,151	2,501	2,209	2,669	3,104
	42	42	1 24H	TL4242SQ	2,066	2,066	2,188	2,599	3,010	2,748	3,210	4,293
	48	48	1 24XH	TL4848SQ	2,308	2,308	2,450	2,874	3,346	3,051	3,583	4,837

Continued on next page

How to Order

Table Model Number							Options
TL Base Series	36 Top Size	RD Top Shape	WWSQ Top Material Edge Profile	WMW Top Finish	N/A Edge Finish	MBM Base Finish	GSL Super Level Glides







A TL36RDWWSQWMWMBM is a Tulip series 36" round table with a black powder coat, round base and a wood veneer 1.25" thick top with a 1.25" square wood edge profile.

Edge finish applies when edge material is different from top material.

The code: GSL specifies super level glides.

Solid Surface

Quartz Surface

Corian®	Caesarstone® Q1	Okite® Q2
		
COFL Flat	Q1FL Flat	Q2FL Flat
		
COBN Bullnose	Q1BN Bullnose	Q2BN Bullnose
		
COPR Prism		

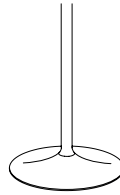

2,091	4,017	5,344	
2,613	5,071	7,420	
3,278	6,819	8,857	
3,963	8,242	11,132	
4,854	-	-	
5,680	-	-	
-	-	-	
-	-	-	
-	-	-	
-	-	-	
-	-	-	
-	-	-	
-	-	-	
-	-	-	
-	-	-	
-	-	-	
1,957	2,828	4,673	
2,443	4,296	6,529	
3,090	5,386	8,056	
3,924	7,293	10,071	
4,664	-	-	

Options

Base Finishes

Custom Powder Coat (set-up charge)	CPC	☎
Polished or Satin Chrome (per base)	use finish code	275
Premium Plated (per base)	use finish code	550
Stainless Steel (per base)	use finish code	1,650

Base Options

Counter, Bar, & Alternate Height (per column)	CH, BH, AH	76
Super Level Glides (per base)	GSL	40
Custom Top Plate Size	CTPS	☎
6" Column (black texture and powder coat)	COL6	224
6" Column (polished or satin chrome)	COLP6	286
6" Column (premium plated)	COLPP6	☎
6" Column (veneer)	COLV6	446

Top Materials and Finishes

Any non-standard WCI Laminates (set-up charge)	use manufacturers finish code	165
Premium Laminates	PL	☎
Custom Wood Veneer	CWV	☎
Stain to Match (set-up charge)	STM	476

Top Options

3" Radius Corner (per corner) (laminare self edge, Ultrafoam, Corian®, 3form® Chroma®)	CRL3	40
3" Wood Radius Corner (per corner) (not available in LWFL and WWFL)	CRW3	95
Custom Size	CS	☎
Custom Radius Corner	CRC	95
Custom Shape	CSH	☎
Custom Edge Thickness	CET	☎

Grommets

2" Round Metal Grommet - Matte Black	GMBM	160
2" Round Metal Grommet - Satin Chrome	GMSC	160
2" Round Metal Grommet - Polished Chrome	GMPC	160
2" Round Plastic Grommet - Matte Black	GPMBM	51
Grommet location	use location code	n/c

☎ Call for pricing

844.815.2217

TULIP – Dining & Multipurpose

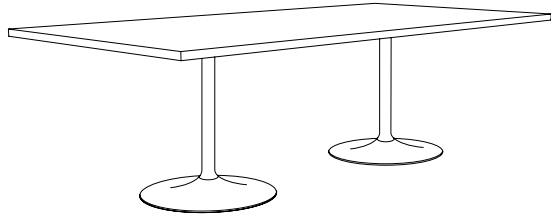

Laminate Surface

Wood Surface

Self Edge	Vinyl Edges	PVC Edges	Wood Edges Group A	Wood Edges Group B	Wood Edges Group A	Wood Edges Group B	Butcher Block
LLSE Self Edge	LVFL Flat	LPVC PVC	LWFL Flat	LWSQ Square	WWFL Flat	WWSQ Square	BBFL Flat
	LVBP Bumper		LWTP Tapered Ply	LWBN Bullnose	WWTP Tapered Ply	WWBN Bullnose	BBBN Bullnose
			LWFP Flat Ply	LWPR Prism	WWFP Flat Ply	WWPR Prism	

Complete Table List Pricing

	Top Size		Base Qty.	Base Style	Model #								
Rectangle	24	30	1	18M	TL2430RE	1,389	1,389	1,464	1,772	2,068	1,900	2,196	2,221
	24	36	1	18H	TL2436RE	1,548	1,548	1,631	1,983	2,272	2,089	2,413	2,548
	24	42	1	24M	TL2442RE	1,662	1,662	1,734	2,111	2,430	2,223	2,580	2,917
	24	48	1	24H	TL2448RE	1,903	1,903	1,992	2,410	2,764	2,538	2,932	3,190
	24	60	2	18L	TL2460RE	2,509	2,509	2,606	3,054	3,456	3,193	3,648	4,096
	24	72	2	18L	TL2472RE	2,602	2,602	2,714	3,208	3,669	3,370	3,890	4,495
	24	84	2	18L	TL2484RE	2,947	2,947	3,050	3,339	4,116	3,518	4,393	4,786
	24	96	2	18L	TL2496RE	3,039	3,039	3,154	3,468	4,309	3,663	4,609	5,078
	30	36	1	18H	TL3036RE	1,619	1,619	1,691	2,069	2,384	2,184	2,537	2,819
	30	42	1	24M	TL3042RE	1,738	1,738	1,821	2,281	2,636	2,412	2,811	3,271
	30	48	1	24H	TL3048RE	1,981	1,981	2,070	2,538	2,922	2,683	3,112	3,551
	30	60	2	18M	TL3060RE	2,792	2,792	2,894	3,398	3,837	3,563	4,055	4,709
	30	72	2	18M	TL3072RE	2,901	2,901	3,024	3,519	4,017	3,700	4,255	5,193
	30	84	2	18M	TL3084RE	3,270	3,270	3,376	3,670	4,446	3,868	4,739	5,485
	30	96	2	18M	TL3096RE	3,383	3,383	3,497	3,820	4,721	4,037	5,049	5,777
	36	42	1	24M	TL3642RE	1,814	1,814	1,907	2,371	2,760	2,518	2,950	3,611
	36	48	1	24H	TL3648RE	2,064	2,064	2,162	2,640	3,057	2,794	3,259	3,901
	36	60	2	18H	TL3660RE	3,123	3,123	3,238	3,716	4,188	3,893	4,422	5,360
	36	72	2	18H	TL3672RE	3,254	3,254	3,377	3,919	4,452	4,120	4,721	5,920
	36	84	2	18H	TL3684RE	3,643	3,643	3,755	4,085	4,826	4,308	5,140	6,477
	36	96	2	18H	TL3696RE	3,775	3,775	3,906	4,253	5,104	4,496	5,453	7,027
	42	72	2	24M	TL4272RE	3,512	3,512	3,616	4,147	4,776	4,259	4,924	-
	42	84	2	24M	TL4284RE	3,918	3,918	4,030	4,326	5,137	4,704	5,634	-
	42	96	2	24M	TL4296RE	4,069	4,069	4,191	4,521	5,497	4,929	5,704	-
48	96	2	24H	TL4896RE	4,613	4,613	4,734	5,185	6,226	5,777	6,554	-	
48	120	2	24H	TL48120RE	4,952	4,952	5,107	5,570	6,588	6,263	7,040	-	

How to Order

Table Model Number

Options

TL Base Series	4896 Top Size	RA Top Shape	WWSQ Top Material Edge Profile	WMW Top Finish	N/A Edge Finish	MBM Base Finish
--------------------------	-------------------------	------------------------	---	--------------------------	---------------------------	---------------------------

GMBM Matte Black Grommet	C Location "C"
---------------------------------------	--------------------------

A TL4896RAWWSQWMWMBM is a Tulip series 48" x 96" racetrack table with two black powder coat, round bases and a wood veneer 1.25" thick top with a 1.25" square wood edge profile.







Edge finish applies when edge material is different from top material.

The code: GMBM specifies a matte black 2" diameter metal grommet.

The code: C specifies the location of the grommet.

Solid Surface

Quartz Surface

Corian®	Caesarstone® Q1	Okite® Q2
		
COFL Flat	Q1FL Flat	Q2FL Flat
		
COBN Bullnose	Q1BN Bullnose	Q2BN Bullnose
		
COPR Prism		

2,229	2,895	5,290
2,521	3,274	5,933
2,760	3,706	6,348
3,124	-	-
4,024	-	-
4,403	-	-
-	-	-
-	-	-
2,780	3,948	6,818
3,061	4,255	7,057
3,488	-	-
4,627	-	-
5,083	-	-
-	-	-
-	-	-
3,666	4,946	8,225
4,373	-	-
5,316	-	-
5,838	-	-
-	-	-
-	-	-
-	-	-
-	-	-
-	-	-
-	-	-
-	-	-
-	-	-
-	-	-

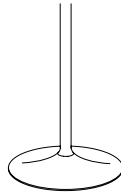

Options

Base Finishes

Custom Powder Coat (set-up charge)	CPC	📞
Polished or Satin Chrome (per base)	use finish code	275
Premium Plated (per base)	use finish code	550
Stainless Steel (per base)	use finish code	1,650

Base Options

Counter, Bar, & Alternate Height (per column)	CH, BH, AH	76
Super Level Glides (per base)	GSL	40
Custom Top Plate Size	CTPS	📞
6" Column (black texture and powder coat)	COL6	224
6" Column (polished or satin chrome)	COLP6	286
6" Column (premium plated)	COLPP6	📞
6" Column (veneer)	COLV6	446

Top Materials and Finishes

Any non-standard WCI Laminates (set-up charge)	use manufacturers finish code	165
Premium Laminates	PL	📞
Custom Wood Veneer	CWV	📞
Stain to Match (set-up charge)	STM	476

Top Options

3" Radius Corner (per corner) (laminated self edge, Ultrafoam, Corian®, 3form® Chroma®)	CRL3	40
3" Wood Radius Corner (per corner) (not available in LWFL and WWFL)	CRW3	95
Custom Size	CS	📞
Custom Radius Corner	CRC	95
Custom Shape	CSH	📞
Custom Edge Thickness	CET	📞







Grommets

2" Round Metal Grommet - Matte Black	GMBM	160
2" Round Metal Grommet - Satin Chrome	GMSC	160
2" Round Metal Grommet - Polished Chrome	GMPC	160
2" Round Plastic Grommet - Matte Black	GPMBM	51
Grommet location	use location code	n/c

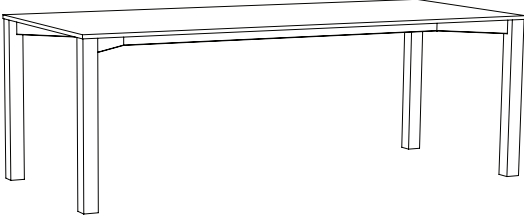

📞 Call for pricing

844.815.2217

VISTA – Dining & Multipurpose

	Laminate Surface		Wood Surface	
	Self Edge	Wood Edges Group A	Wood Edges Group A	Butcher Block
	 LLSE Self Edge	 LWFL Flat	 WWFL Flat	 BBFL Flat
		 LWFP Flat Ply	 WWFP Flat Ply	

Complete Table List Pricing

	Top Size	Base Qty.	Model #				
Square 	36 36	1	VS3636SQ	2,662	3,042	3,432	3,994
	42 42	1	VS4242SQ	2,874	3,254	3,719	4,233
	48 48	1	VS4848SQ	3,577	4,050	4,630	5,269
Rectangle 	24 60	1	VS2460RE	2,498	2,861	3,231	3,494
	24 72	1	VS2472RE	2,899	3,320	3,747	4,051
	24 84	1	VS2484RE	3,284	3,762	4,247	4,594
	24 96	1	VS2496RE	3,660	4,192	4,732	5,117
	24 120	1	VS24120RE	4,391	5,029	5,678	6,141
	30 60	1	VS3060RE	3,122	3,576	4,038	4,367
	30 72	1	VS3072RE	3,341	3,827	4,321	4,765
	30 84	1	VS3084RE	3,575	4,095	4,623	5,176
	30 96	1	VS3096RE	3,983	4,563	5,151	5,767
	30 120	1	VS30120RE	4,781	5,475	6,182	6,920
	36 60	1	VS3660RE	3,211	3,755	4,241	4,711
	36 72	1	VS3672RE	3,434	4,019	4,536	5,104
	36 84	1	VS3684RE	3,675	4,300	4,854	5,471
	36 96	1	VS3696RE	4,095	4,791	5,409	6,097
	36 120	1	VS36120RE	4,915	5,750	6,491	7,317
	42 60	1	VS4260RE	3,383	4,038	4,452	4,959
	42 72	1	VS4272RE	3,619	4,321	4,764	5,356
	42 84	1	VS4284RE	3,873	4,623	5,096	5,785
	42 96	1	VS4296RE	4,315	5,151	5,680	6,445
42 120	1	VS42120RE	5,179	6,182	6,816	7,735	

How to Order



Table Model Number

VS Base Series	3684 Top Size	RE Top Shape	LWFL Top Material Edge Profile	LDW Top Finish	WMW Edge Finish	MBM Base Finish
--------------------------	-------------------------	------------------------	---	--------------------------	---------------------------	---------------------------

A VS3684RELWFLLDWWMWMBM is a Vista series 36" x 84" rectangle table with a black powder coat base and a laminate 1.25" thick top with a 1.25" flat wood edge profile.

The codes: LDW WMW specify a designer white laminate top, with a medium walnut edge.

Solid Surface Quartz

Corian®	Caesarstone® Q1	Okite® Q2
		
COFL Flat	Q1FL Flat	Q2FL Flat

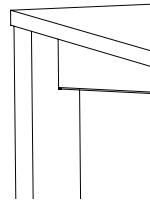

4,252	5,026	7,366
4,549	6,243	8,659
5,662	7,770	10,780
3,770	5,119	7,599
4,374	5,938	8,815
4,957	6,730	9,991
5,523	7,499	11,132
6,628	8,999	13,358
4,712	6,399	9,499
5,094	7,704	13,756
5,530	10,172	14,886
6,162	11,334	16,588
7,394	13,602	19,906
5,270	6,763	9,820
5,680	8,154	14,112
6,078	10,814	14,915
6,772	12,052	16,619
8,127	14,462	19,943
5,839	8,201	9,941
6,248	10,024	14,196
6,686	13,529	15,092
7,449	15,076	16,817
8,939	18,091	20,180

Options

Base Finishes

Custom Powder Coat (set-up charge)	CPC	2,310
Stainless Steel	use finish code	

Base Options

Counter Height	CH	pages 147-148
Bar Height	BH	pages 147-148
Alternate Height	AH	
Locking Casters 3" Mag Wheel (qty 4)	MWC3	193

Top Materials and Finishes

Any non-standard WCI Laminates (set-up charge)	use manufacturers finish code	165
Premium Laminates	PL	
Custom Wood Veneer	CWV	
Stain to Match (set-up charge)	STM	476



Call for pricing

844.815.2217

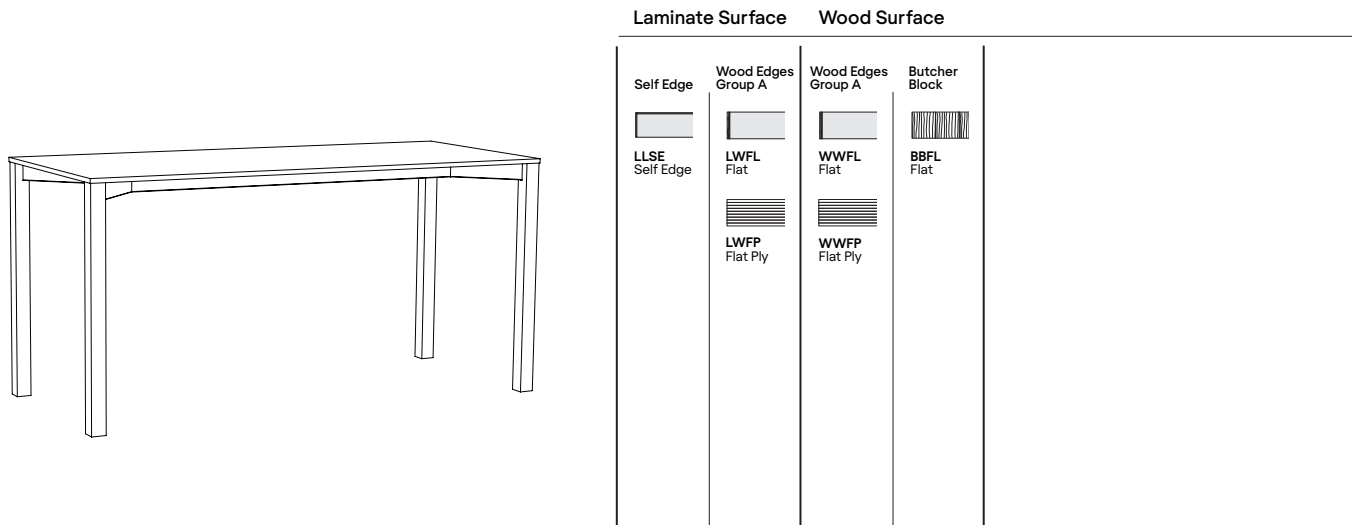
VISTA – Dining & Multipurpose - Counter & Bar Height



Complete Table List Pricing

	Top Size	Base Qty.	Model #				
Square 	36 36	1	VS3636SQ	3,104	3,484	3,874	4,436
	42 42	1	VS4242SQ	3,317	3,696	4,162	4,675
	48 48	1	VS4848SQ	4,021	4,494	5,073	5,711
Rectangle 	24 60	1	VS2460RE	2,941	3,304	3,674	3,937
	24 72	1	VS2472RE	3,341	3,762	4,190	4,495
	24 84	1	VS2484RE	3,727	4,205	4,689	5,036
	24 96	1	VS2496RE	4,102	4,635	5,176	5,559
	24 120	1	VS24120RE	4,833	5,473	6,122	6,585
	30 60	1	VS3060RE	3,565	4,019	4,480	4,809
	30 72	1	VS3072RE	3,784	4,269	4,764	5,209
	30 84	1	VS3084RE	4,017	4,538	5,067	5,618
	30 96	1	VS3096RE	4,426	5,006	5,594	6,210
	30 120	1	VS30120RE	5,223	5,918	6,625	7,362
	36 60	1	VS3660RE	3,653	4,199	4,683	5,154
	36 72	1	VS3672RE	3,878	4,462	4,979	5,547
	36 84	1	VS3684RE	4,117	4,742	5,297	5,914
	36 96	1	VS3096RE	4,538	5,234	5,852	6,541
	36 120	1	VS30120RE	5,357	6,192	6,933	7,759
	42 60	1	VS4260RE	3,826	4,480	4,894	5,402
	42 72	1	VS4272RE	4,062	4,764	5,206	5,799
	42 84	1	VS4284RE	4,316	5,067	5,540	6,227
	42 96	1	VS4296RE	4,758	5,594	6,123	6,888
	42 120	1	VS42120RE	5,622	6,625	7,259	8,179

How to Order

Table Model Number						Options	
VS	3684	RE	LWFL	LDW	WMW	MBM	BH
Base Series	Top Size	Top Shape	Top Material Edge Profile	Top Finish	Edge Finish	Base Finish	Base Height



A VS3684RELWFLLDWWMWMBM-BH is a Vista series 36" x 84" rectangle table with a black powder coat base and a laminate 1.25" thick top with a 1.25" flat wood edge profile.

The codes: LDW WMW specify a designer white laminate top, with a medium walnut edge.

The code: BH specifies bar height base.

Dining & Multipurpose - Counter & Bar Height – VISTA

Solid Surface Quartz

Corian®	Caesarstone® Q1	Okite® Q2
		
COFL Flat	Q1FL Flat	Q2FL Flat

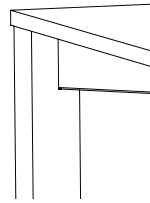

Options

Base Finishes

Custom Powder Coat (set-up charge)	CPC	2,310
Stainless Steel	use finish code	

Base Options

Counter Height	CH	pages 147-148
Bar Height	BH	pages 147-148
Alternate Height	AH	
Locking Casters 3" Mag Wheel (qty 4)	MWC3	193

Top Materials and Finishes

Any non-standard WCI Laminates (set-up charge)	use manufacturers finish code	165
Premium Laminates	PL	
Custom Wood Veneer	CWV	
Stain to Match (set-up charge)	STM	476

4,695	5,468	7,809
4,992	6,686	9,101
6,105	8,214	11,223

4,213	5,563	8,042
4,816	6,381	9,259
5,399	7,173	10,434
5,965	7,942	11,575
7,070	9,442	13,802

5,155	6,841	9,942
5,537	8,147	14,199
5,972	10,615	15,330
6,604	11,778	17,030
7,836	14,044	

5,712	7,205	10,263
6,123	8,597	14,555
6,520	11,257	15,357
7,214	12,495	17,061
8,569	14,904	

6,282	8,644	10,383
6,690	10,467	14,639
7,128	13,972	15,534
7,893	15,518	17,260
9,381	18,534	

Call for pricing

844.815.2217

Occasional Tables

126	Blok
128	Brae
130	Cube
132	Cylinder
134	Disc
136	Kone
138	Move
140	Parsons
144	Platform
146	Triad

BLOK – Occasional

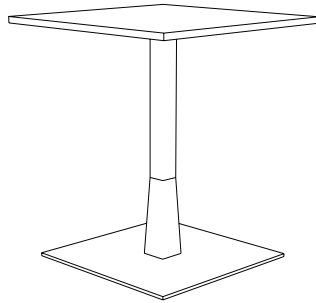

Laminate Surface		Wood Surface		Solid Surface	
LMFC Mini Facet Ply	LFCT Facet Ply	WMFC Mini Facet Ply	WFCT Facet Ply	COFM Mini Facet	COFC Facet

Complete Table List Pricing

	Top Size		Table Height	Base Qty.	Model #						
Square 	17	17	16	1	BL17SQ16	1,497	-	1,610	-	1,760	-
			18	1	BL17SQ18	1,497	-	1,610	-	1,760	-
			20	1	BL17SQ20	1,497	-	1,610	-	1,760	-
	20	20	16	1	BL20SQ16	1,580	-	1,662	-	1,870	-
			18	1	BL20SQ18	1,580	-	1,662	-	1,870	-
			20	1	BL20SQ20	1,580	-	1,662	-	1,870	-
	24	24	16	1	BL24SQ16	-	2,050	-	2,065	-	2,364
			18	1	BL24SQ18	-	2,050	-	2,065	-	2,364
			20	1	BL24SQ20	-	2,050	-	2,065	-	2,364
	30	30	16	1	BL30SQ16	-	2,226	-	2,226	-	2,736
			18	1	BL30SQ18	-	2,226	-	2,226	-	2,736
			20	1	BL30SQ20	-	2,226	-	2,226	-	2,736
	36	36	16	1	BL36SQ16	-	2,627	-	2,683	-	3,454
			18	1	BL36SQ18	-	2,627	-	2,683	-	3,454
			20	1	BL36SQ20	-	2,627	-	2,683	-	3,454
	42	42	16	1	BL42SQ16	-	2,824	-	2,969	-	3,999
			18	1	BL42SQ18	-	2,824	-	2,969	-	3,999
			20	1	BL42SQ20	-	2,824	-	2,969	-	3,999

How to Order

Table Model Number

BL Table Series	1717 Top Size	SQ Top Shape	18 Table Height	WMFC Top Material	WNM Top Finish	MBM Base Finish	WNM Wood Column Finish
---------------------------	-------------------------	------------------------	---------------------------	-----------------------------	--------------------------	---------------------------	----------------------------------

A BL1717SQ18WMFCWNM is a Blok series 17" x 17" square x 18" high occasional table with a black powder coat base and a wood veneer top .5" thick top with a .5" facet wood edge profile.

The code: WNM specifies a natural maple top.

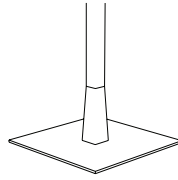

Options

Base Finishes

Custom Powder Coat (set-up charge)	CPC	📞
Polished or Satin Chrome (per column)	use finish code	660
Premium Plated (per base)	use finish code	1,430
Stainless Steel Column and Base Cover (per base)	use finish code	1,650

Top Materials and Finishes

Any non-standard WCI Laminates (set-up charge)	use manufacturers finish code	165
Premium Laminates	PL	A
Custom Wood Veneer	CWV	📞
Stain to Match (set-up charge)	STM	476

Top Options

Custom Size	CS	📞
-------------	----	---

📞 Call for pricing

844.815.2217

BRAE – Occasional

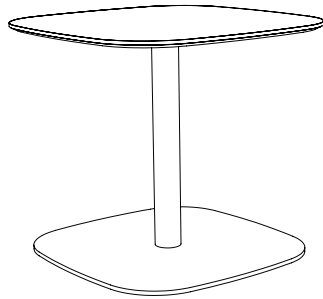

Laminate Surface Wood Surface Solid Surface

Laminate		Veneer		Corian®	
LMFC Mini Facet Ply	LFCT Facet Ply	WMFC Mini Facet Ply	WFCT Facet Ply	COFM Mini Facet	COFC Facet

Complete Table List Pricing

	Top Size	Table Height	Base Qty.	Model #							
RD Square	20	20	16	1	BR2020RS16	1,267	-	1,283	-	1,576	-
	20	20	18	1	BR2020RS18	1,267	-	1,283	-	1,576	-
	20	20	20	1	BR2020RS20	1,267	-	1,283	-	1,576	-
	24	24	16	1	BR2424RS16	-	1,374	-	1,389	-	1,744
	24	24	18	1	BR2424RS18	-	1,374	-	1,389	-	1,744
	24	24	20	1	BR2424RS20	-	1,374	-	1,389	-	1,744
	30	30	16	1	BR3030RS16	-	1,553	-	1,569	-	2,143
	30	30	18	1	BR3030RS18	-	1,553	-	1,569	-	2,143
	36	36	16	1	BR3636RS16	-	2,010	-	2,068	-	2,950
	36	36	18	1	BR3636RS18	-	2,010	-	2,068	-	2,950
						-	-	-	-	-	-
	42	42	16	1	BR4242RS16	-	2,211	-	2,361	-	3,537
	42	42	18	1	BR4242RS18	-	2,211	-	2,361	-	3,537

How to Order

Table Model Number

BR Table Series	1717 Top Size	RS Top Shape	18 Table Height	WMFC Top Material	WNM Top Finish	MBM Base Finish	WNM Wood Column Finish
---------------------------	-------------------------	------------------------	---------------------------	-----------------------------	--------------------------	---------------------------	----------------------------------

A BR1717RS18WMFCWNMMBMWNM is a Brae series 17" x 17" RD Square x 18" high occasional table with a black powder coat base and a wood veneer top .5" thick top with a .5" facet wood edge profile.

The code: WNM specifies a natural maple top.

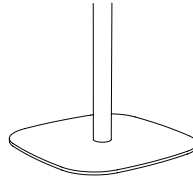

Options

Base Finishes

Custom Powder Coat (set-up charge)	CPC	📞
Polished or Satin Chrome (per column)	use finish code	660
Premium Plated (per base)	use finish code	1,430
Stainless Steel Column and Base Cover (per base)	use finish code	1,650

Top Materials and Finishes

Any non-standard WCI Laminates (set-up charge)	use manufacturers finish code	165
Premium Laminates	PL	📞
Custom Wood Veneer	CWV	📞
Stain to Match (set-up charge)	STM	476

Top Options

Custom Size	CS	📞
-------------	----	---

📞 Call for pricing

844.815.2217

CUBE – Occasional

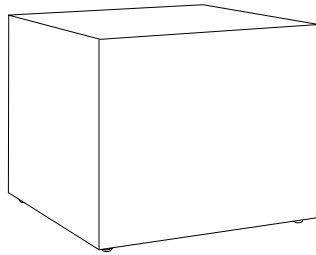

Laminate	Overlay	Wood	Overlay
Laminate LAM Laminate	Corian® COLAM Corian® Top	Okite® Q2 QOLAM Okite® Quartz Top (Q2)	Veneer VEN Wood Veneer
			Corian® COVEN Corian® Top
			Okite® Q2 QOVEN Okite® Quartz Top (Q2)

Complete Table List Pricing

	Top Size		Table Height	Model #						
Square 	18	18	18	CU1818SQ18	792	1,216	2,775	1,220	1,643	3,203
			20	CU1818SQ20	851	1,275	2,835	1,293	1,716	3,276
			24	CU1818SQ24	934	1,357	2,917	1,396	1,819	3,379
	20	20	18	CU2020SQ18	870	1,342	2,924	1,285	1,708	3,340
			20	CU2020SQ20	933	1,404	2,987	1,360	1,784	3,414
			24	CU2020SQ24	1,020	1,492	3,075	1,471	1,894	3,526
	24	24	18	CU2424SQ18	993	1,577	3,401	1,397	1,821	3,806
			20	CU2424SQ20	1,062	1,645	3,469	1,476	1,900	3,885
			24	CU2424SQ24	1,159	1,742	3,567	1,594	2,017	4,003
	30	30	16	CU3030SQ16	1,133	1,964	4,038	1,683	2,107	4,588
			18	CU3030SQ18	1,209	2,038	4,113	1,782	2,206	4,687
	36	36	16	CU3636SQ16	1,324	2,560	5,292	1,845	2,268	5,811
18			CU3636SQ18	1,407	2,642	5,374	1,915	2,339	5,883	
Rectangle 	20	30	18	CU2030RE18	1,014	1,614	3,919	1,471	1,894	4,375
			20	CU2030RE20	1,082	1,682	3,986	1,564	1,988	4,468
	24	36	16	CU2436RE16	1,125	1,920	5,092	1,590	2,013	5,557
			18	CU2436RE18	1,200	1,995	5,167	1,691	2,114	5,657
	24	48	16	CU2448RE16	1,290	2,321	5,825	1,810	2,233	6,343
			18	CU2448RE18	1,373	2,402	5,907	1,918	2,342	6,453

How to Order

Table Model Number

CU Base Series	2020 Top Size	SQ Top Shape	18 Table Height	COVEN Material	CDW Designer White	WNM Natural Maple Veneer
--------------------------	-------------------------	------------------------	---------------------------	--------------------------	------------------------------	------------------------------------

A CU2020SQ18COVENWNM is a cube occasional table, 20" x 20" square x 18" high with wood veneer base and corian top.

The code: CDW specifies Designer White corian top with wood natural maple veneer base.

Options

KBL Laminate Kick Base	LJB Jett Black
----------------------------------	--------------------------

The code: KBL specifies a 2" high x 1" deep laminate kick base.

The code: LJB specifies the color of the laminate used on the kick base.

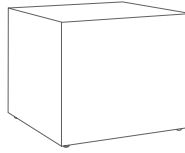

Options

Base Options

Kick Base (laminated)	KBL	319
Kick Base (veneer)	KBV	414

Top Materials and Finishes

Any non-standard WCI Laminates (set-up charge)	use manufacturers finish code	165
Standard Wood Veneer	use wood surface code	n/c
Premium Laminates	PL	📞
Custom Wood Veneer	CWV	📞
Custom Top Material	NSF	📞
Special Pattern Veneer	SPV	📞
Stain to Match (set-up charge)	STM	476

📞 Call for pricing

844.815.2217

CYLINDER – Occasional

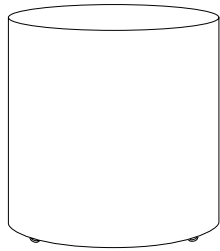

Laminate	Overlay		Wood	Overlay	
Laminate	Corian®	Okite® Q2	Veneer	Corian®	Okite® Q2
LAM Laminate	COLAM Corian® Top	QOLAM Okite® Quartz Top (Q2)	VEN Wood Veneer	COVEN Corian® Top	QOVEN Okite® Quartz Top (Q2)

Complete Table List Pricing

	Top Size	Table Height	Model #						
Round 	18	18	CY18RD18	908	1,315	2,679	1,069	1,475	2,840
		20	CY18RD20	1,074	1,530	3,058	1,265	1,722	3,248
		24	CY18RD24	1,172	1,628	3,155	1,366	1,821	3,350
	20	18	CY20RD18	1,067	1,571	3,121	1,260	1,764	3,314
		20	CY20RD20	1,130	1,634	3,183	1,332	1,836	3,386
		24	CY20RD24	1,234	1,738	3,288	1,437	1,939	3,491
	24	18	CY24RD18	1,133	1,752	3,542	1,367	1,987	3,776
		20	CY24RD20	1,200	1,821	3,609	1,442	2,061	3,851
		24	CY24RD24	1,315	1,935	3,724	1,553	2,174	3,961
	30	16	CY30RD16	1,400	2,269	4,304	1,649	2,519	4,554
		18	CY30RD18	1,489	2,361	4,393	1,745	2,614	4,649
		20	CY30RD20	1,580	2,450	4,485	1,839	2,709	4,743
24		CY30RD24	1,740	2,609	4,644	1,989	2,859	4,894	
36	18	CY36RD18	1,624	2,927	5,590	1,870	3,174	5,838	
	20	CY36RD20	1,726	3,029	5,693	1,973	3,278	5,941	
	24	CY36RD24	1,912	3,216	5,878	2,145	3,449	6,112	

How to Order

Table Model Number

CY Base Series	24 Top Size	RD Top Shape	18 Table Height	COVEN Material	CDW Designer White	WNM Base Material
-------------------	----------------	-----------------	--------------------	-------------------	-----------------------	----------------------

A CY24RD18CVENCDDWWNM is a cylinder occasional table, 24" round x 18" high in wood veneer with corian top.

Options

KBL Laminate Kick Base	LJB Jett Black
---------------------------	-------------------

The code: KB specifies a 2" high x 1" deep laminate kick base.

The code: CDW specifies Designer White corian top with wood natural maple veneer base.

The code: LJB specifies the color of the laminate used on the kick base.

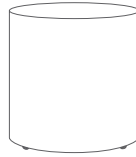

Options

Base Options

Kick Base (laminated)	KBL	319
Kick Base (veneer)	KBV	414

Top Materials and Finishes

Any non-standard WCI Laminates (set-up charge)	use manufacturers finish code	165
Standard Wood Veneer	use wood surface code	n/c
Premium Laminates	PL	📞
Custom Wood Veneer	CWV	📞
Custom Top Material	NSF	📞
Special Pattern Veneer	SPV	📞
Stain to Match (set-up charge)	STM	476

📞 Call for pricing

844.815.2217

DISC – Occasional

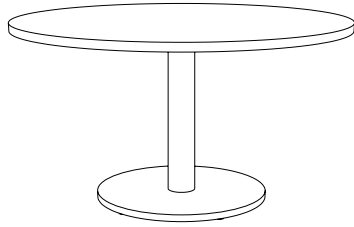

Laminate Surface		Wood Surface		Solid Surface	
LMFC Mini Facet Ply	LFCT Facet Ply	WMFC Mini Facet Ply	WFCT Facet Ply	COFM Mini Facet	COFC Facet

Complete Table List Pricing

	Top Size	Table Height	Base Qty.	Model #							
Round 	20	16	1	DI20RD16	1,267	-	1,283	-	1,576	-	
	20	18	1	DI20RD18	1,267	-	1,283	-	1,576	-	
	20	20	1	DI20RD20	1,267	-	1,283	-	1,576	-	
	24	16	1	DI24RD16	-	1,373	-	1,389	-	1,744	
	24	18	1	DI24RD18	-	1,373	-	1,389	-	1,744	
	24	20	1	DI24RD20	-	1,373	-	1,389	-	1,744	
	30	16	1	DI30RD16	-	1,553	-	1,569	-	2,143	
	30	18	1	DI30RD18	-	1,553	-	1,569	-	2,143	
	36	16	1	DI36RD16	-	2,010	-	2,068	-	2,950	
	36	18	1	DI36RD18	-	2,010	-	2,068	-	2,950	
	42	16	1	DI42RD16	-	2,211	-	2,361	-	3,537	
	42	18	1	DI42RD18	-	2,211	-	2,361	-	3,537	
						-	-	-	-	-	-

How to Order

Table Model Number

DI Table Series	17 Top Size	RD Top Shape	18 Table Height	WMFC Top Material	WNM Top Finish	MBM Base Finish	WNM Wood Column Finish
--------------------	----------------	-----------------	--------------------	----------------------	-------------------	--------------------	---------------------------

A DI17RD18WMFCWNMMBMWNM is a Kone series 17" round x 18" high occasional table with a black powder coat base and a wood veneer top .5" thick top with a .5" facet wood edge profile.

The code: WNM specifies a natural maple top.

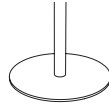

Options

Base Finishes

Custom Powder Coat (set-up charge)	CPC	📞
Polished or Satin Chrome (per column)	use finish code	660
Premium Plated (per base)	use finish code	1,430
Stainless Steel Column and Base Cover (per base)	use finish code	1,650

Top Materials and Finishes

Any non-standard WCI Laminates (set-up charge)	use manufacturers finish code	165
Premium Laminates	PL	📞
Custom Wood Veneer	CWV	📞
Stain to Match (set-up charge)	STM	476

Top Options

Custom Size	CS	📞
-------------	----	---

📞 Call for pricing

844.815.2217

KONE – Occasional

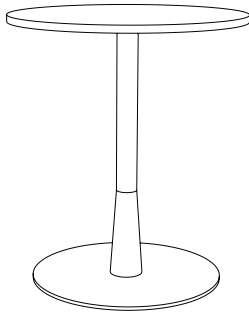

Laminate Surface Wood Surface Solid Surface

Laminate		Veneer		Corian®	
LMFC Mini Facet Ply	LFCT Facet Ply	WMFC Mini Facet Ply	WFCT Facet Ply	COFM Mini Facet	COFC Facet

Complete Table List Pricing

	Top Size	Table Height	Base Qty.	Model #	Laminate	Wood	Solid
Round 	17	16	1	KO17RD16	1,484	-	1,597
		18	1	KO17RD18	1,484	-	1,597
		20	1	KO17RD20	1,484	-	1,597
	20	16	1	KO20RD16	1,566	-	1,649
		18	1	KO20RD18	1,566	-	1,649
		20	1	KO20RD20	1,566	-	1,649
	24	16	1	KO24RD16	-	2,042	2,056
		18	1	KO24RD18	-	2,042	2,056
		20	1	KO24RD20	-	2,042	2,056
	30	16	1	KO30RD16	-	2,218	2,218
		18	1	KO30RD18	-	2,218	2,218
		20	1	KO30RD20	-	2,218	2,218
36	16	1	KO36RD16	-	2,665	2,705	
	18	1	KO36RD18	-	2,665	2,705	
	20	1	KO36RD20	-	2,665	2,705	
42	16	1	KO42RD16	-	2,846	2,991	
	18	1	KO42RD18	-	2,846	2,991	
	20	1	KO42RD20	-	2,846	2,991	

How to Order

Table Model Number

KO Table Series	17 Top Size	RD Top Shape	18 Table Height	WMFC Top Material	WNM Top Finish	MBM Base Finish	WNM Wood Column Finish
---------------------------	-----------------------	------------------------	---------------------------	-----------------------------	--------------------------	---------------------------	----------------------------------

A KO17RD18WMFCWNMMBMWNM is a Kone series 17" round x 18" high occasional table with a black powder coat base and a wood veneer top .5" thick top with a .5" facet wood edge profile.

The code: WNM specifies a natural maple top.

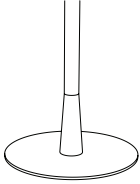





Options

Base Finishes			
Custom Powder Coat (set-up charge)	CPC		📞
Polished or Satin Chrome (per column)	use finish code	660	
Premium Plated (per base)	use finish code	1,430	
Stainless Steel Column and Base Cover (per base)	use finish code	1,650	
Top Materials and Finishes			
Any non-standard WCI Laminates (set-up charge)	use manufacturers finish code	165	
Premium Laminates	PL		📞
Custom Wood Veneer	CWV		📞
Stain to Match (set-up charge)	STM	476	
Top Options			
Custom Size	CS		📞

📞 Call for pricing

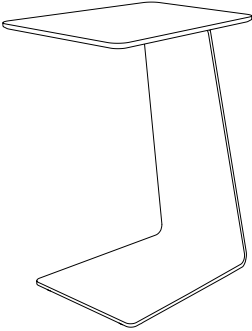
844.815.2217

MOVE – Occasional

	Laminate Surface		Solid Surface
	Laminate	Veneer	Corian®
	 LMOV Ply	 WMOV Wood	

Complete Table List Pricing

	Top Size		Table Height		Model #	1,096	1,210	1,242
	18	13	15	25				
Trapezoid					MOV			
								

How to Order

Table Model Number

MOV Table Series	WMOV Top Material	WNM Top Finish	MBM Base Finish
----------------------------	-----------------------------	--------------------------	---------------------------

A MOVWMOVWNMBM is a Move table with a matte black powder coat base and a wood veneer top.

The code: WNM specifies a natural maple top.

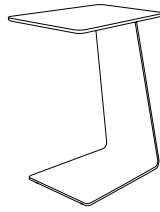

Options

Base Finishes

Custom Powder Coat (set-up charge)	CPC	📞
Satin Chrome (per base)	use finish code	523
Premium Plated (per base)*	use finish code	1,430

*Premium plated polished not available on Move tables.

Top Materials and Finishes

Any non-standard WCI Laminates (set-up charge)	use manufacturers finish code	165
Premium Laminates	PL	📞
Custom Wood Veneer	CWV	📞
Stain to Match (set-up charge)	STM	476

Top Options

Handle**	HAN	99
Cup holder Left	CHL	99
Cup Holder Right	CHR	99
Bag Hook Left	BHL	72
Bag Hook Right	BHR	72

**Handle available for Corian®.

📞 Call for pricing

844.815.2217

PARSONS – Occasional

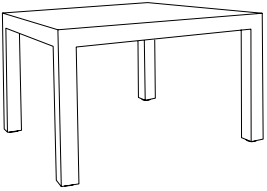
	Laminate	Wood
	Laminate LAM Laminate	Veneer VEN Wood Veneer

Complete Table List Pricing

	Top Size		Table Height	Model #	Laminate	Wood
Square 	18	18	18	PA1818SQ18	1,636	2,360
			20	PA1818SQ20	1,670	2,395
			24	PA1818SQ24	1,738	2,464
	20	20	18	PA2020SQ18	1,669	2,405
			20	PA2020SQ20	1,703	2,440
			24	PA2020SQ24	1,772	2,509
	24	24	18	PA2424SQ18	1,959	2,752
			20	PA2424SQ20	1,993	2,787
			24	PA2424SQ24	2,061	2,858
	30	30	16	PA3030SQ16	2,105	3,010
			18	PA3030SQ18	2,166	3,099
			20	PA3030SQ20	2,200	3,134
24			PA3030SQ24	2,269	3,204	
36	36	16	PA3636SQ16	2,317	3,299	
		18	PA3636SQ18	2,376	3,388	
		20	PA3636SQ20	2,411	3,423	
		24	PA3636SQ24	2,479	3,494	

Continued on next page

How to Order

Table Model Number

PA	1818	SQ	18	VEN	WNM
Base Series	Top Size	Top Shape	Table Height	Material	Wood Natural Maple Veneer

A PA1818SQ18VENWNM is a Parsons series 18" x 18" square x 18" high occasional table, with four with wood veneer legs.

The code: WNM specifies wood natural maple veneer.

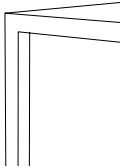

Options

Top Materials and Finishes		
Any non-standard WCI Laminates (set-up charge)	use manufacturers finish code	165
Premium Laminates	PL	📞
Custom Wood Veneer	CWV	📞
Special Pattern Veneer	SPV	📞
Stain to Match (set-up charge)	STM	476

📞 Call for pricing

844.815.2217

PARSONS – Occasional

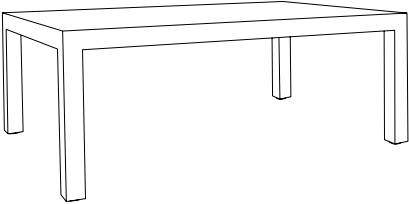
	Laminate	Wood
	Laminate LAM Laminate	Veneer VEN Wood Veneer

Complete Table List Pricing

	Top Size		Table Height	Model #		
Rectangle 	18	36	16	PA1836RE16	1,829	2,715
			18	PA1836RE18	1,890	2,804
			20	PA1836RE20	1,924	2,838
	18	48	16	PA1848RE16	2,031	2,991
			18	PA1848RE18	2,091	3,080
			20	PA1848RE20	2,125	3,115
	18	60	16	PA1860RE16	2,220	3,260
			18	PA1860RE18	2,279	3,350
			20	PA1860RE20	2,314	3,385
	20	30	16	PA2030RE16	1,803	2,681
			18	PA2030RE18	1,863	2,770
			20	PA2030RE20	1,898	3,064
24	36	16	PA2436RE16	2,009	2,969	
		18	PA2436RE18	2,069	3,084	
24	48	16	PA2448RE16	2,192	3,242	
		18	PA2448RE18	2,252	3,331	

How to Order

Table Model Number

PA	1860	RE	18	VEN	WNM
Base Series	Top Size	Top Shape	Table Height	Material	Wood Natural Maple Veneer

A PA1860RE18VENWNM is a Parsons series 18" x 60" rectangle x 18" high occasional table, with four wood veneer legs.

The code: WNM specifies wood natural maple veneer.

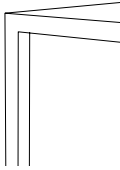

Options

Top Materials and Finishes

Any non-standard WCI Laminates (set-up charge)	use manufacturers finish code	165
Premium Laminates	PL	📞
Custom Wood Veneer	CWV	📞
Special Pattern Veneer	SPV	📞
Stain to Match (set-up charge)	STM	476

📞 Call for pricing

844.815.2217

PLATFORM – Occasional

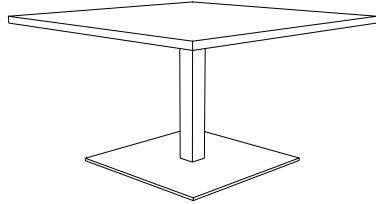

Laminate Surface Wood Surface Solid Surface

Laminate		Veneer		Corian®	
LMFC Mini Facet Ply	LFCT Facet Ply	WMFC Mini Facet Ply	WFCT Facet Ply	COFM Mini Facet	COFC Facet

Complete Table List Pricing

	Top Size		Table Height	Base Qty.	Model #						
Square 	20	20	16	1	PL2020SQ16	988	1,267	1,495	1,249	1,561	-
			18	1	PL2020SQ18	988	1,267	1,495	1,249	1,561	-
			20	1	PL2020SQ20	988	1,267	1,495	1,249	1,561	-
	24	24	16	1	PL2424SQ16	1,043	1,373	1,641	1,388	1,757	2,015
			18	1	PL2424SQ18	1,043	1,373	1,641	1,388	1,757	2,015
			20	1	PL2424SQ20	1,043	1,373	1,641	1,388	1,757	2,015
	30	30	16	1	PL3030SQ16	1,139	1,553	1,840	1,553	1,979	2,749
			18	1	PL3030SQ18	1,139	1,553	1,840	1,553	1,979	2,749
	36	36	16	1	PL3636SQ16	1,538	2,010	2,360	2,068	2,527	3,760
			18	1	PL3636SQ18	1,538	2,010	2,360	2,068	2,527	3,760
	42	42	16	1	PL4242SQ16	1,679	2,211	2,621	2,360	2,822	4,799
			18	1	PL4242SQ18	1,679	2,211	2,621	2,360	2,822	4,799
Rectangle 	20	30	16	1	PL2030RE16	1,033	1,287	1,671	1,357	1,790	-
			18	1	PL2030RE18	1,033	1,287	1,671	1,357	1,790	-
	20	36	16	1	PL2036RE16	1,058	1,346	1,749	1,422	1,877	-
			18	1	PL2036RE18	1,058	1,346	1,749	1,422	1,877	-
	30	36	16	1	PL3036RE16	1,478	1,927	2,242	2,043	2,396	3,428
			18	1	PL3036RE18	1,478	1,927	2,242	2,043	2,396	3,428
	30	42	16	1	PL3042RE16	1,536	2,078	2,432	2,210	2,608	3,815
			18	1	PL3042RE18	1,536	2,078	2,432	2,210	2,608	3,815
	30	48	16	1	PL3048RE16	1,806	2,363	2,747	2,507	2,937	4,424
			18	1	PL3048RE18	1,806	2,363	2,747	2,507	2,937	4,424

How to Order

Table Model Number

PL	1717	SQ	18	WMFC	WNM	MBM	WNM
Table Series	Top Size	Top Shape	Table Height	Top Material	Top Finish	Base Finish	Wood Column Finish

A PL1717SQ18WMFCWNM is a Blok series 17" x 17" square x 18" high occasional table with a black powder coat base and a wood veneer top .5" thick top with a .5" facet wood edge profile.

The code: WNM specifies a natural maple top.

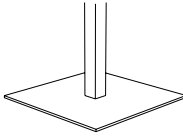

Options

Base Finishes

Custom Powder Coat (set-up charge)	CPC	📞
Polished or Satin Chrome (per column)	use finish code	660
Premium Plated (per base)	use finish code	1,430
Stainless Steel Column and Base Cover (per base)	use finish code	1,650

Top Materials and Finishes

Any non-standard WCI Laminates (set-up charge)	use manufacturers finish code	165
Premium Laminates	PL	📞
Custom Wood Veneer	CWV	📞
Stain to Match (set-up charge)	STM	476

Top Options

Custom Size	CS	📞
-------------	----	---



📞 Call for pricing

844.815.2217

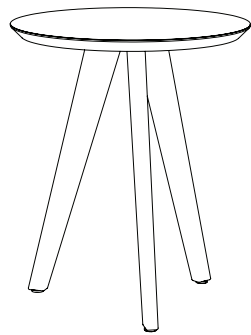
TRIAD – Occasional



Wood Solid Surface

Veneer	Corian®
	
WWTR Prism	CoPR Prism

Complete Table List Pricing

	Top Size	Table Height	Base Qty.	Model #		
Round 	20	18	1	TR20RD18	1,613	1,805
		20	1	TR20RD20	1,683	2,082
	24	16	1	TR24RD16	1,752	2,152
		18	1	TR24RD18	1,824	2,222
		20	1	TR24RD20	1,893	2,291
	30	16	1	TR30RD16	2,104	2,430
	36	16	1	TR36RD16	2,329	2,720

How to Order

Table Model Number

TR	20RD	18	WTTR	WNA
Table Series	Top Size	Table Height	Top Material	Top Finish

A TR20RD18WWTRWNAWNA is a 20" round x 18"H Triad occasional table with a wood veneer top and base.

The code: WNA specifies a natural Ash top.

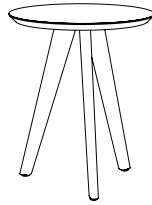

Options

Top Materials and Finishes

Custom Wood Veneer	CWV	📞
Custom Top Pattern	NSF	📞
Stain to Match (set-up charge)	STM	476

📞 Call for pricing

844.815.2217

Outdoor Tables

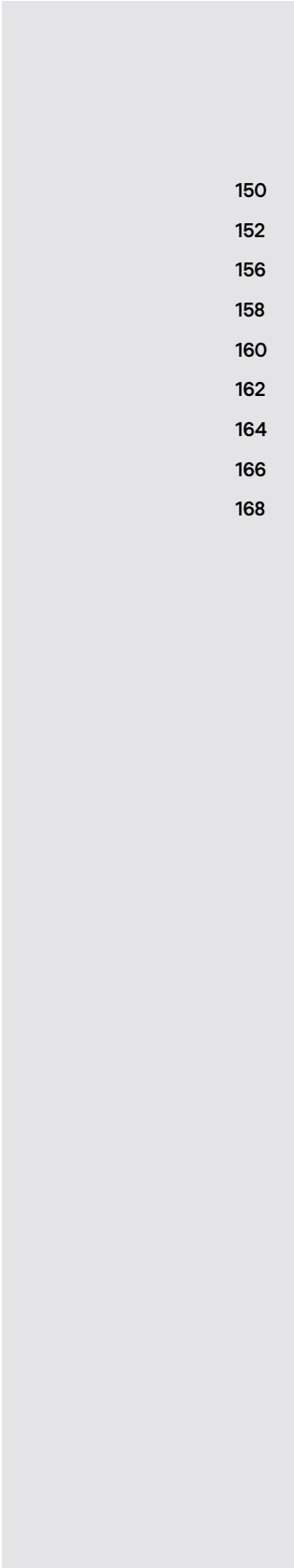



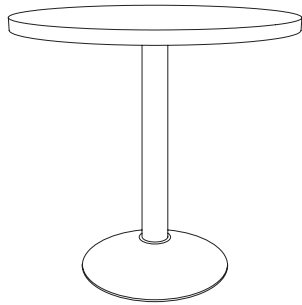

- 150 Basic Round
- 152 Brae
- 156 Brae Double
- 158 Disc
- 160 Flat Round
- 162 Platform
- 164 Platform Double
- 166 Tulip
- 168 Vista



BASIC ROUND – Outdoor



Metal Surface Solid Surface

Metal Surface		Solid Surface
Metal Solid	Metal Mesh	Corian®
 MES Solid	 MEM Mesh	 COFL Flat
		 COBN Bullnose

Complete Table List Pricing

	Top Size	Base Qty.	Base Style	Model #			
Round 	24	1	17L	BA24RDOD	-	-	1,477
	30	1	17M	BA30RDOD	1,362	-	1,967
	36	1	20M	BA36RDOD	1,565	-	2,572
	42	1	22L	BA42RDOD	1,733	-	3,187
	48	1	22M	BA48RDOD	1,959	-	3,956
	54	1	22M	BA54RDOD	-	-	4,788
	60	1	28H	BA60RDOD	-	-	5,897
Square 	24 24	1	17L	BA2424SQOD	-	-	1,343
	30 30	1	17M	BA3030SQOD	1,359	-	1,797
	36 36	1	20M	BA3636SQOD	1,536	-	2,385
	42 42	1	22M	BA4242SQOD	1,791	-	3,025
	48 48	1	22M	BA4848SQOD	-	-	3,773
Rectangle 	24 30	1	17M	BA2430REOD	1,244	-	1,583
	24 36	1	20M	BA2436REOD	-	-	1,815
	24 60	2	17L	BA2460REOD	-	-	2,797
	30 36	1	20M	BA3036REOD	-	-	2,075
	30 42	1	22L	BA3042REOD	-	-	2,286
	30 48	1	22M	BA3048REOD	1,691	-	2,589
	30 60	2	17M	BA3060REOD	-	-	3,335

How to Order

Table Model Number

BA Base Series	36 Top Size	RD Top Shape	OD Outdoor	MES Top Material	MSL Top Finish	MBM Base Finish
--------------------------	-----------------------	------------------------	----------------------	----------------------------	--------------------------	---------------------------

A BA36RDODMESMSLMBM is an outdoor Basic Round series 36" round table with a black powder coat round base and a solid metal .75" thick top with a metal eased edge profile.

The code: MSL specifies a silver powder coat top.

Options

AH Alternate Height Base

The code: AH specifies alternate height base

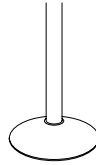

Options

Base Finishes

Standard Black Texture	MBT	n/c
Powder Coat	use finish code	128
Custom Powder Coat (set-up charge)	CPC	📞

Base Options

Counter, Bar, & Alternate Height (per column)	CH, BH, AH	76
Super Level Glides (per base)	GSL	n/c
Custom Top Plate Size	CTPS	📞
6" Column (black texture & powder coat)	COL6	224







Top Options

3" Radius Corner (per corner) (Corian®)	CRL3	40
Custom Radius Corner	CRC	95
Custom Size	CS	📞
Custom Shape	CSH	📞
2" Umbrella Hole	UMB	286

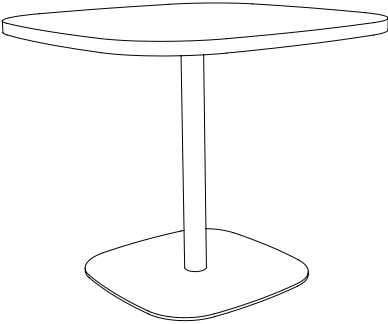

📞 Call for pricing

844.815.2217

BRAE – Outdoor

	Metal Surface	Solid Surface
	Metal Solid  MES Solid	Metal Mesh  MEM Mesh
	Corian®  COFL Flat	
	 COBN Bullnose 	

Complete Table List Pricing

	Top Size	Base Qty.	Model #			
Round 	30	1	BR3ORDOD	1,815	-	2,420
	36	1	BR36RDOD	2,253	-	3,258
	42	1	BR42RDOD	2,428	-	3,882
	48	1	BR48RDOD	2,815	-	4,810
RD Square 	30 30	1	BR3030RSOD	-	-	2,252
	36 36	1	BR3636RSOD	-	-	3,071
	42 42	1	BR4242RSOD	-	-	3,659
	48 48	1	BR4848RSOD	-	-	4,567
Square 	30 30	1	BR3030SQOD	1,812	-	2,252
	36 36	1	BR3636SQOD	2,223	-	3,071
	42 42	1	BR4242SQOD	2,423	-	3,659
	48 48	1	BR4848SQOD	-	-	4,567

Continued on next page

How to Order

Table Model Number							Options
BR Base Series	36 Top Size	RD Top Shape	OD Outdoor	MES Top Material	MBM Top Finish	MSL Base Finish	AH Alternate Height Base
A BR36RDODMESMBMMSL is an outdoor Brae series 36" round table with a silver powder coat base and a metal .75" thick top with a metal eased edge profile.					The code: MBM specifies a black matte powder coat top.		The code: AH specifies alternate height base

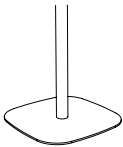







Options

Base Finishes		
Custom Powder Coat (set-up charge)	CPC	📞
Stainless Steel (per base)	use finish code	1,650
Base Options		
Counter, Bar, & Alternate Height (per column)	CH, BH, AH	76
Custom Top Plate Size	CTPS	📞
6" Column (powder coat)	COL6	📞
Top Options		
3" Radius Corner (per corner)	CRL3	40
(Corian®) Custom Size	CS	📞
Custom Radius Corner	CRC	95
Custom Shape	CSH	📞
Standard Powder Coat	use finish code	n/c
2" Umbrella Hole	UMB	286

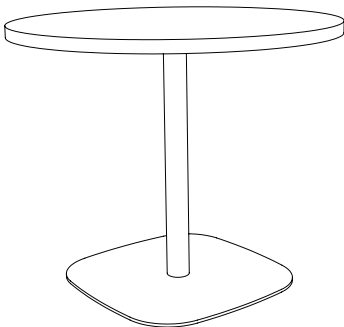

📞 Call for pricing

844.815.2217

BRAE – Outdoor

	Metal Surface	Solid Surface
	Metal Solid  MES Solid	Metal Mesh  MEM Mesh
	Corian®  COFL Flat  COBN Bullnose 	

Complete Table List Pricing

	Top Size	Base Qty.	Model #			
Rectangle 	24 30	1	BR2430REOD	1,697	-	2,035
	24 36	1	BR2436REOD	-	-	2,503
	24 42	1	BR2442REOD	-	-	2,680
	24 48	1	BR2448REOD	-	-	2,859
	24 60	2	BR2460REOD	-	-	3,814
	24 72	2	BR2472REOD	-	-	4,193
	30 36	1	BR3036REOD	-	-	2,761
	30 42	1	BR3042REOD	-	-	2,980
	30 48	1	BR3048REOD	2,547	-	3,446
	30 60	2	BR3060REOD	-	-	4,242
RD Rectangle 	30 48	1	BR3048RRD	-	-	3,446
	30 60	2	BR3060RRD	-	-	4,242

How to Order

Table Model Number							Options
BR Base Series	36 Top Size	RD Top Shape	OD Outdoor	MES Top Material	MBM Top Finish	MSL Base Finish	AH Alternate Height Base
A BR36RDODMESMBMMSL is an outdoor Brae series 36" round table with a silver powder coat base and a metal .75" thick top with a metal eased edge profile.					The code: MBM specifies a black matte powder coat top.		The code: AH specifies alternate height base

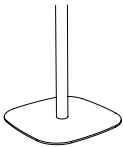

Options

Base Finishes		
Custom Powder Coat (set-up charge)	CPC	📞
Stainless Steel (per base)	use finish code	1,650

Base Options		
Counter, Bar, & Alternate Height (per column)	CH, BH, AH	76
Custom Top Plate Size	CTPS	📞
6" Column (powder coat)	COL6	📞









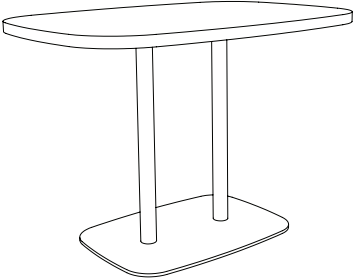





Top Options		
3" Radius Corner (per corner)	CRL3	40
(Corian®) Custom Size	CS	📞
Custom Radius Corner	CRC	95
Custom Shape	CSH	📞
Standard Powder Coat	use finish code	n/c
2" Umbrella Hole	UMB	286

📞 Call for pricing



844.815.2217

BRAE DOUBLE – Outdoor



Metal Surface		Solid Surface							
<table style="width: 100%; border-collapse: collapse;"> <tr> <td style="text-align: center; border-bottom: 1px solid black;">Metal Solid</td> <td style="text-align: center; border-bottom: 1px solid black;">Metal Mesh</td> </tr> <tr> <td style="text-align: center;">  MES Solid </td> <td style="text-align: center;">  MEM Mesh </td> </tr> </table>	Metal Solid	Metal Mesh	 MES Solid	 MEM Mesh	<table style="width: 100%; border-collapse: collapse;"> <tr> <td style="text-align: center; border-bottom: 1px solid black;">Corian®</td> </tr> <tr> <td style="text-align: center;">  COFL Flat </td> </tr> <tr> <td style="text-align: center;">  COBN Bullnose </td> </tr> <tr> <td style="text-align: center;">  </td> </tr> </table>	Corian®	 COFL Flat	 COBN Bullnose	
Metal Solid	Metal Mesh								
 MES Solid	 MEM Mesh								
Corian®									
 COFL Flat									
 COBN Bullnose									
									

Complete Table List Pricing

	Top Size		Base Qty.	Model #			
Rectangle 	30	42	1	BRD3042REOD	-	-	3,323
	30	48	1	BRD3048REOD	2,666	-	3,566
RD Rectangle 	30	42	1	BRD3042RRD	-	-	3,323
	30	48	1	BRD3048RRD	-	-	3,566

How to Order

Table Model Number							Options
BRD Base Series	3048 Top Size	RE Top Shape	OD Outdoor	MES Top Material	MBM Top Finish	MSL Base Finish	AH Alternate Height Base
<p>A BRD3048REODMESMBMMSL is a Brae Double series 30" x 48" rectangle table with a silver powder coat base and a solid metal .75" thick top with a metal eased edge profile.</p>					<p>The code: MBM specifies a black matte powder coat top.</p>		<p>The code: AH specifies alternate height base</p>

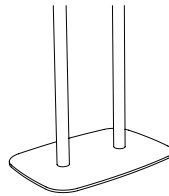

Double Column Base

Options

Base Finishes

Custom Powder Coat (set-up charge)	CPC	📞
Stainless Steel (per base)	use finish code	1,650

Base Options

Counter, Bar, & Alternate Height (per column)	CH, BH, AH	76
Custom Top Plate Size	CTPS	📞
6" Column (powder coat)	COL6	📞





Top Options

3" Radius Corner (per corner)	CRL3	40
(Corian®) Custom Size	CS	📞
Custom Radius Corner	CRC	95
Custom Size	CS	📞
Custom Shape	CSH	📞
2" Umbrella Hole	UMB	286

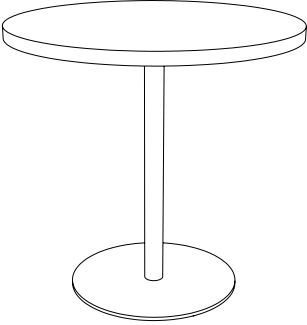

📞 Call for pricing

844.815.2217

DISC – Outdoor

	Metal Surface	Solid Surface
	Metal Solid  MES Solid	Metal Mesh  MEM Mesh
		Corian®  COFL Flat
		 COBN Bullnose

Complete Table List Pricing

	Top Size	Base Qty.	Model #			
Round 	24	1	DI24RDOD	-	-	1,987
	30	1	DI30RDOD	1,815	-	2,420
	36	1	DI36RDOD	2,253	-	3,258
	42	1	DI42RDOD	2,428	-	3,882
	48	1	DI48RDOD	2,815	-	4,810
	54	1	DI54RDOD	-	-	5,583
	60	1	DI60RDOD	-	-	6,459
Square 	24 24	1	DI2424SQOD	-	-	1,852
	30 30	1	DI3030SQOD	1,812	-	2,252
	36 36	1	DI3636SQOD	2,223	-	3,071
	42 42	1	DI4242SQOD	2,423	-	3,659
	48 48	1	DI4848SQOD	-	-	4,567
Rectangle 	24 30	1	DI2430REOD	1,697	-	2,035
	24 36	1	DI2436REOD	-	-	2,503
	24 42	1	DI2442REOD	-	-	2,680
	24 48	1	DI2448REOD	-	-	2,859
	24 60	2	DI2460REOD	-	-	3,814
	24 72	2	DI2472REOD	-	-	4,193
	30 36	1	DI3036REOD	-	-	2,761
	30 42	1	DI3042REOD	-	-	2,980
	30 48	1	DI3048REOD	2,547	-	3,446
	30 60	2	DI3060REOD	-	-	4,242
	30 72	2	DI3072REOD	-	-	4,698
	36 42	1	DI3642REOD	-	-	3,585
	36 48	1	DI3648REOD	-	-	4,330
	36 60	2	DI3660REOD	-	-	5,279
	36 72	2	DI3672REOD	-	-	5,800
	36 84	2	DI3684REOD	-	-	-
36 96	2	DI3696REOD	-	-	-	

How to Order

Table Model Number							Options
DI Base Series	36 Top Size	RD Top Shape	OD Outdoor	MES Top Material	MBM Top Finish	MSL Base Finish	AH Alternate Height Base
A DI36RDODMESMBMMSL is an outdoor Disc series 36" round table with a silver powder coat round base and a metal .75" thick top with a metal eased edge profile.					The code: MBM specifies a black matte powder coat top.		The code: AH specifies alternate height base.

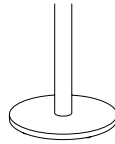

Options

Base Finishes

Custom Powder Coat (set-up charge)	CPC	📞
Stainless Steel (per base)	use finish code	1,650

Base Options

Counter, Bar, & Alternate Height (per column)	CH, BH, AH	76
Custom Top Plate Size	CTPS	📞
6" Column (powder coat)	COL6	📞

Top Options

3" Radius Corner (per corner)	CRL3	40
(Corian®) Custom Size	CS	📞
Custom Radius Corner	CRC	95
Custom Shape	CSH	📞
Standard Powder Coat	use finish code	n/c
2" Umbrella Hole	UMB	286



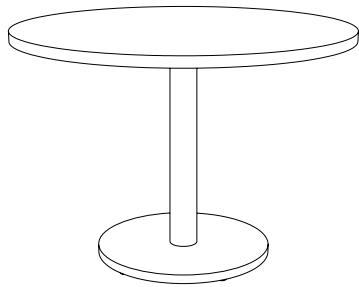

📞 Call for pricing

844.815.2217



FLAT ROUND – Outdoor



Metal Surface Solid Surface

Metal Surface		Solid Surface
Metal Solid	Metal Mesh	Corian®
		
MES Solid	MEM Mesh	COFL Flat
		
		COBN Bullnose
		

Complete Table List Pricing

	Top Size	Base Qty.	Model #			
Round 	24	1	FR24RDOD	-	-	1,871
	30	1	FR30RDOD	1,701	-	2,305
	36	1	FR36RDOD	2,066	-	3,071
	42	1	FR42RDOD	2,241	-	3,695
	48	1	FR48RDOD	2,405	-	4,401
	54	1	FR54RDOD	-	-	5,352
	60	1	FR60RDOD	-	-	6,227
Square 	24 24	1	FR2424SQOD	-	-	1,737
	30 30	1	FR3030SQOD	1,697	-	2,136
	36 36	1	FR3636SQOD	2,035	-	2,884
	42 42	1	FR4242SQOD	2,236	-	3,471
	48 48	1	FR4848SQOD	-	-	4,335
Rectangle 	24 30	1	FR2430REOD	1,582	-	1,921
	24 36	1	FR2436REOD	-	-	2,101
	24 42	1	FR2442REOD	-	-	2,492
	24 48	1	FR2448REOD	-	-	2,672
	24 60	2	FR2460REOD	-	-	3,584
	24 72	2	FR2472REOD	-	-	3,963
	30 36	1	FR3036REOD	-	-	2,360
	30 42	1	FR3042REOD	-	-	2,793
	30 48	1	FR3048REOD	2,136	-	3,036
	30 60	2	FR3060REOD	-	-	4,012
	30 72	2	FR3072REOD	-	-	4,468
	36 42	1	FR3642REOD	-	-	3,398
	36 48	1	FR3648REOD	-	-	3,919
	36 60	2	FR3660REOD	-	-	4,476
	36 72	2	FR3672REOD	-	-	4,997
	36 84	2	FR3684REOD	-	-	-
	36 96	2	FR3696REOD	-	-	-

How to Order

Table Model Number						Options	
FR Base Series	36 Top Size	RD Top Shape	OD Outdoor	AAOP Top Material	AGL Top Finish	MSA Base Finish	AH Alternate Height Base

A FR36RDODAAOPAGLMSA is an outdoor Flat Round series 36" round table with a satin aluminum round base and an opaque acrylic top.

The code: AAOP specifies an acrylic top in Glacier

The code: AH specifies alternate height base

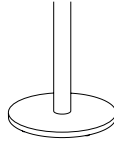

Options

Base Finishes

Custom Powder Coat (set-up charge)	CPC	📞
Stainless Steel (per base)	use finish code	1,650

Base Options

Counter, Bar, & Alternate Height (per column)	CH, BH, & AH	76
Super Level Glides (per base)	GSL	n/c
Custom Top Plate Size	CTPS	📞
6" Column (black texture & powder coat)	COL6	224







Top Options

3" Radius Corner (per corner) (Corian®)	CRL3	40
Custom Radius Corner (per corner)	CRC	95
Custom Size	CS	📞
Custom Shape	CSH	📞
2" Umbrella Hole	UMB	286

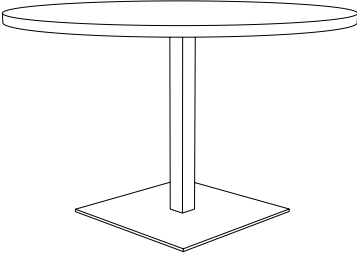

📞 Call for pricing

844.815.2217

PLATFORM – Outdoor

	Metal Surface	Solid Surface
	Metal Solid  MES Solid	Metal Mesh  MEM Mesh
		Corian®  COFL Flat
		 COBN Bullnose 

Complete Table List Pricing

	Top Size	Base Qty.	Model #			
Round 	30	1	PL30RDOD	1,815	-	2,420
	36	1	PL36RDOD	2,253	-	3,258
	48	1	PL48RDOD	2,815	-	4,810
	54	1	PL54RDOD	-	-	5,583
	60	1	PL60RDOD	-	-	6,459
Square 	24 24	1	PL2424SQOD	-	-	1,851
	30 30	1	PL3030SQOD	1,812	-	2,252
	36 36	1	PL3636SQOD	2,223	-	3,071
	42 42	1	PL4242SQOD	2,423	-	3,658
	48 48	1	PL4848SQOD	-	-	4,566
Rectangle 	24 30	1	PL2430REOD	1,697	-	2,036
	24 36	1	PL2436REOD	-	-	2,501
	24 42	1	PL2442REOD	-	-	2,679
	24 48	1	PL2448REOD	-	-	2,859
	24 60	2	PL2460REOD	-	-	3,814
	24 72	2	PL2472REOD	-	-	4,193
	24 84	2	PL2484REOD	-	-	-
	24 96	2	PL2496REOD	-	-	-
	30 36	1	PL3036REOD	-	-	2,761
	30 42	1	PL3042REOD	-	-	2,981
	30 48	1	PL3048REOD	2,545	-	3,445
	30 60	2	PL3060REOD	-	-	4,242

How to Order

Table Model Number							Options
PL Base Series	36 Top Size	RD Top Shape	OD Outdoor	MES Top Material	MBM Top Finish	MSL Base Finish	AH Alternate Height Base
A PL36RDODMESMBMMSL is an outdoor Platform series 36" round table with a silver powder coat square base and a solid metal .75" thick top with a metal eased edge profile.					The code: MBM specifies a black matte powder coat top.		The code: AH specifies alternate height base

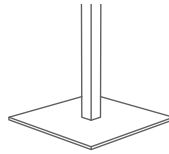

Single Column Base

Options

Base Finishes

Custom Powder Coat (set-up charge)	CPC	📞
Stainless Steel (per base)	use finish code	1,650

Base Options

Counter, Bar, & Alternate Height (per column)	CH, BH, AH	76
Custom Top Plate Size	CTPS	📞
6" Column (powder coat)	COL6	📞

Top Options

3" Radius Corner (per corner)	CRL3	40
(Corian™) Custom Size	CS	📞
Custom Radius Corner	CRC	95
Custom Size	CS	📞
Custom Shape	CSH	📞
Standard Powder Coat	use finish code	n/c
2" Umbrella Hole	UMB	286

📞 Call for pricing

844.815.2217

PLATFORM DOUBLE – Outdoor

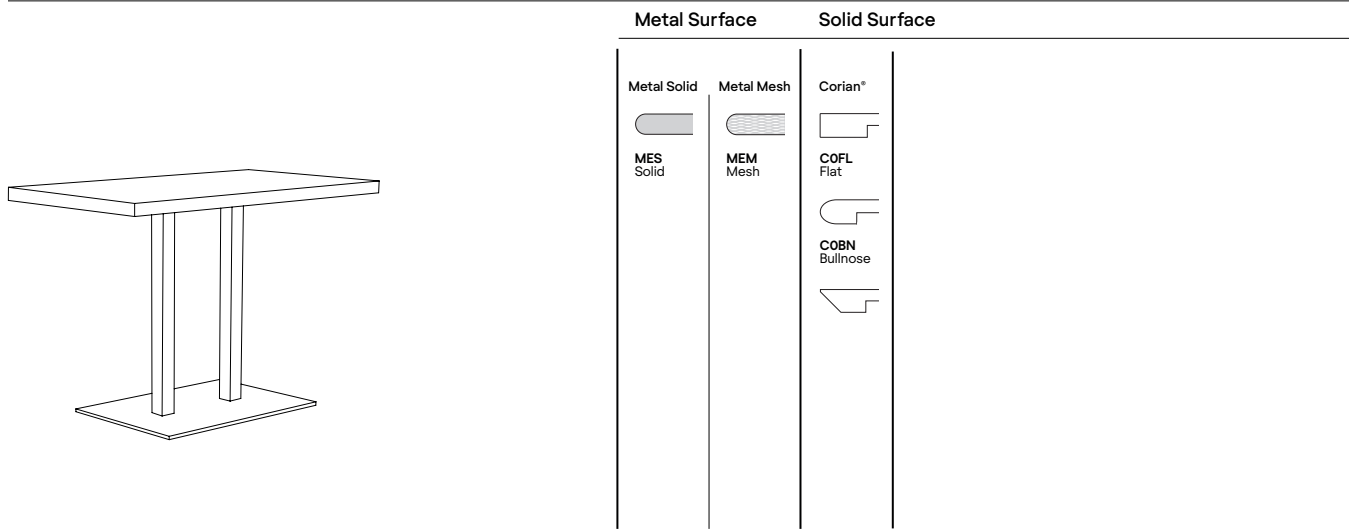

Complete Table List Pricing

	Top Size	Base Qty.	Model #			
Rectangle	30 42	1	PLD3042REOD	-	-	3,323
	30 48	1	PLD3048REOD	2,666	-	3,566

How to Order

Table Model Number							Options
PLD Base Series	3048 Top Size	RE Top Shape	OD Outdoor	MES Top Material	MBM Top Finish	MSL Base Finish	AH Alternate Height Base
A PLD3048REODMESMBMMSL is a Platform Double series 30" x 48" rectangle table with a silver powder coat square base and a solid metal .75" thick top with a metal eased edge profile.					The code: MBM specifies a black matte powder coat top.		The code: AH specifies alternate height base

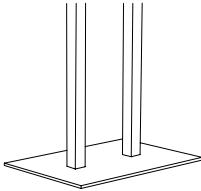

Double Column Base

Options

Base Finishes		
Custom Powder Coat (set-up charge)	CPC	📞
Stainless Steel (per base)	use finish code	1,650
<hr/>		
Base Options		
Counter, Bar, & Alternate Height (per column)	CH, BH, AH	76
Custom Top Plate Size	CTPS	📞
6" Column (powder coat)	COL6	📞
<hr/>		
Top Options		
3" Radius Corner (per corner)	CRL3	40
(Corian®) Custom Size	CS	📞
Custom Radius Corner	CRC	895
Custom Size	CS	📞
Custom Shape	CSH	📞
2" Umbrella Hole	UMB	286



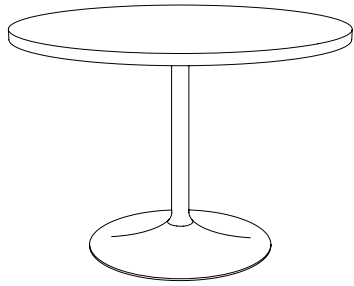

📞 Call for pricing

844.815.2217



TULIP – Outdoor



Metal Surface Solid Surface

Metal Solid	Metal Mesh	Corian®
 MES Solid	 MEM Mesh	 COFL Flat
		 COBN Bullnose
		

Complete Table List Pricing

	Top Size	Base Qty.	Model #			
Round 	24	1	TL24RDOD	-	-	2,166
	30	1	TL30RDOD	2,082	-	2,687
	36	1	TL36RDOD	2,346	-	3,353
	42	1	TL42RDOD	2,583	-	4,038
	48	1	TL48RDOD	2,933	-	4,928
	54	1	TL54RDOD	-	-	5,754
Square 	24 24	1	TL2424SQOD	-	-	2,032
	30 30	1	TL3030SQOD	2,079	-	2,518
	36 36	1	TL3636SQOD	2,317	-	3,165
	42 42	1	TL4242SQOD	2,764	-	3,999
	48 48	1	TL4848SQOD	-	-	4,739
Rectangle 	24 30	1	TL2430REOD	1,965	-	2,303
	24 36	1	TL2436REOD	-	-	2,595
	24 42	1	TL2442REOD	-	-	2,835
	24 48	1	TL2448REOD	-	-	3,199
	24 60	2	TL2460REOD	-	-	4,173
	24 72	2	TL2472REOD	-	-	4,553
	24 84	2	TL2484REOD	-	-	-
	24 96	2	TL2496REOD	-	-	-
	30 36	1	TL3036REOD	-	-	2,855
	30 42	1	TL3042REOD	-	-	3,136
	30 48	1	TL3048REOD	2,663	-	3,563
	30 60	2	TL3060REOD	-	-	4,776

How to Order

Table Model Number

TL18H Base Series	36 Top Size	RD Top Shape	OD Outdoor	MES Top Material	MBM Top Finish	MSL Base Finish
-----------------------------	-----------------------	------------------------	----------------------	----------------------------	--------------------------	---------------------------

A TL18H36RDODMESMBMMSL is an outdoor Tulip series 36" round table with a silver powder coat round base and a solid metal .75" thick top with a metal eased edge profile.

The code: MBM specifies a black matte powder coat top

Options

AH
Alternate Height Base

The code: AH specifies alternate height base

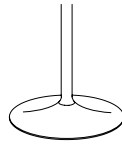

Options

Base Finishes

Custom Powder Coat (set-up charge)	CPC	📞
Stainless Steel (per base)	use finish code	1,650

Base Options

Counter, Bar, & Alternate Height (per column)	CH, BH, AH	76
Custom Top Plate Size	CTPS	📞

Top Options

3" Radius Corner (per corner) (Corian®)	CRL3	40
Custom Radius Corner (per corner)	CRC	95
Custom Size	CS	📞
Custom Shape	CSH	📞

📞 Call for pricing

844.815.2217

VISTA – Outdoor

Solid Surface

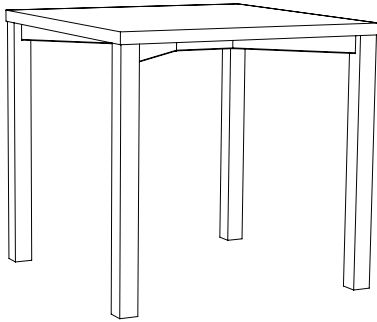



Corian®



COFL

Flat

Complete Table List Pricing

	Top Size		Base Qty.	Model #	
Square 	36	36	1	VS3636SQOD	4,513
	42	42	1	VS4242SQOD	5,031
	48	48	1	VS4848SQOD	6,265
Rectangle 	24	60	1	VS2460REOD	4,101
	24	72	1	VS2472REOD	4,756
	24	84	1	VS2484REOD	5,391
	24	96	1	VS2496REOD	6,007
	24	120	1	VS24120REOD	7,208
	30	60	1	VS3060REOD	5,125
	30	72	1	VS3072REOD	5,594
	30	84	1	VS3084REOD	6,113
	30	96	1	VS3096REOD	6,811
	30	120	1	VS30120REOD	8,174
	36	60	1	VS3660REOD	5,702
	36	72	1	VS3672REOD	6,197
	36	84	1	VS3684REOD	6,466
	36	96	1	VS3696REOD	7,205
	36	120	1	VS36120REOD	8,646
	42	60	1	VS4260REOD	6,727
	42	72	1	VS4272REOD	7,182
	42	84	1	VS4284REOD	8,139
	42	96	1	VS4296REOD	9,071
42	120	1	VS42120REOD	10,885	

How to Order

Table Model Number

VS	3636	SQ	OD	COFL	CDW	MBM
Base Series	Top Size	Top Shape	Outdoor	Top Material Edge Profile	Top Finish	Base Finish

A VS3636SQODCOFLCDWMBM is a Vista series 36" x 36" square table with a black powder coat base and a Corian® top with a flat edge profile.

The code: CDW specifies a Corian® top in designer white.

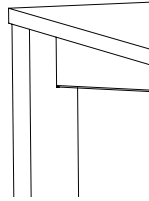

Options

Base Finishes

Custom Powder Coat (set-up charge)	CPC	📞
Stainless Steel (per base)	use finish code	2,310

Base Options

Counter Height	CH	pages 198-199
Bar Height	BH	pages 198-199
Alternative Height	AH	📞

Top Options

2" Umbrella Hole (base provided by other)	UMB	83
---	-----	----

📞 Call for pricing

844.815.2217

VISTA – Outdoor - Counter and Bar Height

Solid Surface

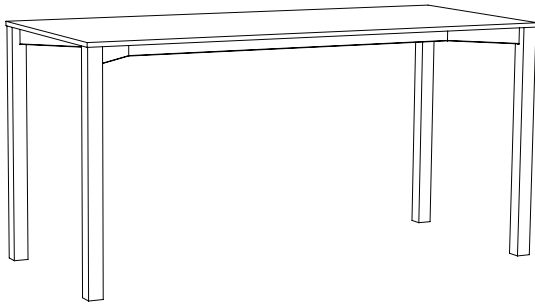



Corian®



COFL
Flat

Complete Table List Pricing

	Top Size	Base Qty.	Model #	
Square 	36 36	1	VS3636SQOD	5,036
	42 42	1	VS4242SQOD	5,556
	48 48	1	VS4848SQOD	6,794
Rectangle 	24 60	1	VS2460REOD	4,622
	24 72	1	VS2472REOD	5,280
	24 84	1	VS2484REOD	5,917
	24 96	1	VS2496REOD	6,535
	24 120	1	VS24120REOD	7,741
	30 60	1	VS3060REOD	5,651
	30 72	1	VS3072REOD	6,119
	30 84	1	VS3084REOD	6,641
	30 96	1	VS3096REOD	7,343
	30 120	1	VS30120REOD	8,710
	36 60	1	VS3660REOD	6,229
	36 72	1	VS3672REOD	6,727
	36 84	1	VS3684REOD	6,996
	36 96	1	VS3696REOD	7,737
	36 120	1	VS36120REOD	9,183
	42 60	1	VS4260REOD	7,257
	42 72	1	VS4272REOD	7,714
	42 84	1	VS4284REOD	8,675
	42 96	1	VS4296REOD	9,609
	42 120	1	VS42120REOD	11,429

How to Order

Table Model Number

VS
Base Series

3636
Top Size

SQ
Top Shape

OD
Outdoor

COFL
Top Material
Edge Profile

A VS3636SQODCOFLCDWMBM-BH is a Vista series 36" x 36" square table with a black powder coat base and a Corian® top with a flat edge profile.

CDW
Top Finish

MBM
Base Finish

The code: CDW specifies a Corian® top in Designer white.

Options

BH
Base Height

The code: BH specifies bar height base.

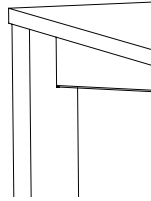

Options

Base Finishes

Custom Powder Coat (set-up charge)	CPC	
Stainless Steel (per base)	use finish code	2,310

Base Options

Counter Height	CH	pages 198-199
Bar Height	BH	pages 198-199
Alternative Height	AH	

Top Options

2" Umbrella Hole (base provided by other)	UMB	83
---	-----	----

 Call for pricing

844.815.2217



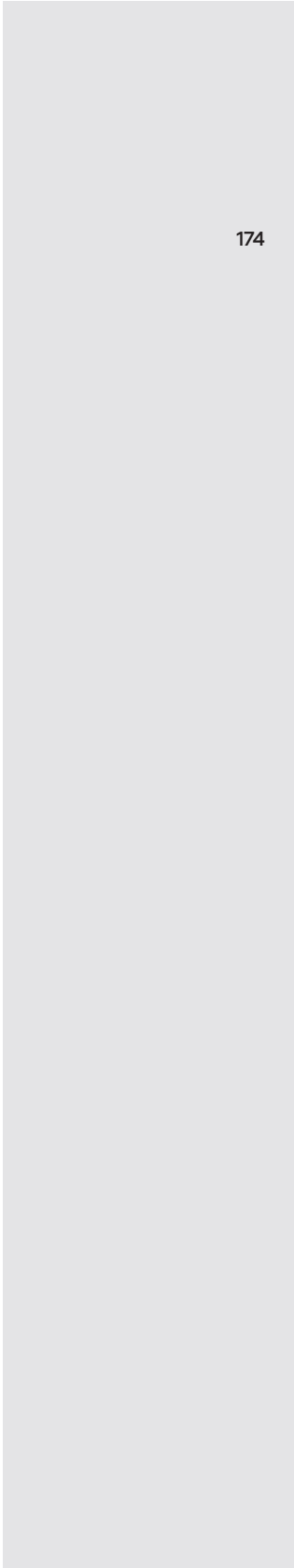

Base and Top Matrix



174

Base and Top Matrix

BASE AND TOP MATRIX





		Basic Round						Blok			Bolt Down	Brae			Brae Double	Disc			
		BA17L	BA17M	BA20M	BA22L	BA22M	BA22H	BA28H	BL18	BL22	BL26	JB	BR18	BR22	BR26	BRD1826	D18	D22	D26
Round 	Dia																		
	24	1							1			1						1	
	30		1						1			1	1					1	
	36			1						1		1	1						1
	42				1							1							1
	48					1					1	1		1					1
	54						1								1				1
	60							1							1				1
Oval 	W L																		
	36 72																		2
	42 54																		2
	42 78																		2
	42 84																		2
	48 78																		2
	48 96																		2
RD Square 	W L																		
	24 24	1										1	1					1	
	30 30		1									1	1					1	
	36 36			1								1		1					1
	42 42				1							1		1					1
	48 48						1					1			1				1
Square 	W L																		
	24 24	1							1			1	1					1	
	30 30		1						1			1	1					1	
	36 36			1						1		1		1					1
	42 42				1						1	1		1					1
	48 48						1				1	1			1				1
Extendo 	W L Dia																		
	30 30 42				1														1
	34 34 48					1									1				1
	36 36 51						1								1				1
	42 42 60							1							1				1

Based on standard height tables with standard tops. For quartz and other heavy tops, call WCI's Customer Service Department.

BASE AND TOP MATRIX

Rectangle	W	L	Basic Round						Blok			Bolt Down	Brae			Brae Double	Disc		
			BA17L	BA17M	BA20M	BA22L	BA22M	BA22H	BA28H	BL18	BL22	BL26	JB	BR18	BR22	BR26	BRD1826	D18	D122
	18	48																	
	18	60																	
	18	72																	
	18	84																	
	18	96																	
	24	30		1					1			1		1				1	
	24	36			1					1		1			1				1
	24	42				1				1		1			1			1	1
	24	48					1			2		1			1		1		1
	24	60	2							2		2		2				2	
	24	72	2									2		2				2	
	24	84												2				2	
	24	96												2				2	
	30	36			1					1		1			1				1
	30	42				1				1		1			1			1	1
	30	48					1				1	1			1		1		1
	30	60		2						2		2		2				2	
	30	72		2						2		2		2				2	
	30	84												2				2	
	30	96												2				2	
	36	42					1			1		1			1		1		1
	36	48						1			1	1			1		1		1
	36	60			2					2		2		2				2	
	36	72			2					2		2		2				2	
	36	84												2				2	
	36	96												2				2	
	42	72													2				2
	42	84													2				2
	42	96													2				2
	48	96													2				2
	48	120													2				2

BASE AND TOP MATRIX





		Dunhill					Flat Round			Kone			Platform			Platform Double					
		DU1818X	DU2424X	DU3030X	DU3636X	DU3636XH	DU18T	DU24T	DU30T	DU30TT	DU36TT	FR18	FR22	FR26	KO18	KO22	KO26	PL18	PL22	PL26	PLD1826
Round 	Dia																				
	24	1									1			1							
	30		1								1			1			1				
	36			1								1			1			1			
	42			1								1									
	48				1							1				1			1		
	54					1							1						1		
	60					1							1						1		
Oval 	W L																				
	36 72							2			2										
	42 54							2			2										
	42 78							2				2									
	42 84							2				2									
	48 78								2				2								
	48 96								2				2								
RD Square 	W L																				
	24 24	1									1										
	30 30		1								1										
	36 36			1								1									
	42 42				1							1									
	48 48				1								1								
Square 	W L																				
	24 24	1									1			1			1				
	30 30		1								1			1			1				
	36 36			1								1			1			1			
	42 42				1							1				1		1			
	48 48				1								1			1			1		
Extendo 	W L Dia																				
	30 30 42			1								1									
	34 34 48				1							1							1		
	36 36 51				1							1							1		
	42 42 60					1							1						1		

Based on standard height tables with standard tops. For quartz and other heavy tops, call WCI's Customer Service Department.

BASE AND TOP MATRIX

Rectangle	W	L	Dunhill					Flat Round			Kone			Platform			Platform Double					
			DU1818X	DU2424X	DU3030X	DU3636X	DU3636XH	DU18T	DU24T	DU30T	DU30TT	DU36TT	FR18	FR22	FR26	KO18	KO22	KO26	PL18	PL22	PL26	PLD1826
	18	48						2														
	18	60						2														
	18	72						2														
	18	84						2														
	18	96						2														
	24	30		1							1			1			1					
	24	36			1						1				1			1				
	24	42			1			2				1			1			1			1	
	24	48			1			2				1		2				1			1	
	24	60						2			2			2				2				
	24	72						2			2							2				
	24	84						2			2							2				
	24	96						2			2							2				
	30	36			1						1				1			1				
	30	42						2				1			1			1			1	
	30	48			1			2				1			1			1			1	
	30	60						2			2			2				2				
	30	72						2			2			2				2				
	30	84						2			2							2				
	30	96						2			2							2				
	36	42							2			1			1			1			1	
	36	48							2			1			1			1			1	
	36	60							2		2			2				2				
	36	72							2		2			2				2				
	36	84							2		2							2				
	36	96								2	2							2				
	42	72								2		2							2			
	42	84								2		2							2			
	42	96								2		2							2			
	48	96									2	2							2			
	48	120									2	2							2			

BASE AND TOP MATRIX





		Plus					Post Leg		Regency					Tulip										
		PU1818X	PU2424X	PU3030X	PU3636X	PU3636XH	PU18T	PU24T	PU30T	PU30TT	PU36TT	PO2.5"	PO3"	RG2424X	RG3030X	RG3636X	RG2142S	RG2448S	TL18L	TL18M	TL18H	TL24m	TL24H	TL24XH
Round 	Dia																							
	24	1																	1					
	30		1											1						1				
	36			1								4			1						1			
	42			1									4		1							1		
	48				1									4		1							1	
	54					1								4		1								1
	60					1								4		1								
Oval 	W L																							
	36 72								2			4				1					2			
	42 54								2				4			1					2			
	42 78								2					4		1						2		
	42 84								2					4				1				2		
	48 78										2				4			1						2
	48 96										2				4			1						2
RD Square 	W L																							
	24 24	1																						
	30 30		1											1										
	36 36			1											1									
	42 42				1											1								
	48 48					1											1							
Square 	W L																							
	24 24	1																	1					
	30 30		1											1						1				
	36 36			1								4			1						1			
	42 42				1								4			1							1	
	48 48					1							4				1							1
Extendo 	W L Dia																							
	30 30 42			1											1							1		
	34 34 48				1											1							1	
	36 36 51					1											1							1
	42 42 60																	1						1

Based on standard height tables with standard tops. For quartz and other heavy tops, call WCI's Customer Service Department.

BASE AND TOP MATRIX

Rectangle	W	L	Plus					Plus		Regency					Tulip									
			PU1818X	PU2424X	PU3030X	PU3636X	PU3636XH	PU18T	PU24T	PU30T	PU30TT	PU36TT	PO2.5"	PO3"	RG2424X	RG3030X	RG3636X	RG2142S	RG2448S	TL18L	TL18M	TL18H	TL24m	TL24H
	18	48						2																
	18	60						2																
	18	72						2																
	18	84						2																
	18	96						2																
	24	30		1															1					
	24	36			1															1				
	24	42			1			2													1			
	24	48			1			2														1		
	24	60						2											2					
	24	72						2											2					
	24	84						2											2					
	24	96						2											2					
	30	36			1																1			
	30	42						2														1		
	30	48			1			2					1										1	
	30	60						2				4							2					
	30	72						2				4							2					
	30	84						2				4							2					
	30	96						2				4							2					
	36	42							2			4									1			
	36	48							2			4										1		
	36	60							2			4								2				
	36	72							2			4								2				
	36	84							2			4								2				
	36	96								2		4								2				
	42	72									2		4								2			
	42	84									2		4								2			
	42	96									2		4								2			
	48	96										2		4								2		
	48	120										2		6								2		

BASE AND TOP MATRIX

		Slimline								Spacesaver						Tulip						
		SL1818X	SL2424X	SL3030X	SL3636X	SL18T	SL24T	SL30T	SL30TT	SL36TT	SV2222X	SV3030X	SV3636X	SV2430EX	SV18T	SV22T	TL18L	TL18M	TL18H	TL24m	TL24H	TL24XH
Round 	Dia																					
	24	1									1						1					
	30		1								1							1				
	36			1								1							1			
	42			1								1								1		
	48				1								1									1
	54				1								1									1
	60				1								1									
Oval 	W L																					
	36 72							2											2			
	42 54							2											2			
	42 78							2												2		
	42 84							2												2		
	48 78								2												2	
	48 96								2												2	
RD Square 	W L																					
	24 24	1									1											
	30 30		1								1											
	36 36			1								1										
	42 42				1								1									
	48 48				1								1									
Square 	W L																					
	24 24	1									1						1					
	30 30		1								1							1				
	36 36			1								1							1			
	42 42				1								1								1	
	48 48				1								1									1
Extendo 	W L Dia																					
	30 30 42			1								1								1		
	34 34 48				1								1								1	
	36 36 51				1								1									1
	42 42 60				1								1									1

Based on standard height tables with standard tops. For quartz and other heavy tops, call WCI's Customer Service Department.

BASE AND TOP MATRIX

		Slimline								Spacesaver						Tulip								
		SL1818X	SL2424X	SL3030X	SL3636X	SL18T	SL24T	SL30T	SL30TT	SL36TT	SV2222X	SV3030X	SV3636X	SV2430EX	SV18T	SV22T	TL18L	TL18M	TL18H	TL24m	TL24H	TL24XH		
Rectangle	W	L																						
	18	48					2																	
	18	60					2																	
	18	72					2																	
	18	84					2																	
	18	96					2																	
	24	30		1							1							1						
	24	36			1								1						1					
	24	42			1	2							1							1				
	24	48			1	2							1								1			
	24	60				2								2		2								
	24	72				2								2		2								
	24	84				2										2								
	24	96				2										2								
	30	36			1								1						1					
	30	42					2						1							1				
	30	48				1	2						1								1			
	30	60					2							2		2								
	30	72					2							2		2								
	30	84					2									2								
	30	96					2									2								
	36	42						2					1							1				
	36	48						2					1								1			
	36	60						2						2		2			2					
	36	72						2						2		2			2					
	36	84						2											2					
	36	96							2										2					
	42	72								2										2				
	42	84								2										2				
	42	96								2										2				
	48	96									2											2		
	48	120										2											2	

Base Only Pricing

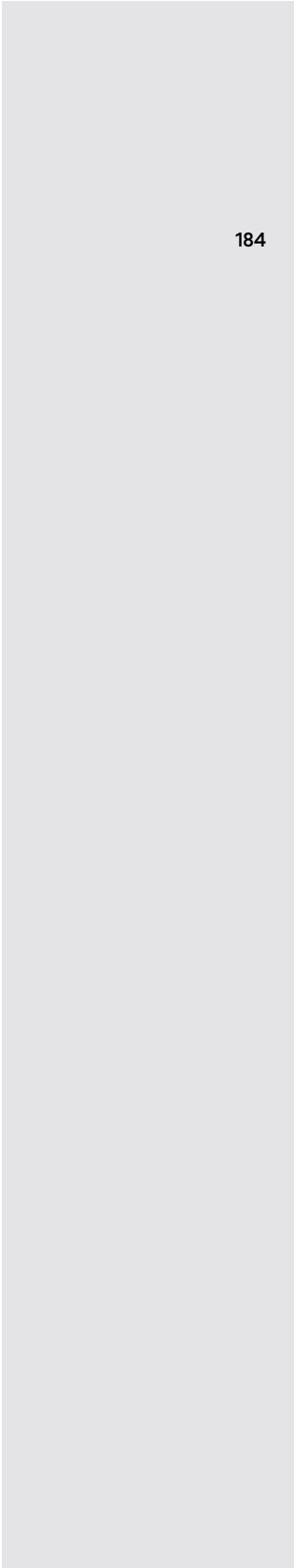

184

Base Only Pricing

BASE ONLY – Dining & Multipurpose

BASE ONLY LIST PRICING

Base	Code	Base Model #	Price	Base Size*	Base Style	Col. Dia.	Base Weight Lbs.	
Basic Round	BA	BA17L	258	17" dia.	Round	3"	29	
		BA17M	314	17" dia.	Round	3"	41	
		BA17H	366	17" dia.	Round	3"	45	
		BA20L	339	20" dia.	Round	3"	44	
		BA20M	366	20" dia.	Round	3"	51	
		BA20H	-	20" dia.	Round	3"	57	
		BA22L	357	22" dia.	Round	3"	50	
		BA22M	420	22" dia.	Round	3"	58	
		BA22H	482	22" dia.	Round	3"	65	
		BA28H	712	28" dia.	Round	3.5"	80	
Bolt Down	J Base	JB	JB	392	3" dia.	Boltdown	3"	10
Brae	BR	BR18	775	18"	RD Square	2"	46	
		BR22	1,061	22"	RD Square	2"	65	
		BR26	1,284	26"	RD Square	3"	97	
Brae Double	BRD	BRD1826	1,404	18" x 26"	RD Rectangle	2"	75	
Disc	DI	DI18	775	18" dia	Round	2"	38	
		DI22	1,061	22" dia	Round	2"	62	
		DI26	1,284	26" dia	Round	3"	77	
Dunhill	DU	DU1818X	839	18" x 18"	X	2.25"	18	
		DU2424X	959	24" x 24"	X	2.25"	25	
		DU3030X	1,077	30" x 30"	X	3	34	
		DU3636X	1,195	36" x 36"	X	3"	42	
		DU3636XH	1,309	36" x 36"	XH	3"	50	
		DU18T	493	18"	T	2"	30	
		DU24T	548	24"	T	2.25"	34	
		DU30T	606	30"	T	2.25"	40	
		DU30TT	707	30"	TT	2.25"	44	
DU36TT	763	36"	TT	2.25"	62			
Flat Round	FR	FR18	660	18" dia.	Round	3"	46	
		FR22	874	22" dia.	Round	3.5"	70	
		FR26	1,052	26" dia.	Round	3.5"	84	
Platform	PL	PL18	775	18" square	Sq.	2" Square	46	
		PL22	1,061	22" square	Sq.	2" Square	65	
		PL26	1,284	26" square	Sq.	3" Square	97	
		PL1826	1,404	18" x 26"	Rectangle	2" Square	75	

Continued on next page

Continued on next page

*Base sizes may vary depending on weight of top

**Polished/Satin Aluminum only available on Alumiline and Mark IV series
Polished/Satin Chrome upcharge priced per column

***Custom Powder Coat upcharge applied per order

BASE ONLY FINISH UPCHARGES

Black Wrinkle	Powder Coat	Satin/Polished Chrome/Alu.**	Premium Plated	Custom PowderCoat***	Stainless Steel
standard	127	275	550	419	N/A
standard	127	275	550	419	N/A
standard	127	275	550	419	N/A
standard	127	275	550	419	N/A
standard	127	275	550	419	N/A
standard	127	275	550	419	N/A
standard	127	275	550	419	N/A
standard	127	275	550	419	N/A
standard	127	275	550	419	N/A
- standard		88	138	419	1,650
- standard		660	1,430	419	1,650
- standard		660	1,430	419	1,650
- standard		660	1,430	419	1,650
- standard		770	1,540	419	1,650
- standard		660	1,430	419	1,650
- standard		660	1,430	419	1,650
- standard		660	1,430	419	1,650
- standard		413	715	419	1,650
- standard		413	715	419	1,650
- standard		413	715	419	1,650
- standard		413	715	419	1,650
- standard		413	715	419	1,650
- standard		207	385	419	1,650
- standard		207	385	419	1,650
- standard		207	385	419	1,650
- standard		207	385	419	1,650
- standard		275	550	419	1,650
- standard		275	550	419	1,650
- standard		275	550	419	1,650
- standard		660	1,430	419	1,650
- standard		660	1,430	419	1,650
- standard		660	1,430	419	1,650
- standard		660	1,430	419	1,650

Base Options

Alternate Height Counter, Bar, & Alternative Height	CH, BH, & AH	76
Glides Super Level	GSL	40
Casters Locking Casters 2" Twin Wheel (qty. 4) (Dunhill, Mark IV, Post Leg, Slimline, Tuscan)	TWC2	65
Locking Casters 3" Mag Wheel (qty. 4) (Vista)	MWC3	193
Top Plate Custom Top Plate Size	CTPS	1
6" Column (Basic Round, Disc, or Flat Round)		
6" Column (black texture and powder coat)	COL6	224
6" Column (polished or satin chrome)	COLP6	286
6" Column (premium plated)	COLPP6	1
6" Column (veneer)	COLV6	446
Footring (Basic Round, Flat Round, Bolt-down, Disc, or Platform)		
Footring 14" (per base)	FO14	254
Footring 19" (per base)	FO19	286
Footring Finish: Polished or Satin Chrome only		
Outdoor Use Outdoor Undercoat (includes GSL)	OD	82
Tilt-Top Tilt-top - (standard cable release) TMX/TMT For use on table bases with up to a 2.5" column diameter. The cable release mechanism activates both mechanisms on a table with two single column T-bases. It is not available on TT bases.	284 X-base / 439 T-base	

1 Call for pricing 844.815.2217

BASE ONLY – Dining & Multipurpose

BASE ONLY LIST PRICING

Base	Code	Base Model #	Price	Base Size*	Base Style	Col. Dia.	Base Weight Lbs.
Platform Double	PLD	PL1826	1,404	18" x 26"	Rectangle	2" Square	75
Plus	PU	PU1818X	839	18" x 18"	X	2.25"	18
		PU2424X	959	24" x 24"	X	2.25"	25
		PU3030X	1,077	30" x 30"	X	3	34
		PU3636X	1,195	36" x 36"	X	3"	42
		PU3636XH	1,309	36" x 36"	XH	3"	50
		PU18T	493	18"	T	2"	30
		PU24T	548	24"	T	2.25"	34
		PU30T	606	30"	T	2.25"	40
		PU30TT	707	30"	TT	2.25"	44
PU36TT	763	36"	TT	2.25"	62		
Post Leg	PO	PO1.5	258	1.5" dia.	Post	1.5"	4
		PO2.5	276	2.5" dia.	Post	2.5"	6
		PO3	293	3" dia.	Post	3"	7
Regency	RG	RG2424X	1,533	24" x 24"	X -bar size 1/2"	2.5"	18
		RG3030X	1,660	30" x 30"	X -bar size 1/2"	2.5"	22
		RG3636X	3,529	36" x 36"	X -bar size 1"	3.5"	60
		RG4848X	4,458	48" x 48"	X -bar size 1"	3.5"	86
		RG2142S	4,636	21" x 42"	Scissor -bar size 1"	3.5"	84
		RG2448S	4,813	24" x 48"	Scissor -bar size 1"	3.5"	85
Tulip	TL	TL18L	955	18" dia.	Round	2"	35
		TL18M	1,042	18" dia.	Round	2"	45
		TL18H	1,155	18" dia.	Round	2"	55
		TL24M	1,217	24" dia.	Round	2.25"	55
		TL24H	1,402	24" dia.	Round	2.25"	65
		TL24XH	1,456	24" dia.	Round	2.25"	75

*Base sizes may vary depending on weight of top

**Polished/Satin Aluminum only available on Alumiline and Mark IV series

***Custom Powder Coat upcharge applied per order

BASE ONLY FINISH UPCHARGES

Black Wrinkle	Powder Coat	Satin/Polished Chrome/Alu.**	Premium Plated	Custom PowderCoat***	Stainless Steel
-	standard	770	1,540	419	1,650
-	standard	413	715	419	1,650
-	standard	413	715	419	1,650
-	standard	413	715	419	1,650
-	standard	413	715	419	1,650
-	standard	207	385	419	1,650
-	standard	207	385	419	1,650
-	standard	207	385	419	1,650
-	standard	207	385	419	1,650
-	standard	207	385	419	1,650
-	standard	88	138	419	1,650
-	standard	88	138	419	1,650
-	standard	88	138	419	1,650
-	standard	825	1,650	419	N/A
-	standard	825	1,650	419	N/A
-	standard	825	1,650	419	N/A
-	standard	825	1,650	419	N/A
-	standard	825	1,650	419	N/A
-	standard	825	1,650	419	N/A
-	standard	275	550	419	1,650
-	standard	275	550	419	1,650
-	standard	275	550	419	1,650
-	standard	275	550	419	1,650
-	standard	275	550	419	1,650
-	standard	275	550	419	1,650

Base Options

Alternate Height		
Counter, Bar, & Alternative Height	CH, BH, & AH	76
Glides		
Super Level	GSL	40
Casters		
Locking Casters 2" Twin Wheel (qty. 4)	TWC2	65
(Dunhill, Mark IV, Post Leg, Slimline, Tuscan)		
Locking Casters 3" Mag Wheel (qty. 4)	MWC3	193
(Vista)		
Top Plate		
Custom Top Plate Size	CTPS	1
6" Column (Basic Round, Disc, or Flat Round)		
6" Column (black texture and powder coat)	COL6	224
6" Column (polished or satin chrome)	COLP6	286
6" Column (premium plated)	COLPP6	1
6" Column (veneer)	COLV6	446
Footring (Basic Round, Flat Round, Bolt-down, Disc, or Platform)		
Footring 14" (per base)	FO14	254
Footring 19" (per base)	FO19	286
Footring Finish: Polished or Satin Chrome only		
Outdoor Use		
Outdoor Undercoat (includes GSL)	OD	82
Tilt-Top		
Tilt-top - (standard cable release) TMX/TMT	284 X-base / 439 T-base	
For use on table bases with up to a 2.5" column diameter.		
The cable release mechanism activates both mechanisms on a table with		
two single column T-bases. It is not available on TT bases.		

1 Call for pricing

844.815.2217

BASE ONLY – Outdoor

BASE ONLY LIST PRICING

Base	Code	Base Model #	Price	Base Size*	Base Style	Col. Dia.	Base Weight	
								Lbs.
Basic Round	BA	BA14LOD	315	14" dia.	Round	3"		30
		BA17LOD	333	17" dia.	Round	3"		35
		BA17MOD	388	17" dia.	Round	3"		45
		BA17HOD	440	17" dia.	Round	3"		55
		BA20LOD	414	20" dia.	Round	3"		45
		BA20MOD	440	20" dia.	Round	3"		55
		BA20HOD	476	20" dia.	Round	3"		65
		BA22LOD	431	22" dia.	Round	3"		55
		BA22MOD	495	22" dia.	Round	3"		65
		BA22HOD	557	22" dia.	Round	3"		75
		BA28HOD	787	28" dia.	Round	3"		95
Brae	BR	BR18OD	850	18"	RD Square	2"		46
		BR22OD	1,136	22"	RD Square	2"		65
		BR26OD	1,359	26"	RD Square	3"		97
Brae Double	BRD	BRD1826OD	1,404	18" x 26"	RD Rectangle	2"		75
Disc	DI	DI18OD	850	18" dia	Round	2"		38
		DI22OD	1,136	22" dia	Round	2"		62
		DI26OD	1,359	26" dia	Round	3"		77
Flat Round	FR	FR18OD	735	18" dia.	Round	3"		46
		FR22OD	949	22" dia.	Round	3.5"		70
		FR26OD	1,127	26" dia.	Round	3.5"		84
Platform	PL	PL18OD	850	18" square	Square	2" Square		46
		PL22OD	1,136	22" square	Square	2" Square		65
		PL26OD	1,359	26" square	Square	3" Square		97
		PL1826OD	1,479	18" x 26"	Rectangle	2" Square		75
Platform Double	PLD	PLD1826OD	1,479	18" x 26"	Rectangle	2" Square		75
Tulip	TL	TL18LOD	1,030	18" dia.	Round	2"		35
		TL18MOD	1,117	18" dia.	Round	2"		45
		TL18HOD	1,230	18" dia.	Round	2"		55
		TL24MOD	1,292	24" dia.	Round	2.25"		55
		TL24HOD	1,476	24" dia.	Round	2.25"		65
		TL24XHOD	1,531	24" dia.	Round	2.25"		75

*Polished/Satin Aluminum only available on Alumiline and Mark IV series

**Custom Powder Coat upcharge applied per order

BASE ONLY FINISH UPCHARGES

Black Wrinkle	Powder Coat	Satin/Polished Chrome/Alu.**	Premium Plated	Custom PowderCoat***	Stainless Steel
standard	116	-	N/A	419	N/A
standard	116	-	N/A	419	N/A
standard	116	-	N/A	419	N/A
standard	116	-	N/A	419	N/A
standard	116	-	N/A	419	N/A
standard	116	-	N/A	419	N/A
standard	116	-	N/A	419	N/A
standard	116	-	N/A	419	N/A
standard	116	-	N/A	419	N/A
standard	116	-	N/A	419	N/A
- standard	-	-	N/A	419	1,650
- standard	-	-	N/A	419	1,650
- standard	-	-	N/A	419	1,650
- standard	-	-	N/A	419	1,650
- standard	-	-	N/A	419	1,650
- standard	-	-	N/A	419	1,650
- standard	-	-	N/A	419	N/A
- standard	-	-	N/A	419	N/A
- standard	-	-	N/A	419	N/A
- standard	-	-	N/A	419	1,650
- standard	-	-	N/A	419	1,650
- standard	-	-	N/A	419	1,650
- standard	-	-	N/A	419	1,650
- standard	-	-	N/A	419	1,650
- standard	-	-	N/A	419	1,650
- standard	-	-	N/A	419	1,650
- standard	-	-	N/A	419	1,650
- standard	-	-	N/A	419	1,650
- standard	-	-	N/A	419	1,650
- standard	-	-	N/A	419	1,650
- standard	-	-	N/A	419	1,650
- standard	-	-	N/A	419	1,650
- standard	-	-	N/A	419	1,650
- standard	-	-	N/A	419	1,650

Base Options

Alternate Height Counter, Bar, & Alternative Height	CH, BH, & AH	69
Top Plate Custom Top Plate Size	CTPS	1
6" Column (Basic Round, Disc or Flat Round)		
6" Column (black texture and powder coat)	COL6	204

1 Call for pricing 844.815.2217

Top Only Pricing

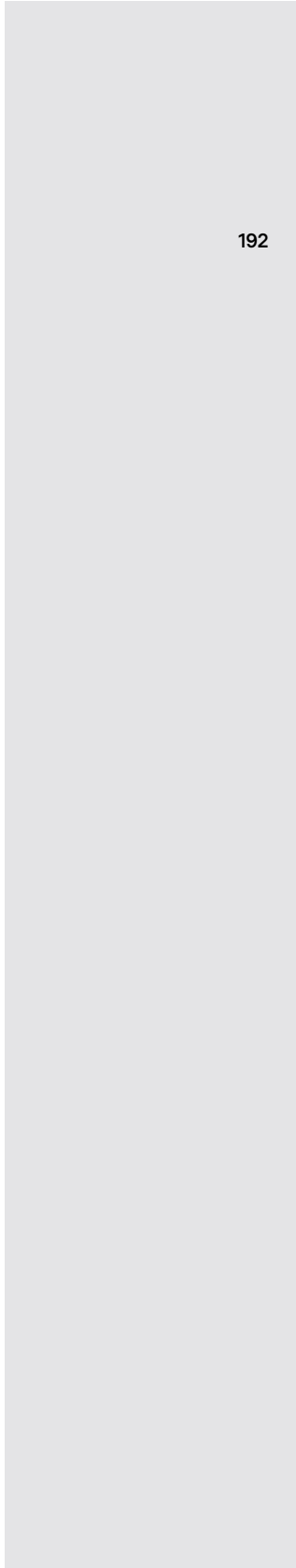

192

Top Only Pricing

TOP ONLY

Laminate Surface					Wood Surface				
Self Edge	Vinyl Edges	PVC Edges	Wood Edges Group A	Wood Edges Group B	Wood Edges Group A	Wood Edges Group B	Butcher Block		
LLSE Self Edge	LVFL Flat	LPVC PVC	LWFL Flat	LWSQ Square	WWFL Flat	WWSQ Square	BBFL Flat		
	LVBP Bumper		LWTP Tapered Ply	LWBN Bullnose	WWTP Tapered Ply	WWBN Bullnose	BBBN Bullnose		
			LWFP Flat Ply	LWPR Prism	WWFP Flat Ply	WWPR Prism			

Top Only List Pricing

	Top Size			Model #								
	24			24RD	300	300	380	633	901	648	1,016	882
	30			30RD	397	397	495	812	1,099	922	1,238	1,274
	36			36RD	524	524	639	1,013	1,346	1,054	1,513	1,762
	42			42RD	684	684	813	1,197	1,608	1,346	1,808	2,598
	48			48RD	849	849	993	1,418	1,890	1,595	2,126	3,036
	54			54RD	1,026	1,026	1,193	1,762	2,736	1,982	3,076	-
	60			60RD	1,307	1,307	1,486	1,952	2,866	2,525	3,226	-
	36	72		3672OV	993	993	1,074	1,405	1,760	1,680	2,024	-
	42	54		4254OV	956	956	1,001	1,326	1,846	1,566	1,943	-
	42	78		4278OV	1,421	1,421	1,488	1,795	2,145	2,021	2,414	-
	42	84		4284OV	1,510	1,510	1,596	1,875	2,274	2,106	2,559	-
	48	78		4878OV	1,566	1,566	1,657	1,925	2,323	2,169	2,613	-
	48	96		4896OV	1,846	1,846	1,935	2,162	2,595	2,739	3,243	-
	30	30	42	303042EX	1,513	-	-	3,561	4,324	3,741	4,911	-
	34	34	48	343448EX	1,717	-	-	3,785	4,865	3,965	5,451	-
	36	36	51	363651EX	1,844	-	-	4,054	5,136	4,236	5,723	-
	42	42	60	424260EX	2,230	-	-	4,649	5,585	4,777	6,172	-
	24	24		2424RS	302	302	390	633	901	648	1,016	993
	30	30		3030RS	397	397	505	812	1,099	922	1,238	1,421
	36	36		3636RS	524	524	633	996	1,346	1,054	1,513	1,949
	42	42		4242RS	664	664	787	1,197	1,608	1,346	1,808	2,892
	48	48		4848RS	851	851	993	1,418	1,890	1,595	2,126	3,380
	17	17		1717SQ	-	-	-	-	-	-	-	-
	20	20		2020SQ	-	-	-	-	-	-	-	-
	24	24		2424SQ	302	302	390	633	901	648	1,016	993
	30	30		3030SQ	397	397	505	812	1,099	922	1,238	1,421
	36	36		3636SQ	524	524	633	996	1,346	1,054	1,513	1,949
	42	42		4242SQ	664	664	787	1,197	1,608	1,346	1,808	2,892
	48	48		4848SQ	851	851	993	1,418	1,890	1,595	2,126	3,380

Continued on next page

Extendo available in LLSE, LWFL, LWSQ, WWFL, WWSQ, ULFP, ULFR Only

Solid Surface Quartz Surface

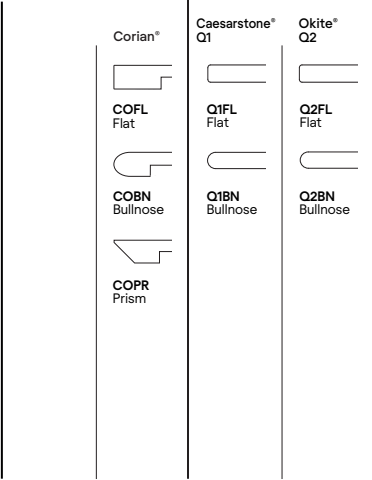

1,136	3,063	4,388
1,570	4,029	6,377
2,123	5,663	7,703
2,746	7,026	9,915
3,452	-	-
4,224	-	-
5,100	-	-
-	-	-
-	-	-
-	-	-
-	-	-
-	-	-
-	-	-
-	-	-
-	-	-
-	-	-
-	-	-
-	-	-
-	-	-
-	-	-
-	-	-
5,031	-	-
6,821	-	-
8,900	-	-
-	-	-
-	-	-
1,002	1,873	3,718
1,402	3,254	5,486
1,935	4,230	6,902
2,522	5,891	8,669
3,208	-	-

Options



















Top Materials and Finishes		
Premium Laminates		📞
Custom Wood Veneer	CWV	📞
Stain to Match (set-up charge)	STM	476
Top Options		
3" Radius Corner (per corner) (laminare self edge, ultrafoam, Corian®)	CRL3	40
3" Wood Radius Corner (per corner) (not available in LWFL, WWFL, LWPI and WWPI)	CRW3	95
Custom Radius Corner	CRC	95
Custom Size	CS	📞
Custom Shape	CSH	📞
Edge Options		
1.75" Thick Edge (see edge details for specific profiles)	175E	5% (per table)

📞 Call for pricing 844.815.2217

TOP ONLY

Laminate Surface

Wood Surface

Self Edge	Vinyl Edges	PVC Edges	Wood Edges Group A	Wood Edges Group B	Wood Edges Group A	Wood Edges Group B	Butcher Block
 LLSE Self Edge	 LVFL Flat	 LPVC PVC	 LWFL Flat	 LWSQ Square	 WWFL Flat	 WWSQ Square	 BBFL Flat
	 LVBP Bumper		 LWTP Tapered Ply	 LWBN Bullnose	 WWTP Tapered Ply	 WWBN Bullnose	 BBBN Bullnose
			 LWFP Flat Ply	 LWPR Prism	 WWFP Flat Ply	 WWPR Prism	

Top Only List Pricing

	Top Size		Model #								
Rectangle	18	48	1848RE	416	416	497	684	1,082	789	1,126	1,261
	18	60	1860RE	495	495	591	812	1,261	913	1,354	1,369
	18	72	1872RE	569	569	674	946	1,441	1,054	1,579	1,550
	18	84	1884RE	812	812	894	1,176	1,666	1,326	1,875	1,803
	18	96	1896RE	946	946	1,020	1,268	1,846	1,426	2,040	1,982
	20	30	2030RE	-	-	-	546	930	616	1,049	-
	20	36	2036RE	-	-	-	606	1,008	682	1,136	-
	24	30	2430RE	347	347	423	730	1,026	858	1,154	1,179
	24	36	2436RE	392	392	476	829	1,117	934	1,259	1,393
	24	42	2442RE	445	445	517	894	1,213	1,006	1,362	1,700
24	48	2448RE	501	501	591	1,008	1,362	1,136	1,531	1,787	
24	60	2460RE	600	600	696	1,144	1,546	1,284	1,737	2,186	
24	72	2472RE	692	692	803	1,298	1,758	1,461	1,980	2,584	
24	84	2484RE	1,037	1,037	1,141	1,428	2,206	1,608	2,483	2,877	
24	96	2496RE	1,130	1,130	1,243	1,558	2,398	1,752	2,700	3,168	
30	36	3036RE	464	464	535	913	1,228	1,028	1,381	1,665	
30	42	3042RE	521	521	603	1,064	1,418	1,195	1,594	2,054	
30	48	3048RE	579	579	669	1,136	1,521	1,280	1,710	2,149	
30	60	3060RE	707	707	810	1,313	1,752	1,478	1,970	2,624	
30	72	3072RE	816	816	940	1,433	1,933	1,615	2,171	3,108	
30	84	3084RE	1,185	1,185	1,290	1,585	2,362	1,782	2,654	3,400	
30	96	3096RE	1,298	1,298	1,413	1,736	2,636	1,952	2,964	3,693	
36	42	3642RE	597	597	689	1,154	1,543	1,300	1,733	2,395	
36	48	3648RE	662	662	759	1,238	1,655	1,393	1,857	2,500	
36	60	3660RE	813	813	929	1,405	1,877	1,583	2,113	3,050	
36	72	3672RE	944	944	1,066	1,609	2,142	1,809	2,411	3,610	
36	84	3684RE	1,333	1,333	1,445	1,775	2,516	1,997	2,831	4,167	
36	96	3696RE	1,465	1,465	1,596	1,943	2,794	2,186	3,142	4,716	
42	72	4272RE	1,078	1,078	1,182	1,713	2,342	1,825	2,490	-	
42	84	4284RE	1,485	1,485	1,596	1,892	2,703	2,269	3,200	-	
42	96	4296RE	1,634	1,634	1,757	2,087	3,063	2,495	3,270	-	
48	96	4896RE	1,810	1,810	1,932	2,382	3,423	2,974	3,751	-	
48	120	48120RE	2,149	2,149	2,304	2,767	3,785	3,460	4,236	-	

Continued on next page

Solid Surface Quartz Surface

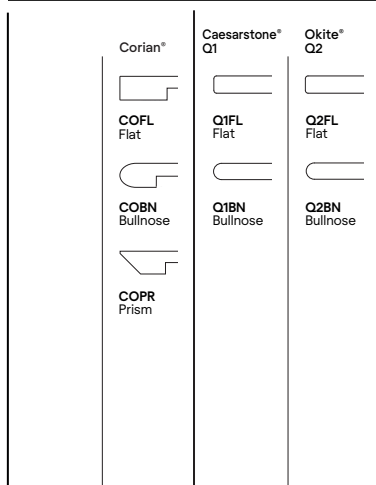

-	-	-
-	-	-
-	-	-
-	-	-
-	-	-
-	-	-
-	-	-
-	-	-
-	-	-
1,185	1,853	4,248
1,366	2,118	4,779
1,543	2,490	5,132
1,723	-	-
2,114	-	-
2,493	-	-
-	-	-
-	-	-
1,626	2,793	5,663
1,844	3,037	5,841
2,087	-	-
2,541	-	-
2,998	-	-
-	-	-
-	-	-
2,449	3,729	7,008
2,971	-	-
3,007	-	-
3,528	-	-
-	-	-
-	-	-
-	-	-
-	-	-
-	-	-
-	-	-
-	-	-
-	-	-



















Options

Top Materials and Finishes		
Premium Laminates		📞
Custom Wood Veneer	CWV	📞
Stain to Match (set-up charge)	STM	476
Top Options		
3" Radius Corner (per corner) (laminare self edge, ultrafoam, Corian®)	CRL3	40
3" Wood Radius Corner (per corner) (not available in LWFL, WWFL, LWPI and WWPI)	CRW3	95
Custom Radius Corner	CRC	95
Custom Size	CS	📞
Custom Shape	CSH	📞
Edge Options		
1.75" Thick Edge (see edge details for specific profiles)	175E	5% (per table)

📞 Call for pricing

844.815.2217







TOP ONLY

Laminate Surface				Wood Surface			
Self Edge	Vinyl Edges	PVC Edges	Wood Edges Group A	Wood Edges Group B	Wood Edges Group A	Wood Edges Group B	Butcher Block
 LSE Self Edge	 LVFL Flat	 LPVC PVC	 LWFL Flat	 LWSQ Square	 WWFL Flat	 WWSQ Square	 BBFL Flat
	 LVBP Bumper		 LWTP Tapered Ply	 LWBN Bullnose	 WWTP Tapered Ply	 WWBN Bullnose	 BBBN Bullnose
			 LWFP Flat Ply	 LWPR Prism	 WWFP Flat Ply	 WWPR Prism	

Top Only List Pricing

RD Rectangle	Top Size		Model #	445	445	517	894	1,213	1,006	1,362	1,700
	24	42									
	24	48	2448RR	501	501	591	1,008	1,362	1,136	1,531	1,787
	30	48	3048RR	579	579	669	1,136	1,521	1,280	1,710	2,149
	36	48	3648RR	662	662	759	1,238	1,655	1,393	1,857	2,500

Solid Surface Quartz Surface

Corian®	Caesarstone® Q1	Okite® Q2
		
COFL Flat	Q1FL Flat	Q2FL Flat
		
COBN Bullnose	Q1BN Bullnose	Q2BN Bullnose
		
COPR Prism		

1,543	2,490	5,132
1,723	-	-
2,087	-	-
2,971	-	-

Options

Top Materials and Finishes

Premium Laminates		📞
Custom Wood Veneer	CWV	📞
Stain to Match (set-up charge)	STM	476

Top Options

3" Radius Corner (per corner) (laminare self edge, ultrafoam, Corian®)	CRL3	40
3" Wood Radius Corner (per corner) (not available in LWFL, WWFL, LWPI and WWPI)	CRW3	95
Custom Radius Corner	CRC	95
Custom Size	CS	📞
Custom Shape	CSH	📞

Edge Options

1.75" Thick Edge (see edge details for specific profiles)	175E	5% (per table)
--	------	----------------

📞 Call for pricing

844.815.2217

Options Pricing

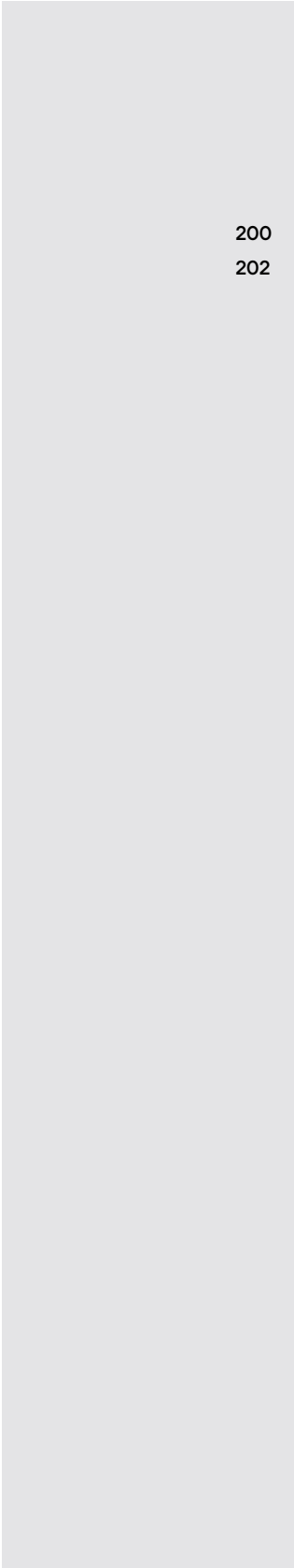

200 Options Pricing
202 Power & Data

OPTIONS PRICING

Base Options

AH **Alternate Height Base** **76**

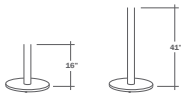

WCI table bases are available in a custom height within the range of 16" – 41" (per column). Alternate height Florentine bases are 174.

GSL **Super Level Glides** **40**



Overall height of .75" is recommended for use on uneven or hard surface floors. Eliminates table wobble by automatically self-leveling. Adjusts up to .25" of wobble. Super level glides will not affect the overall height of the table. Super Level Glides are not available on Blok, Disc, Kone or Platform series. Sold in set of 5 (per base).

TMX/TMT **Tilt-top with Standard Cable Release** **X-base 312**
T-base 483

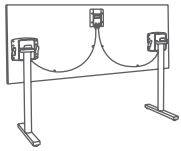

For use on table bases with up to a 2.5" column diameter. The cable release mechanism activates both mechanisms on a table with two single column T-bases. It is not available on TT bases or Post Leg.

TWC2 **Casters 2" Twin Wheel** **65**



Twin Wheel Casters are 2" diameter black nylon with a black nylon hood and locking tab. Casters will not affect the overall height of the table. Casters are available on Dunhill, Mark IV, Plus, Post Leg, Slimline and Tuscan series. Sold in set of 4.

FM **Folding Mechanism** **T-base 312**

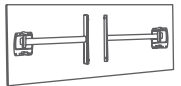

Folding table mechanism must be activated individually. The folding mechanism is available on Dunhill, Mark IV, Plus, Slimline and Tuscan T-bases only. It is not available on TT bases or Post Leg. For use on tables bases with up to a 2.5" column diameter.

MWC3 **Casters 3" Mag Wheel** **193**



Mag Wheel Casters are 3" diameter, single wheel, black polyurethane, with a spoked cast iron core, black chrome plated fork finish and a top locking tab. Casters will not affect the overall height of the table. Casters are available on Vista tables series only. Not Available on Vista with Quartz tops. Sold in set of 4.

Wall Cleats and Cantilever

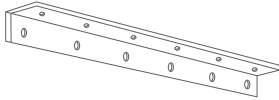
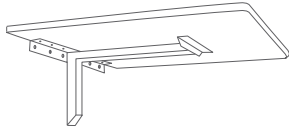
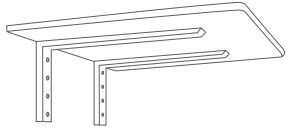

	Size	Maximum Top Size	Model #	
Wall Cleat	20	36" wide	WC20	54
				
Cantilever Table Bracket Single	16 21	30" x 36"	CTBS21	199
	16 33	30" x 48"	CTBS33	248
				
Cantilever Table Bracket Double	12 12	24" x 24"	CTBD12	187
	16 18	30" x 24"	CTBD18	219
	16 24	30" x 30"	CTBD24	252
	16 30	36" x 36"	CTBD30	285
	16 36	36" x 42"	CTBD36	318
	16 42	36" x 48"	CTBD42	352
				

OPTIONS PRICING



Top Options

CS & CSH	Custom Size/Shape	1
	WCI can manufacture many different size and shape tops; please call customer service 844-815-2217 for more information	
CET	Custom Edge Thickness	1
	WCI can manufacture specific customer edge thickness; please call customer service 844-815-2217 for more information	
CRC	Custom Radius Corner	95
	WCI can manufacture specific custom radius corners; please call customer service 844-815-2217 for more information	
CRL3	3" Radius Corner	40
	3" Radius corners are available on laminate tops with a self-edge, also available on Ultrafoam and Corian® tops. (per corner)	
CRW3	3" Wood Radius Corner	95
	3" Radius corners are available on laminate tops with wood edges. Not available in LWFL, WWFL, LWPI, WWPI (per corner)	
UMB	2" Umbrella Hole	286
	Available on Outdoor Basic Round, Bistro, Flat Round, Disc, Park and Platform tables only (per table).	

Grommets

GMBM, GMSC & GMPC	2" Round Metal Grommet	160
	Matte black (GMBM), Satin chrome (GMSC) Polished chrome (GMPC)	
GPMBM	2" Round Plastic Grommet	51
	Matte black (GPMBM)	

Wire Management

WMJ	Black Plastic J-Trough 48" long	134
	Under table mounted J-trough provides concealed cable management. Matte black plastic, attachment hardware not included.	
WML	Legway Wire Manager 26"	65
	Vertical trough provides concealed cable management. Matte black plastic, attachment adhesive included.	

Ganging Clips

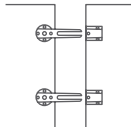
GC	Ganging Clips	171
	Connects two table tops for use as one large table. Friction and bolt release allows for quick separation. Set includes two clips and two brackets. One set is recommended per table side.	

POWER & DATA OPTIONS

Node®



The Node's clean, flush mount design complements a wide range of aesthetics. Its design is versatile yet discreet, offering a range of power, data, and USB configurations.

Standard Features:		Canvas only	All Other Tables
Finishes:	Parchment, Black, Silver		
Configurations:			
NOD2-A	2 Power	812	190
NOD2-B	1 Power and 2 USB chargers	891	268
NOD2-C	1 Power and 1 USB-A and 1 USB_C	891	268
Cord Lengths:	72" or 120" (Standard)		

Tully®



Traditional meeting and collaborative tables aren't the only places people work today. WCI's custom designed banquettes and seating offer comfortable, flexible workspaces which keep you connected. Tully tucks right into those comfortable spaces to keep you powered up. Tully also mounts discreetly under that collaborative work surface.

Standard Features:		Canvas only	All Other Tables
Finishes:	White Plastic w/ Silver Braided Cord, Black Plastic w/ Gunmetal Braided Cord		
Configurations:			
TUL3	1 Power and 2 USB-A and 1 USB-C (9" or 2" tail)	1,053	396
Cord Lengths:	120" Braided Cord (Standard)		
	ETL Listed		

Mini-Tap®



The Mini-Tap Power provides 2 outlets with key slots, allowing the power to be placed near the edge of the work surface. A great option to avoid cutting into the surface, and offering easy access to power.

Standard Features:		Canvas only	All Other Tables
Finishes:	Black only		
Configurations:			
MIN2-A	2 Power	750	125
MIN2-B	1 Power and 1 USB-A	842	218
Cord Lengths:	72" or 120" (Standard)		
	Assembly required		

Node®, Tully®, Mini-Tap®, Ellora® B, Double Ellora® B, and MS2 — BYRNE electric.
Customer may specify alternate power and data modules. Modules must be approved by WCI engineering.

Ellora® B



Ellora B manages power and data with ease. With its clean powder coated finish and seamless, one-piece aluminum frame, the design is contemporary and understated. When in use, the lid opens for easy access at the work surface but closes softly to hide cable clutter out of sight.

Standard Features:		Canvas only	All Other Tables
Finishes:	Matte White, Matte Fog, Matte Storm		
Configurations:			
SEL4-A	3 Power and 1 USB	1,053	429
SEL4-B	2 Power and 2 USB	1,146	506
SEL4-C	4 Power	1,053	429
Cord Lengths:	72" or 120" (Standard)		
UL Listed			

Double Ellora® B



Double Ellora B offers the same seamless in-surface design as the classic Ellora B maintaining the same contemporary and understated design. The same scalable power and data options are available—but doubled—so it can deliver easy access from both sides of the table.

Standard Features:		Canvas only	All Other Tables
Finishes:	Matte White, Matte Fog, Matte Storm		
Configurations:			
DEL4-A	2 Power and 1 USB charger and 1 USB A+C (each side)	1,628	1,003
DEL4-B	4 Power	1,385	820
Cord Lengths:	72" or 120" (Standard)		
UL Listed			

MS2



MS2 is a side-by-side solution for conference tables that provides access to power and data from both sides or one side. Thanks to its one-touch access in a streamlined design, MS2 power and data is totally concealable. MS2 can be customized with a full line of technology accessories.

Standard Features:		Canvas only	All Other Tables
Finishes:	Silver Anodized Aluminum Black Anodized Aluminum		
Configurations:			
MS24-A	2 Power and 1 USB charger and 1 USB A+C (each side) Silver Anodized Aluminum	1,628	1,003
MS24-B	2 Power and 1 USB charger and 1 USB A+C(each side) Black Anodized Aluminum	1,385	820
Cord Lengths:	72" or 120" (Standard)		
UL Listed	72' Hard wired (Anodized Aluminum Only)		

Includes a Voice/Data Adapter Kit (BE01421) to accept couplers & jacks when required
Configurations with four or more power receive a Circuit Breaker Cord

W	C
---	---