



# PRICE LIST

December 2024

A 2% Adjustment Fee  
will be added to all orders,  
effective May 1, 2025.

**WEST  
COAST  
INDUSTRIES**



# Table of Contents

2	Statement of Line
7	General Information
14	Product Specifications
48	Pricing
173	Base and Top Matrix
183	Base Only Pricing
191	Top Only Pricing
199	Options Pricing
202	Power & Data

# STATEMENT OF LINE – Tables

## DINING & MULTIPURPOSE



Basic Round



Blok



Bolt Down



Brae



Brae Double



Canvas



Disc



Dunhill



Flat Round



Kone



Move



Parsons

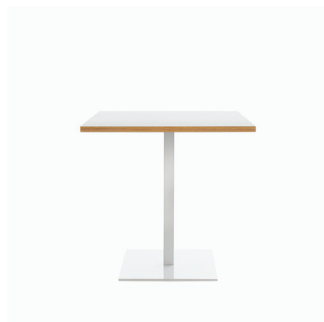

Platform



Platform Double



Plus



Post Leg

# STATEMENT OF LINE – Tables

## DINING & MULTIPURPOSE



Regency



Tulip



Vista

## OCCASIONAL

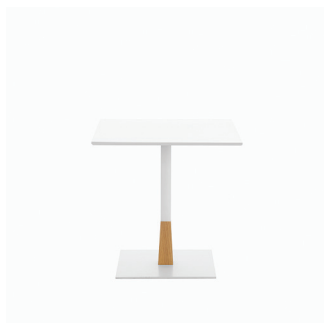

Blok



Brae



Cube



Cylinder



Disc



Kone



Move



Parsons



Platform



Triad

# STATEMENT OF LINE – Tables

## OUTDOOR TABLES



Basic Round



Brae



Brae Double



Disc



Flatround



Platform



Platform Double



Tulip



Vista

# STATEMENT OF LINE – SEATING



Single

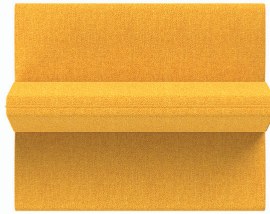

Double



U-Shape



3/4 Circle



Straight



L-Shape



Custom Curve

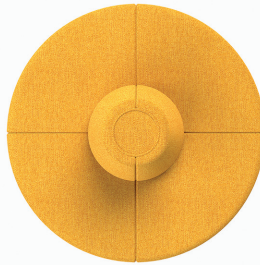

Rotunda



Ellipse

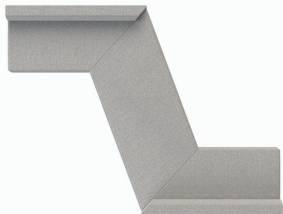

Zig



Bench



Ottoman

Custom shapes are available upon request.  
Images shown are representations of WCI standard configurations.



# General Information

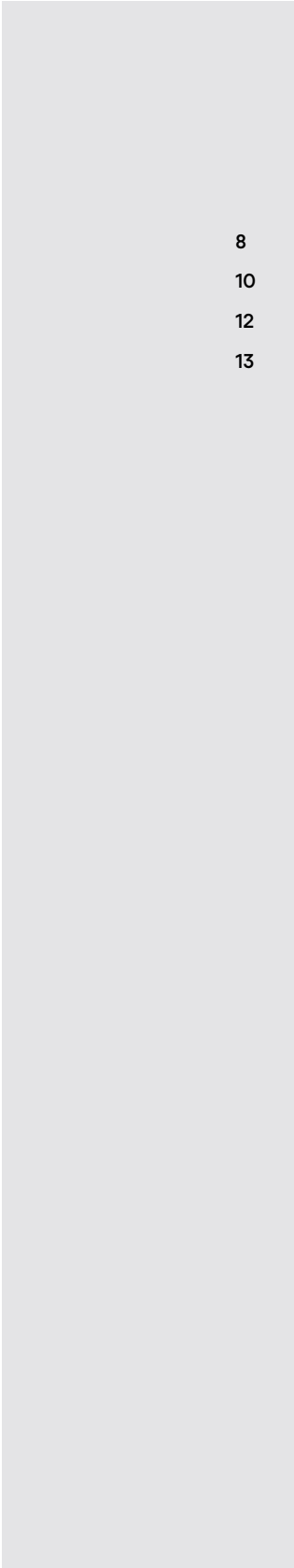

- 8 Terms and Conditions
- 10 Guaranteed Freight Program
- 12 Warranties
- 13 Care and Maintenance

## **GENERAL INFORMATION – *Terms and Conditions***

### **Prices**

Possession of this price list does not in itself constitute authority to sell and/or purchase product herein. All prices are LIST prices. Prices are effective with current date printed on the cover and supersede all other price lists. All accepted orders are subject to prevailing prices at time of order. WCI reserves the right to change prices or specifications without prior notice. Prices do not include tax or installation. Additional charges may apply on special requests for inside delivery.

### **Minimum Order**

WCI's minimum order is \$1,500 NET and orders under this amount will be subject to a \$150 service charge. .

### **Terms of Payment**

Payment terms will be established based on the credit rating and credit information provided by and for specific customers based on their credit application. WCI accepts payment via ACH transfer, wire transfer, check, or credit card (MasterCard, VISA, or American Express) Payments made via credit card will be assessed a 3% processing fee. Orders are invoiced at the time of shipment. Standard payment terms are 50% due at the time of order and 50% before shipment. Approved credit levels may be extended to thirty (30) days. All seating orders require a 50% deposit with the order, and the balance must be paid in full prior to the date of shipment or within net thirty (30) days with established credit. Past due accounts will be charged the lesser of 1-1/2% per month or the highest rate permitted by law, plus all collection costs, including reasonable attorney's fees and expenses.

### **Changes or Cancellations**

Any requested changes to or cancellation of an order must be submitted to WCI in writing. Approved change order requests may be subject to a revised production schedule and additional material and labor charges. Approved cancellation requests may be subject to restocking, material, and labor charges. Acknowledged orders for special, non-standard, and custom products cannot be canceled.

### **Storage**

WCI does not have a storage space for completed orders. If customer will not accept delivery of merchandise when products are ready, WCI will transfer products to a storage facility and products will be invoiced at that time. The customer is responsible for the storage charges and assumes and all risks associated with the storage of the product. Such storage shall be deemed delivery for all purposes including invoicing and payment. Customer will be responsible for arranging transfer of the product to its final destination.

## GENERAL INFORMATION – *Terms and Conditions*

### Orders

All orders must include WCI product model number, final material, and finish specifications for order entry. Send your orders directly to:

Postal Service or Courier Service:

West Coast Industries  
Attn: Order Entry  
361 N. Bernoulli Circle  
Oxnard, CA 93030

Email:

[order@westcoastindustries.com](mailto:order@westcoastindustries.com)

COM Upholstery Shipping Address:

West Coast Industries  
361 N, Bernoulli Circle  
Oxnard, CA 93030  
Phone: 800.446.1186  
\*Please side mark fabric with PO#

Duplicate orders that are received by mail (after being faxed or emailed) and not marked "confirmation" are the responsibility of the customer.

### **Acknowledgement**

All orders are manufactured and shipped according to the acknowledgement and its terms and conditions. It is the customer's responsibility to note any discrepancies on the acknowledgement and to notify WCI immediately. The printed acknowledgement constitutes the final agreement between the customer and WCI, thus superseding all previous communications regarding the order.

### **Designs and Specifications**

All designs and specifications are subject to change without prior notice. Any item or material may be discontinued without prior notice. All weights and dimensions are approximate.

## GENERAL INFORMATION — *Guaranteed Freight Program*

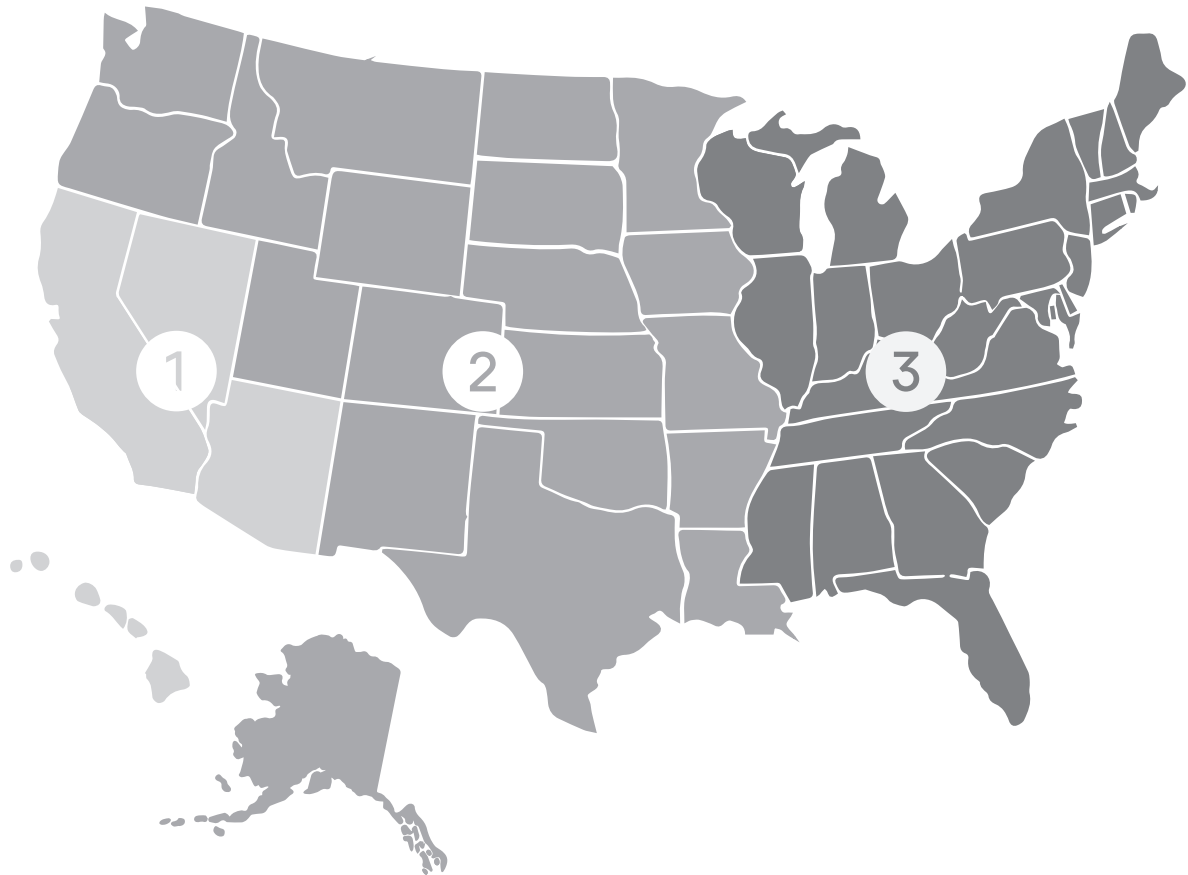

### Zone 1: Add 7%

Minimum freight charge of \$150.

Arizona, California, Hawaii\*, and Nevada.

### Zone 2: Add 9%

Minimum freight charge of \$275.

Alaska\*, Arkansas, Canada, Colorado, Idaho, Iowa, Kansas, Louisiana, Minnesota, Missouri, Montana, Nebraska, New Mexico, North Dakota, Oklahoma, Oregon, South Dakota, Texas, Utah, Washington, and Wyoming.

### Zone 3: Add 11%

Minimum freight charge of \$275.

Alabama, Connecticut, Delaware, District of Columbia, Florida, Georgia, Illinois, Indiana, Kentucky, Maine, Maryland, Massachusetts, Michigan, Mississippi, New Hampshire, New Jersey, New York, North Carolina, Ohio, Pennsylvania, Rhode Island, South Carolina, Tennessee, Vermont, Virginia, West Virginia, and Wisconsin.

\* Products shipped to Alaska\*, Hawaii\*, and Canada are F.O.B. factory, freight prepaid to port of embarkation, based on percentages as outlined above. The customer is responsible for freight charges from the port of embarkation to the final destination

**Note:** Guaranteed freight program applies to tables and outdoor furniture only. For upholstered furniture freight see Seating on page 13.

## GENERAL INFORMATION — *Guaranteed Freight Program*

### Tables and Outdoor

Tables and outdoor orders will be shipped F.O.B. factory. To calculate your guaranteed freight cost, refer to the map and zone matrix. Zone percentage is calculated based on standard discount from LIST, and pre-calculated fixed freight rate will be included on invoices. WCI reserves the absolute right to determine the method of shipping unless special delivery instructions have been previously approved. **Products shipped to Alaska\*, Hawaii\*, and Canada are F.O.B. factory, freight prepaid to port of embarkation, based on percentages as outlined above.** Customer is responsible for freight charges from port of embarkation to final destination

### Seating

Seating is not included in WCI's guaranteed freight program. WCI will negotiate discounted freight rates on the customer's behalf and will include those rates on the invoice. Seating is shipped F.O.B. factory, un-cartoned and blanket wrapped is standard, crating maybe provided and is available upon request, an additional charge may apply. WCI reserves the absolute right to determine the method of shipping unless special delivery instructions have been previously approved. **Products shipped to Alaska\*, Hawaii\*, and Canada are F.O.B. factory, freight prepaid to port of embarkation, based on percentages as outlined above.** Customer is responsible for freight charges from port of embarkation to final destination

### Freight Claims

West Coast Industries will file freight claims on behalf of our customer . Damage to product and or cartons MUST be noted on the proof of delivery ( POD )receipt. Failure to notify or document the damage within five business days will constitute acceptance of merchandise and waiver of any defects, shortages, or errors found upon inspection. Pictures of product and or packaging must be sent to your customer service representative to initiate a freight claim and replacement or repair. **No claim will be accepted for concealed damage without being noted on the POD.**

### Normal Delivery

Normal delivery is on a dock to dock basis. Special requests, such as inside delivery, "call before," etc, should appear on the customer's purchase order and are subject to additional charges. Every attempt will be made by WCI to accommodate customers' requests. Delivery date is subject to strikes, accidents, availability of supplies, and any other causes beyond our control. WCI may stop and/or hold shipment if payment terms, account status, or credit are not satisfactory.

### Will Call

Customers may choose to pick up orders at our factory. Customers will be notified when their order is ready for orders marked "will call." Pick up must be made within five business days. If order is not picked up within five business days reference Storage policy on page 8. Customer pick up is available between 8 AM and 2 PM PST. Please call WCI customer service at **213.627.1113 ex.223** to schedule a customer pick-up.

## GENERAL INFORMATION – *Warranties*

### Tables

All tables manufactured by WCI are warranted to the original purchaser covering normal usage for a period of **twelve years** from the date of the original invoice. WCI will replace or repair (at our discretion) without cost to our customers any item found to be defective as a result of defective materials or workmanship. We will not, however, repair any item which has been abused or subjected to any use other than that which was originally intended for our product. Any repairs by the customer must receive specific written authorization from WCI before being executed on location to receive proper reimbursement for associated costs. In no event shall liability under this warranty exceed the original purchase price.

Electrical items not manufactured by WCI are covered for a period of one year.

Plastic laminates, Corian®, quartz and non-standard custom materials are not warranted by WCI, but are warranted by the respective manufacturers under their specific warranty only.

Wood furniture is made of natural variable raw material. Differences in grain characteristics and color among wood species are naturally occurring variations and are not within the control of WCI nor considered defects included in this warranty.

### Seating

WCI seating frames are warranted to be free of defects in materials and workmanship covering normal usage to the original purchaser for a period of **seven years** from the date of the original invoice. WCI will replace or repair (at our discretion), without cost to our customers, any item found to be defective as a result of defective material or workmanship. This warranty does not apply to damage resulting from accident, misuse, abuse, alteration or negligence. Any repairs by the customer must receive specific written authorization from WCI before being executed on location to receive proper reimbursement for associated costs. WCI will not be liable for any additional charges sustained by the customer because of improper installation by others, usage or after market additions.

Plastic laminates, upholstery and non-standard custom materials are not warranted by WCI, but are warranted by the respective manufacturers under their specific warranty only.

Wood furniture is made of natural variable raw material. Differences in grain characteristics and color among wood species are naturally occurring variations and are neither within the control of WCI, nor considered defects included in this warranty.

WCI seating is not intended for outdoor usage. Outdoor usage of seating voids warranty.

COM textiles and COL leathers are not warranted by WCI, but are warranted by the respective manufacturers under their specific warranty only.

### Outdoor

All outdoor products manufactured by WCI are warranted to the original purchaser covering normal usage for a period of **one year** from the date of the original invoice. WCI will replace or repair (at our discretion) without cost to our customers any item found to be defective as a result of defective material or workmanship. We will not, however, repair any item which has been abused or subjected to any use other than that which was originally intended for our product. Any repairs by the customer must receive specific written authorization from WCI before being executed on location to receive proper reimbursement for associated costs. In no event shall liability under this warranty exceed the original purchase price.

## GENERAL INFORMATION – *Care and Maintenance*

### Table Tops

#### Plastic Laminate Table Tops

Laminate topped tables be cleaned with a mild, non-abrasive cleaner and cloth.

Formica®: [www.formicadocs.info/en-us/search#sort=relevancy&f:DocumentSiteType=\[Technical%20Guides\]](http://www.formicadocs.info/en-us/search#sort=relevancy&f:DocumentSiteType=[Technical%20Guides])

Nevamar®: [www.panolam.com/wp-content/uploads/2020/06/Panolam-Surface-Systems-Care-and-Maintenance-HPL-2-2018.pdf](http://www.panolam.com/wp-content/uploads/2020/06/Panolam-Surface-Systems-Care-and-Maintenance-HPL-2-2018.pdf)

Pionite®: [www.style-ritekitchens.com/wp-content/uploads/2013/11/Pionite-Care-and-Maintenance.pdf](http://www.style-ritekitchens.com/wp-content/uploads/2013/11/Pionite-Care-and-Maintenance.pdf)

Wilsonart®: [www.wilsonart.com/media/Technical\\_Resources/en/hpl\\_cm.pdf](http://www.wilsonart.com/media/Technical_Resources/en/hpl_cm.pdf)

#### Wood Veneer and Solid Wood Table Tops

Wood must be treated as a breathing, living material. Like all organisms, it is subject to changes depending upon the environment in which it exists. The principal concern is the humidity in the surrounding atmosphere and its effect on the wood. Like many other materials, wood shrinks when it loses moisture and it swells when it absorbs it. WCI wood finishes should be wiped clean with a soft damp cloth moistened with water, and then dried with a soft cloth. Wood finishes should be protected from excessive heat. A heat pad, coaster or trivet should be used to protect the table top from pots, pans, hot serving dishes, drinks, plates, etc.

**Note:** Do not use commercial cleaners, abrasives, solvents, Windex, 409, Ajax, etc. on the table top as this will wear away the acrylic waterborne enamel.

#### Corian® Table Tops

Please see: [www.corian.com/IMG/pdf/k-26840-corian-solid-surface-care-and-maintenance.pdf](http://www.corian.com/IMG/pdf/k-26840-corian-solid-surface-care-and-maintenance.pdf)

#### Quartz Table Tops

Caesarstone®: [www.caesarstoneus.com/care-maintenance/quartz-surfaces/](http://www.caesarstoneus.com/care-maintenance/quartz-surfaces/)

Okite® : [us.okite.com/resources/](http://us.okite.com/resources/)

#### Metal Tables Tops

All metal tables are suitable for indoor and outdoor applications. They have been pretreated and powder coat finished to resist the elements all year long without fading, rusting, or cracking.

For regular cleaning of the metal frames, use a solution of mild, non-abrasive soap and warm water. For more difficult stains, use a mild household cleaner. Avoid using abrasives and chemical cleaners. Always test a small area prior to cleaning. Do not pressure wash.

### Table Bases

#### Powder Coat and Plated Bases

All powder coat and plated bases should be cleaned with a mild, non-abrasive cleaner and cloth. Users are urged to make periodic inspections to look for damage, loose screws and bolts, or other signs of structural fatigue incurred in daily handling, use, and abuse. Examination must include structural joints, corner blocks, welds, and any other stress points. Any product found to be damaged, defective or loose should be taken out of service immediately

## General Maintenance

Our customers are urged to make periodic inspections to look for damage, loose screws and bolts or other signs of structural fatigue incurred in daily use. Examination must include structural joints, corner blocks, welds and any other stress points. Any product found to be damaged, defective or loose should be taken out of service immediately.



# Product Specifications

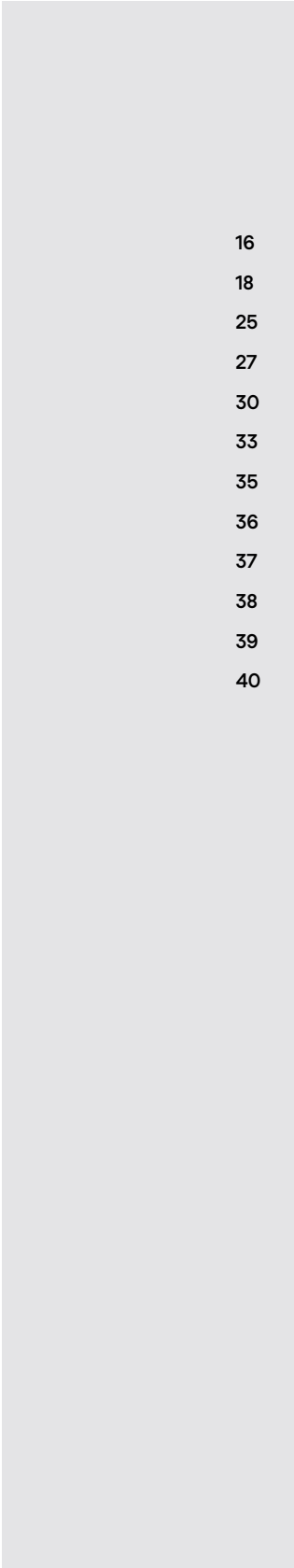

- 16 How to Order a Table
- 18 Bases Specifications
- 25 Tops Specifications
- 27 Edge Profiles
- 30 Material and Finish Codes
- 33 Laminate Reference Guide
- 35 Solid Surface Reference Guide
- 36 Quartz Reference Guide
- 37 Wood Grain and Patterns
- 38 Grommet Locations
- 39 ADA Tables
- 40 Seating Specifications

# PRODUCT SPECIFICATIONS – How to Order a Table

**DI36RDLWFLLDWWNMMBM** This model number represents a table with a Disc series matte black powder coat base, a 36" round 1.25" thick laminate top in Designer White, with a .125" flat wood edge profile in Natural Maple.

**40AH** The table options specify an alternate height base with a 40" overall table height.

### Table Model Number

Select your table model number which includes the base series and style, top size, top shape, top material and edge profile style and base finish.

**DI36RDLWFLLDWWNMMBM**

**Base Series and Style Code (DI)**

Disc base

**Top Size Code (36)**

36" diameter top

**Table Shape Code (RD)**

Round top

**Top Material & Edge Profile Code (LWFL)**

Laminate top with flat wood edge

**Top Finish Code (LDW)**

Laminate Designer White

**Edge Finish Code (WNM)**

Wood natural maple

**Base Finish Code (MBM)**

Matte black powder coat

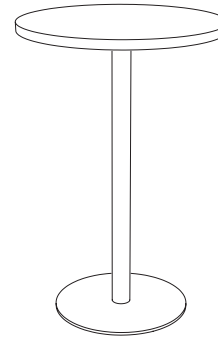
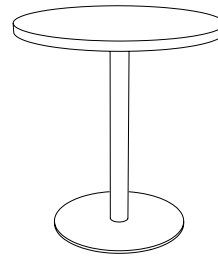

### Options

Specify your options

**40AH**

**Alternate Height (40AH)**

Alternate height base (with a 40" overall table height)



# PRODUCT SPECIFICATIONS – Tables

## DINING & MULTIPURPOSE

BA

Basic Round

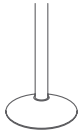

**Standard Base Height:** 28"  
**Base:** 14", 17", 20", 22" & 28" diameter cast iron, also available with decorative steel cover plate for powder coating and plating. (L=light, M=medium, H=heavy weight)  
**Column:** 3", 3.5" or 6" diameter, steel tubing  
**Top Plate:** 7.625" or 15" square steel  
**Standard Glide:** Nylon octagon (GNO)  
**Standard Finish:** Cast iron in black texture (MBT)  
**Optional Finishes:** Powder coated & Plated

BR

Brae

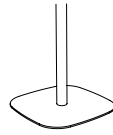

**Standard Base Height:** 28"  
**Column:** 2", 2.5" or 3" diameter, steel tubing  
**Top Plate:** 6" SQ Flat, 10" SQ Flat & 19" Spider steel  
**Standard Glide:** White nylon carpet glide (GNC)  
**Standard Finish:** Powder coated  
**Optional Finish:** Plated & Stainless Steel

BL

Blok

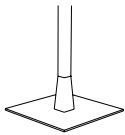

**Standard Base Height:** 28"  
**Base:** 18", 22", 26" in 0.375" thick square plates  
**Column:** 2", 2.5", or 3" square steel  
**Wood Element:** 2", 2.5" or 3" square in Oak, Walnut & Maple. Available in all 14 stains (Cherry stains are over Maple)  
**Top Plate:** 6" SQ Flat, 10" SQ Flat & 19" Spider  
**Standard Glide:** White nylon carpet glide (GNC)  
**Standard Finish:** Powder Coat  
**Optional Finish:** Plated & Stainless Steel

BRD

Brae Double

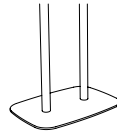

**Standard Base Height:** 28"  
**Base:** 18" x 26" .375" thick steel plate  
**Column:** 2" round steel tubing  
**Top Plate:** 10" SQ Flat  
**Standard Glide:** White nylon carpet glide (GNC)  
**Standard Finish:** Powder coated  
**Optional Finish:** Plated & Stainless Steel

JB

Bolt Down



(JB) J Bolt-down Base  
**Standard Base Height:** 28"  
**Floor Plate:** 6.75" diameter steel with four .375" diameter holes; fasteners to attach base to floor are not included.  
**Cover Plate:** 8" diameter steel, finish to match column  
**Column:** 3" diameter, steel tubing  
**Top Plate:** 7.625" square steel  
**Standard Finish:** Powder coated  
**Optional Finish:** Plated

CA

Canvas



**Overall Table Height:** 29"  
**Legs:** 2.5" x 2.5" plywood  
**Apron:** 2.5" high  
**Legs & Apron:** Laminate or wood veneer  
**Top:** Laminate or wood veneer  
**Overlay:** Corian® & Quartz  
**Clad:** Corian®  
**Standard Glide:** Nickel plated glide (GNP)

All table bases are assembled, level checked, and cartoned. Vista table collection is shipped KD.

# PRODUCT SPECIFICATIONS – Tables

## DINING & MULTIPURPOSE

DI

Disc

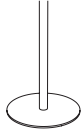

**Standard Base Height:** 28"  
**Base:** 18", 22" & 26" diameter .375" thick steel plate  
**Column:** 2", 2.5" or 3" diameter, steel tubing  
**Top Plate:** 6" SQ Flat, 10" SQ Flat & 19" Spider steel  
**Standard Glide:** White nylon carpet glide (GNC)  
**Standard Finish:** Powder coated  
**Optional Finish:** Plated & Stainless Steel

KO

Kone

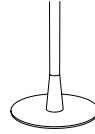

**Standard Base Height:** 28"  
**Base:** 18", 22", 26" 0.375" thick round plates  
**Column:** 2", 2.5" or, 3" round Steel  
**Wood Element:** 2", 2.5" or 3" round in Oak, Walnut & Maple. Available in all 14 stains (Cherry stains are over Maple)  
**Top Plate:** 6" SQ Flat, 10" SQ Flat & 19" Spider  
**Standard Glide:** White nylon carpet glide (GNC)  
**Standard Finish:** Powder Coat  
**Optional Finish:** Plated & Stainless Steel

DU

Dunhill

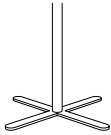

**Standard Base Height:** 28"  
**Base:** 18", 24", 30" & 36" X-base configurations, 18", 24" & 30" T-base configurations with a single column. Double column T-bases are available 30" or 36" wide, .5" x 2.5" solid steel bar  
**Column:** 2", 2.25", 3" or 3.25" diameter, steel tubing  
**Top Plate:** 7.625", 10.75" or 15" square steel  
**Standard Glide:** Nylon octagon (GNO)  
**Standard Finish:** Powder coated  
**Optional Finish:** Plated & Stainless Steel

MOV

Move



**Overall Table Height:** 25"  
**Dimensions:** 18" Depth, 13" Width, 15" Width  
**Top:** Laminate (available in 7 finishes) or wood veneer  
**Standard Glide:** 2.25" Round Teflon Glide  
**Standard Finish:** Powder coated  
**Optional Finish:** Plated (polished not available)

FR

Flat Round

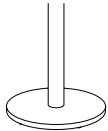

**Standard Base Height:** 28"  
**Base:** 18", 22" & 26" diameter cast iron with decorative steel cover plate  
**Column:** 3", 3.5" or 6" diameter, steel tubing  
**Top Plate:** 7.625", 10.75" or 15" square steel  
**Standard Glide:** Nylon octagon (GNO)  
**Standard Finish:** Powder coated  
**Optional Finish:** Plated & Stainless Steel

PA

Parsons

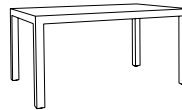

**Overall Table Height:** 29"  
**Legs:** 2.5" x 2.5" solid lumber  
**Apron:** 2.5" high  
**Legs & Apron:** Laminate or wood  
**Top:** Laminate or wood veneer  
**Standard Glide:** Nickel plated glide (GNP)

All table bases are assembled, level checked, and cartoned. Vista table collection is shipped KD.

# PRODUCT SPECIFICATIONS – Tables

## DINING & MULTIPURPOSE

**PL Platform**



**Standard Base Height:** 28"  
**Base:** 18", 22" & 26" square .375" thick steel plate  
**Column:** 2" SQ, 2.5" SQ or 3" SQ steel tubing  
**Top Plate:** 6" SQ Flat, 10" SQ Flat & 19" Spider steel  
**Standard Glide:** White nylon carpet glide (GNC)  
**Standard Finish:** Powder coated  
**Optional Finish:** Plated & Stainless Steel

**PO Post Leg**



**Standard Base Height:** 28"  
**Leg:** 1.5", 2.5" or 3" diameter steel tubing  
**Top Plate:** 4.25" or 6" square steel  
**Standard Glide:** Nickel plated with white nylon bottom (GNN)  
**Standard Finish:** Powder coated  
**Optional Finish:** Plated

**PLD Platform Double**



**Standard Base Height:** 28"  
**Base:** 18" x 26" .375" thick steel plate  
**Column:** 2" square steel tubing  
**Top Plate:** 10" SQ Flat  
**Standard Glide:** White nylon carpet glide (GNC)  
**Standard Finish:** Powder coated  
**Optional Finish:** Plated & Stainless Steel

**RG Regency**

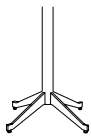

**Standard Base Height:** 28"  
**Base:** 18", 24", 30" X-base configurations, .5" solid steel, tapering from 2.5" high to 1.25" high. 36" & 48" X-base configurations, 1" solid steel, tapering from 3" high to 1.25" high. 21" x 42" & 24" x 48" scissor-base configurations, 1" solid steel, tapering from 3" high to 1.25" high.  
**Column:** 2.5" or 3.5" diameter steel tubing  
**Top Plate:** 7.625" or 15" square steel, 15" x 24" & 18" x 36" flat iron  
**Standard Glide:** Nickel plated glide (GNP)  
**Standard Finish:** Powder coated  
**Optional Finish:** Plated

**PU Plus**

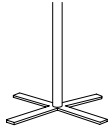

**Standard Base Height:** 28"  
**Base:** 18", 24", 30" & 36" X-base configurations, 18", 24" & 30" T-base configurations with a single column. Double column T-bases are available 30" or 36" wide, .5" x 2.5" solid steel bar  
**Column:** 2", 2.25", 3" or 3.25" diameter, steel tubing  
**Top Plate:** 7.625", 10.75" or 15" square steel  
**Standard Glide:** Nylon octagon (GNO)  
**Standard Finish:** Powder coated  
**Optional Finish:** Plated & Stainless Steel

**TL Tulip**

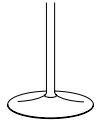

**Standard Base Height:** 28"  
**Base:** 18" or 24" diameter (L=light, M=medium, H=heavy, XH=extra heavy weight) cast iron with decorative steel cover plate.  
**Column:** 2" or 2.25" diameter, steel tubing  
**Top Plate:** 7.625", 10.75" or 15" square steel  
**Standard Glide:** Nylon Octagon (GNO)  
**Standard Finish:** Powder coated  
**Optional Finish:** Plated & Stainless Steel

**VS Vista**



**Overall Table Heights:** 29", 36" & 42"  
**Legs:** 2" x 2.5" Square steel tubing  
**Top:** Laminate, wood veneer, Corian®, Quartz  
**Glide:** Nickel plated glide (GNP)

All table bases are assembled, level checked, and cartoned. Vista table collection is shipped KD.

# PRODUCT SPECIFICATIONS – Tables

## OCCASIONAL

BL

**Blok**

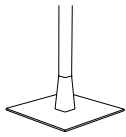

**Standard Base Height:** 16", 18", 20"  
**Base:** 14" in 0.25" thick & 18", 22" in 0.375" thick square plates  
**Column:** 1.5", 2" square steel  
**Wood Element:** 1.5", 2" square in Oak, Walnut & Maple. Available in all 14 stains (Cherry Stains over Maple)  
**Top Plate:** 6", 10" SQ Flat  
**Standard Glides:** 2.25" Round Teflon Glide or Carpet Glides (GNC)  
**Standard Finish:** Powder Coat  
**Optional Finish:** Plated & Stainless Steel

CY

**Cylinder**

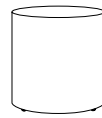

**Overall Table Heights:** 16", 18", 20" & 24"  
**Material:** Laminate or wood construction  
**Overlay:** Corian® & Quartz  
**Standard Glide:** Nickel plated glide (GNP)

BR

**Brae**

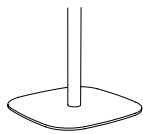

**Occasional Base Heights:** 16", 18" or 20"  
**Base:** 18" & 22" diameter .375" thick steel plate  
**Column:** 1.5", 2" diameter, steel tubing  
**Top Plate:** 6" SQ Flat, 10" SQ Flat steel  
**Standard Glide:** White nylon carpet glide (GNC)  
**Standard Finish:** Powder coated  
**Optional Finish:** Plated & Stainless Steel

DI

**Disc**

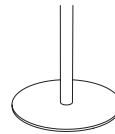

**Occasional Base Heights:** 16", 18" or 20"  
**Base:** 18" & 22" diameter .375" thick steel plate  
**Column:** 1.5", 2" diameter, steel tubing  
**Top Plate:** 6" SQ Flat, 10" SQ Flat steel  
**Standard Glide:** White nylon carpet glide (GNC)  
**Standard Finish:** Powder coated  
**Optional Finish:** Plated & Stainless Steel

CU

**Cube**

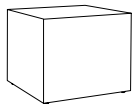

**Overall Table Heights:** 16", 18", 20" & 24"  
**Material:** Laminate or wood construction  
**Overlay:** Corian® & Quartz  
**Standard Glide:** Nickel plated glide (GNP)

All table bases are assembled, level checked, and cartoned. Vista table collection is shipped KD.

# PRODUCT SPECIFICATIONS – Tables

## OCCASIONAL

KO

Kone

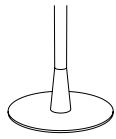

**Occasional Base Heights:** 16", 18", 20"  
**Base:** 14" in 0.25" thick & 18", 22" in 0.375" thick round pates  
**Column:** 1.5", 2" round steel  
**Wood Element:** 1.5", 2" round in Oak, Walnut & Maple. Available in all 14 stains (Cherry Stains over Maple)  
**Top Plate:** 6", 10" SQ Flat  
**Standard Glide:** 2.25" Round Teflon Glide or Carpet Glides (GNC)  
**Standard Finish:** Powder Coat  
**Optional Finish:** Plated & Stainless Steel

PL

Platform

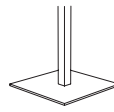

**Occasional Base Heights:** 16", 18" or 20"  
**Base:** 18" & 22" square .375" thick steel plate  
**Column:** 1.5" SQ or 2" SQ steel tubing  
**Top Plate:** 6" SQ Flat, 10" SQ Flat steel  
**Standard Glide:** White nylon carpet glide (GNC)  
**Standard Finish:** Powder coated  
**Optional Finish:** Plated & Stainless Steel

MOV

Move



**Overall Table Height:** 25"  
**Dimensions:** 18" Depth, 13" Width, 15" Width  
**Top:** Laminate, wood veneer, Corian®  
**Standard Glide:** 2.25" Round Teflon Glide  
**Standard Finish:** Powder coated  
**Optional Finish:** Plated (polished not available)

TR

Triad



**Occasional Base Heights:** 16", 18" or 20"  
**Base:** Ash solid lumber  
**Top:** Laminate, wood veneer, Corian®  
**Standard Glide:** .75" round nail on Nylon carpet glide  
**Standard Finish:** Powder coated  
**Optional Finish:** Plated & Stainless Steel

PA

Parsons

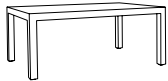

**Overall Occasional Table Heights:** 16", 18", 20", 24"  
**Legs:** 2.5" x 2.5" solid lumber  
**Apron:** 2.5" high  
**Material:** Laminate or wood construction  
**Standard Glide:** Nickel plated glide (GNP)

All table bases are assembled, level checked, and cartoned. Vista table collection is shipped KD.

# PRODUCT SPECIFICATIONS – Tables

## OUTDOOR TABLES

**BA** **Basic Round**

---



**Standard Base Height:** 28"  
**Base:** 14", 17", 20", 22" & 28" diameter cast iron, also available with decorative steel cover plate for powder coating (L=light, M=medium, H=heavy weight)  
**Column:** 3", 3.5" or 6" diameter, steel tubing  
**Top Plate:** 7.625" or 15" square steel  
**Standard Glide:** Superlevel glide (GSL)  
**Standard Finish:** Cast iron in black texture (MBT)  
**Optional Finish:** Powder coated

**FR** **Flat Round**

---



**Standard Base Height:** 28"  
**Base:** 18", 22" & 26" diameter cast iron with decorative aluminum cover plate  
**Column:** 3" or 6" diameter, aluminum tubing  
**Top Plate:** 7.625", 10.75" or 15" square steel  
**Standard Glide:** Superlevel glide (GSL)  
**Standard Finish:** Powder coated  
**Optional Finish:** Anodized Aluminum, Stainless Steel

**BR** **Brae**

---

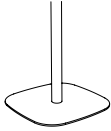

**Standard Base Height:** 28"  
**Base:** 18", 22" & 26" RD square .375" thick steel plate  
**Column:** 2", 2.5" or 3" diameter, steel tubing  
**Top Plate:** 6" SQ Flat, 10" SQ Flat, & 19" Spider steel  
**Standard Glide:** Nylon octagon (GNO)  
**Standard Finish:** Powder coated  
**Optional Finish:** Stainless Steel

**PL** **Platform**

---



**Standard Base Height:** 28"  
**Base:** 18", 22" & 26" square .375" thick steel plate  
**Column:** 2" SQ, 2.5" SQ or 3" SQ steel tubing  
**Top Plate:** 6" SQ Flat, 10" SQ Flat & 19" Spider steel  
**Standard Glide:** Black octagon (GNO)  
**Standard Finish:** Powder coated  
**Optional Finish:** Stainless Steel

**DI** **Disc**

---

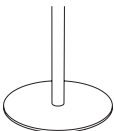

**Standard Base Height:** 28"  
**Base:** 18", 22" & 26" diameter .375" thick steel plate  
**Column:** 2", 2.5" or 3" diameter, steel tubing  
**Top Plate:** 6" SQ Flat, 10" SQ Flat, & 19" Spider steel  
**Standard Glide:** Nylon octagon (GNO)  
**Standard Finish:** Powder coated  
**Optional Finish:** Stainless Steel

**PLD** **Platform Double**

---

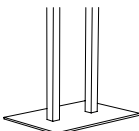

**Standard Base Height:** 28"  
**Base:** 18" x 26" .375" thick steel plate  
**Column:** 2" square steel tubing  
**Top Plate:** 10" SQ Flat  
**Standard Glide:** Black octagon (GNO)  
**Standard Finish:** Powder coated  
**Optional Finish:** Stainless Steel

**BRD** **Brae Double**

---

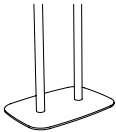

**Standard Base Height:** 28"  
**Base:** 18" x 26" .375" thick steel plate  
**Column:** 2" diameter, steel tubing  
**Top Plate:** 10" SQ Flat  
**Standard Glide:** Nylon octagon (GNO)  
**Standard Finish:** Powder coated  
**Optional Finish:** Stainless Steel

All table bases are assembled, level checked, and cartoned. Vista table collection is shipped KD.

# PRODUCT SPECIFICATIONS – Tables

## OUTDOOR TABLES

VS

Vista



Overall Table Heights: 29", 36" & 42"  
Legs: 2" or 2.5" square steel tubing  
Top: Laminate, wood veneer, Corian®, Quartz  
Standard Glide: Nickel plated glide (GNP)

TL

Tulip

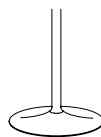

Standard Base Height: 28"  
Base: 18" or 24" diameter (L=light, M=medium, H=heavy, XH= extra heavy weight) cast iron with decorative steel cover plate  
Column: 2" or 2.25" diameter, steel tubing  
Top Plate: 7.625", 10.75" or 15" square steel  
Standard Glide: Superlevel glide (GSL)  
Standard Finish: Powder coated  
Optional Finish: Stainless Steel

All table bases are assembled, level checked, and cartoned. Vista table collection is shipped KD.

## PRODUCT SPECIFICATIONS – *Tops*

### Laminate Top Construction

Standard 1.25" thick core material, consisting of a NAUF Particle Board (45.5 lb/ft<sup>3</sup>), MDF (46 lb/ft<sup>3</sup>), or 1" thick Birch Plywood (40 lb/ft<sup>3</sup>) core, surfaced with a laminate face. The core material is determined by the specified edge profile. A phenolic backer is used on the underside of the top. All complete tables (consisting of a top and base) have steel threaded inserts for metal-to-metal mounting of the top to the base, allowing ease of installation. Tops sold separately do not have steel threaded inserts. Table tops over 96" in length have steel support to prevent bowing. All top dimensions are nominal and may vary up to 0.75", depending on the edge treatment. If a critical size is required ( $\pm 0.0625$ "), dimensions should be specified in writing.

### Wood Veneer Top Construction

Standard 1.25" thick core material, consisting of a NAUF Particle Board (45.5 lb/ft<sup>3</sup>), MDF (46 lb/ft<sup>3</sup>), or 1" thick Birch Plywood (40 lb/ft<sup>3</sup>) core, surfaced with a book matched veneer face. A phenolic backer is used on the underside of the top. All complete tables (consisting of a top and base) have steel threaded inserts for metal-to-metal mounting of the top to the base, allowing ease of installation. Tops sold separately do not have steel threaded inserts. Table tops over 96" in length have steel support to prevent bowing. All top dimensions are nominal and may vary up to 0.75", depending on the edge treatment. If a critical size is required ( $\pm 0.0625$ "), dimensions should be specified in writing.

### Butcherblock Top

Butcher Block Tops have an eased edge with 1-5/16" (1.3125") to 1-11/16" (1.6875") wide finger jointed strips, and are 10" to 24" long. Tops are 1.375" thick and 1.875" thick on 60" and 72" tops. Tops are constructed from solid maple and have 0.75" tolerance.

### Wood Surface Finish

All wood products are finished in acrylic waterborne enamel providing a 10-20% sheen finish using a multi-step process of hand sanding, staining, and sealing that provides superior water and alcohol resistance. Custom sheens are available upon request; please contact WCI Customer Service for a quote.

### Solid Surface

#### Corian® Surfaces

Standard 1"x1" thick built-up edge on 0.5" thick Corian® (106.1 lb/ft<sup>3</sup>) with a wood sub-top. Fabricated out of a 0.75" plywood sub-top for indoor and outdoor use, finished in standard white paint. Corian® is a solid surface material from DuPont composed of 33% of Poly Methyl Methacrylate and 67% of Natural Minerals like Alumina Trihydrate. Corian®, along with its adhesives and sealants, are certified by GREENGUARD®, providing a complete surfacing system with low amounts of VOC (volatile organic compounds). All top dimensions are nominal and may vary up to 0.75" depending on the edge treatment. If a critical size is required ( $\pm 0.0625$ "), dimensions must be specified in writing.

#### Quartz Surfaces

Standard 0.75" thick material construction with 0.75" marine grade plywood sub-top for indoor use only. Quartz is comprised of a blend of 93% quartz and 7% polyester that is processed into slabs using a vibro-compression vacuum process. If your project entails more material than a manufactured slab, one or more seams will be required. The product is certified according to the GREENGUARD® Indoor Air Quality Certification Program for Low Emitting Products. As a non-porous material, it will not harbor bacteria and is stain resistant. It is very dense, making it impact and scratch resistant. The sub-top is painted to match the quartz top and is sized such that it is inset by 3" from the edge of the top. All top dimensions are nominal and may vary up to 0.75" depending on edge treatment. If a critical size is required ( $\pm 0.125$ "), dimensions should be specified in writing.

## PRODUCT SPECIFICATIONS – *Tops*

### **Vinyl T-Mold Edges**

Vinyl edges provide an impact-resistant edge. All vinyl T-molding corners have a 2" radius.

### **PVC Edges**

PVC edges provide an impact-resistant edge. PVC corners are 90° square, rounded corners are a 3" radius minimum.

### **Wood Edges**

Wood edges are offered in solid ash, maple, rift cut oak, cherry, and walnut. Other wood species are available upon request; please contact WCI Customer Service for a quote.

### **Overall Table Heights**

Overall table heights vary according to top specification. WCI's standard base only height is 28" . Add top thickness to determine overall table height. Canvas and Parsons are standard at 29 overall height. For alternate height (AH) tables, the height specification refers to the overall height of the table when ordering a complete table, or the overall height of the base when ordering base only.

# PRODUCT SPECIFICATIONS – Edge Profiles

## SELF EDGE

LLSE

### Self Laminate Edge

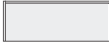

1.25" thick edge  
Edge is banded with matching standard grade top plastic laminate  
Square and rectangle tops standard with square corners  
Available on 1.25" thick top  
Available in 19 standard laminates

## VINYL EDGES

LVFL

### Flat Vinyl T-Mold Edge

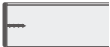

.125" x 1.25" flat vinyl edge  
Square and rectangle tops standard with 2" radius corners  
Available on 1.25" thick top  
Available in 12 colors

LVBP

### Bumper Vinyl T-Mold Edge

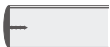

.1875" x 1.25" rounded vinyl bumper edge  
Square and rectangle tops standard with 2" radius corners  
Available on 1.25" thick top  
Available in 12 colors

## PVC EDGE

LPVC

### Flat PVC Edge

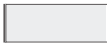

.125" x 1.25" flat pvc edge  
Square and rectangle tops standard with square corners Available on 1.25" thick top  
Available in 12 colors

## WOOD EDGES GROUP A

LW = Laminate top with a wood edge available in 19 standard laminates  
WW = Wood top with a wood edge available in 5 wood species and 20 stains

LWFL & WWFL

### Flat Wood Edge



.125" thick flat wood edge, eased corners  
Square and rectangle tops standard with square corners  
Available on 1.25" thick top  
Available in 5 wood species and 20 stains

LWTP & WWTP

### Tapered Ply Edge



1" thick exposed Baltic Birch plywood edge with a reverse beveled tapered profile  
Square and rectangle tops standard with square corners  
Available on 1" thick top

LWFP & WWFP

### Flat Ply Edge



1" thick exposed Baltic Birch plywood edge with a flat profile  
Square and rectangle tops standard with square corners  
Available on 1" thick top

## WOOD EDGES GROUP B

LW = Laminate top with a wood edge available in 19 standard laminates  
WW = Wood top with a wood edge available in 5 wood species and 20 stains

LWSQ & WWSQ

### Square Wood Edge



1.25" x 1.25" flat square wood edge  
Square and rectangle tops standard with square corners  
Available on 1.25" thick top  
Available in 5 wood species and 20 stains

LWBN & WWBN

### Bullnose Wood Edge



1.25" x 1.25" bullnose wood edge  
Square and rectangle tops standard with square corners Available on 1.25" thick top  
Available in 5 wood species and 20 stains

LWPR & WWPR

### Prism Wood Edge



1.25" x 1.25" prism wood edge  
Square and rectangle tops standard with square corners  
Available on 1.25" thick top  
Available in 5 wood species and 20 stains

# PRODUCT SPECIFICATIONS – Edge Profiles

## BUTCHER BLOCK EDGES

**BBFL**

**Butcher Block Flat Edge**



1.3125" finger jointed strips x 1.375" thick, 1.875" thick on 60" diameter tops only  
Square and rectangle tops standard with square corners  
Available on 1.375" thick top  
Available in Maple and 3 stains

**BBBN**

**Butcher Block Bullnose Edge**



1.3125" finger jointed strips x 1.375" thick, 1.875" thick on 60" diameter tops only  
Square and rectangle tops standard with .5" radius corners  
Available on 1.375" thick top  
Available in Maple and 3 stains

## CORIAN® EDGES

**C1FL & C2FL**

**Corian® Flat Edge**

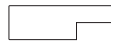

.5" thick Corian® material with 1" thick edge  
Square and rectangle tops standard with .125" radius corners  
Available in 8 colors

**C1BN & C2BN**

**Corian® Bullnose Edge**



.5" thick Corian® material with 1" thick edge  
Square and rectangle tops standard with .5" radius corners  
Available in 8 colors

**C1PR & C2PR**

**Corian® Prism Edge**



.5" thick Corian® material with 1" thick edge  
Square and rectangle tops standard with square corners  
Available in 8 colors

## QUARTZ EDGES

**Q1FL & Q2FL**

**Quartz Flat Edge**



.75" thick material  
With .75" painted plywood subtop, 3" inset from edge  
Square and rectangle tops with standard square corners  
Available in 7 colors

**Q1BN & Q2BN**

**Quartz Bullnose Edge**



.75" thick material  
With .75" painted plywood subtop, 3" inset from edge  
Square and rectangle tops with standard square corners  
Available in 7 colors

## FACET EDGES – BLOK & KONE TABLES

**LFSE**

**Facet Self Edge**



1.25" thick facet edge  
Square and rectangle tops with standard square corners  
Available on 1.25" thick top  
Available in 19 standard laminates

**WVFC**

**Veneer Facet Self Edge**



1.25" thick facet edge  
Square and rectangle tops with standard square corners  
Available on 1.25" thick top  
Available in 5 wood species and 20 stains

**WWFC**

**Wood Facet Edge**



1.25" x 1.25" thick facet wood edge  
Square and rectangle tops with standard square corners  
Available in 1.25" thick tops  
Available in 5 wood species and 20 stains

**C0FC**





**Corian® Facet Edge**



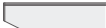

.5" Corian® with 1" thick edge  
Square and rectangle tops with standard square corners  
Available on 1" thick top  
Available in 8 finishes

# PRODUCT SPECIFICATIONS – Edge Profiles



## OCCASIONAL TABLES – FACET EDGES

<b>LFCT</b>	<b>Facet Ply Edge</b>
	<p>1" thick facet edge                  Square and rectangle tops with standard square corners                  Available on 1" thick top                  Available in 19 standard laminates</p>
<b>LMFC</b>	<b>Mini-Facet Ply Edge</b>
	<p>.5" thick facet edge                  Square tops with standard square corners                  Available in .5" thick top                  Available in 19 laminate finishes</p>
<b>WFCT</b>	<b>Veneer Occasional Facet Edge</b>
	<p>1" thick facet edge                  Square and rectangle tops with standard square corners                  Available on 1" thick top                  Available in 5 wood species and 20 stains</p>
<b>WMFC</b>	<b>Mini Veneer Facet Self Edge</b>
	<p>.5" thick wood edge                  Square and rectangle tops with standard square corners                  Available in 5 wood species and 20 stains</p>
<b>C1FM &amp; C2FM</b>	<b>Mini Corian® Facet Edge</b>
	<p>.5" Corian® with .5" thick edge                  Square tops with standard square corners                  Available on .5" thick top                  Available in 8 finishes</p>

## MOVE TABLE EDGES

<b>LMOV</b>	<b>Ply Move Edge</b>
	<p>.5" thick exposed Baltic Birch plywood edge                  Standard with .63" radius corners</p>
<b>WMOV</b>	<b>Veneer Move Edge</b>
	<p>.5" thick wood edge                  Standard with .63" radius corners                  Available in 5 wood species and 20 stains</p>
<b>C1MOV &amp; C2MOV</b>	<b>Corian® Move Edge</b>
	<p>.5" thick Corian® material                  Standard with .63" radius corners                  Available in 8 standard colors</p>

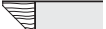
## TRIAD TABLE EDGES

<b>WWTR</b>	<b>Triad Prism Edge</b>
	<p>1" x 1" prism wood edge                  Available on 1" thick top                  Available in Ash and 6 stains</p>
<b>C1PR &amp; C2PR</b>	<b>Corian® Prism Edge</b>
	<p>.5" thick Corian® material with 1" edge                  Square and rectangle tops standard with square corners                  Available in 8 standard colors</p>

# PRODUCT SPECIFICATIONS – *Material and Finish Codes*

## BASE FINISHES

---

### Powder Coat

#### Solids

<b>MWM</b>	Matte White
<b>MWG</b>	Gloss White
<b>MLG</b>	Light Grey
<b>MMG</b>	Medium Grey
<b>MBM</b>	Matte Black
<b>MBG</b>	Gloss Black

#### Metallics

<b>MSL</b>	Silver
<b>MDB</b>	Dark Bronze

#### Textures

<b>MWT</b>	White Texture
<b>MRB</b>	Rubbed Bronze
<b>MBT</b>	Black Texture

### Plated

#### Standards

<b>MSC</b>	Satin Chrome
<b>MPC</b>	Polished Chrome

#### Premiums

<b>MSB</b>	Satin Brass
<b>MPB</b>	Polished Brass
<b>MAB</b>	Antique Brass
<b>MBB</b>	Blackened Brass
<b>MSO</b>	Satin Copper
<b>MPO</b>	Polished Copper
<b>MSZ</b>	Statuary Bronze

### Stainless Steel

<b>MSS</b>	Satin Stainless Steel
<b>MPS</b>	Polished Stainless Steel

### Custom

<b>CPC</b>	Custom Powder Coat
------------	--------------------

## SURFACE MATERIALS

---

### Laminate (Surface and Self Edge)

#### Solids

<b>LDV</b>	Dover White
<b>LDW</b>	Designer White
<b>LFG</b>	Fashion Grey
<b>LMS</b>	Mouse
<b>LJB</b>	Jett Black

#### Wood Looks

<b>LHL</b>	High Line
<b>LPE</b>	Park Elm
<b>LAL</b>	Appears Likeatre
<b>LLT</b>	Looks Likeatre
<b>LAE</b>	5th Ave. Elm
<b>LST</b>	Studio Teak
<b>LSB</b>	Sable

#### Patterns

<b>LCC</b>	Cool Chic
<b>LSS</b>	Serene Stardom
<b>LCD</b>	Calm Distinction
<b>LEE</b>	Easy Elegance

#### Metal Looks

<b>LPS</b>	Pearl Silver
<b>LSO</b>	Satin Oxide
<b>LSA</b>	Silver Alu Metalx

See WCI Laminate Reference Guide, page 30 for additional information

Natural variations in color, grain, texture and finish may occur depending on the WCI material specified.

# PRODUCT SPECIFICATIONS – Material and Finish Codes

## SURFACE MATERIALS

---

### Wood Veneer

#### Ash

<b>WCA</b>	Clear Ash
<b>WNA</b>	Natural Ash
<b>WTA</b>	Taupe Ash
<b>WAA</b>	Amber Ash
<b>WWA</b>	Walnut Ash
<b>WDA</b>	Dark Ash

#### Rift Cut Oak

<b>WNO</b>	Natural Rift Oak
<b>WMO</b>	Medium Rift Oak
<b>WDO</b>	Dark Rift Oak
<b>WEO</b>	Ebony Rift Oak

#### Maple

<b>WNM</b>	Natural Maple
<b>WGM</b>	Golden Maple
<b>WDM</b>	Dark Maple

#### Walnut

<b>WNW</b>	Natural Walnut
<b>WMW</b>	Medium Walnut
<b>WDW</b>	Dark Walnut

#### Cherry

<b>WNC</b>	Natural Cherry
<b>WMC</b>	Medium Cherry
<b>WDC</b>	Dark Cherry
<b>WMA</b>	Mahogany Over Cherry <b>Solid Wood</b>

#### Butcher Block

<b>BNM</b>	Natural Maple
<b>BNC</b>	Natural Cherry Over Maple
<b>BMA</b>	Mahogany Over Maple

See Solid Surface Reference Guide, page 35 for additional information

### Corian®

#### Solids

<b>CDW</b>	Designer White
<b>CGW</b>	Glacier White
<b>CSG</b>	Silver Gray
<b>CDS</b>	Deep Sable

#### Patterns

<b>CRC</b>	Rain Cloud
<b>CNS</b>	Deep Night Sky
<b>CLN</b>	Linen
<b>CDM</b>	Deep Mink

See Solid Surface Reference Guide, page 35 for additional information

### Quartz\*

#### Caesarstone®

<b>QOF</b>	Ocean Foam
<b>QPB</b>	Pebble
<b>QCT</b>	Concrete
<b>QRV</b>	Raven

#### Viatera by LX Hausys®

<b>QMN</b>	Minuet
------------	--------

#### Silestone®

<b>QWZ</b>	Blanco Zeus
------------	-------------

#### Wilsonart®

<b>QXR</b>	Xcaret
------------	--------

See Quartz Reference Guide, page 36 for additional information

\*Available on select tables only.

Natural variations in color, grain, texture and finish may occur depending on the WCI material specified.

# PRODUCT SPECIFICATIONS – Material and Finish Codes

## EDGE MATERIALS

---

### Laminate

#### Solids

LDV	Dover White
LDW	Designer White
LFG	Fashion Grey
LMS	Mouse
LJB	Jett Black

#### Wood Looks

LHL	High Line
LPE	Park Elm
LAL	Appears Likeatre
LLT	Looks Likeatre
LAE	5th Ave. Elm
LST	Studio Teak
LSB	Sable

#### Patterns

LCC	Cool Chic
LSS	Serene Stardom
LCD	Calm Distinction
LEE	Easy Elegance

#### Metal Looks

LPS	Pearl Silver
LSO	Satin Oxide
LSA	Silver Alu Metalx

### Vinyl & PVC

VFW	Frosty White
VSR	Surf
VPD	Pepperdust
VTN	Tan
VGY	Grey
VWH	Designer White
VFG	Fashion Grey
VFO	Fog
VNS	North Sea
VGP	Graphite
VSG	Slate Grey
VBK	Black

### Wood

#### Rift Cut Oak

WNO	Natural Rift Oak
WMO	Medium Rift Oak
WDO	Dark Rift Oak
WEO	Ebony Rift Oak

#### Maple

WNM	Natural Maple
WGM	Golden Maple
WDM	Dark Maple

#### Walnut

WNW	Natural Walnut
WMW	Medium Walnut
WDW	Dark Walnut

#### Cherry

WNC	Natural Cherry
WMC	Medium Cherry
WDC	Dark Cherry
WMA	Mahogany Over Cherry

Natural variations in color, grain, texture and finish may occur depending on the WCI material specified.

## PRODUCT SPECIFICATIONS – Laminate Reference Guide

WCI's standard laminate palette offers 19 solid, wood look, patterned, and metal look laminates all of which are available at standard pricing and lead times.

Materials	Manufacturer Code	Manufacturer Name	WCI Code
<b>Solids</b>			
Formica	7197-58	Dover White	LDV
Wilsonart	D354-60	Designer White	LDW
Wilsonart	D381-60	Fashion Grey	LFG
Formica	928-58	Mouse	LMS
Nevamar	S6053T	Jett Black	LJB
<b>Wood Looks</b>			
Wilsonart	7970K-18	High Line	LHL
Wilsonart	7967K-12	Park Elm	LPE
Pionite	WP115	Appears Likeatre	LAL
Pionite	WP110	Looks Likeatre	LLT
Wilsonart	7966K-12	5th Ave. Elm	LAE
Wilsonart	7960K-18	Studio Teak	LST
Pionite	AG021	Sable	LSB
<b>Patterns</b>			
Nevamar	VA7002T	Cool Chic	LCC
Nevamar	VA5001T	Serene Stardom	LSS
Nevamar	VA6001T	Calm Distinction	LCD
Nevamar	VA5002T	Easy Elegance	LEE
<b>Metal Looks</b>			
Wilsonart	D487-07	Pearl Silver	LPS
Wilsonart	4832K-07	Satin Oxide	LSO
Nevamar	MXT003T	Silver Alu Metalx	LSA

**Standard Laminates:** WCI offers 19 standard laminates including: Formica, Nevamar, Pionite, and Wilsonart. To see an expanded offering, please visit the laminate manufacturers' websites at:

formica.com  
 nevamar.com  
 pionite.com  
 wilsonart.com

Non-standard laminates from Formica, Nevamar, Pionite, and Wilsonart are also available. Non-standard WCI laminates will incur a minimum of 150 list set-up charge per laminate color. Please contact WCI Customer Service at 844-815-2217 for all special laminate requests.

**Premium Laminates:** Other laminates from these manufacturers or laminates from other manufacturers are available, such as Arborite®, Laminart®, and Abet Laminati®. These require a special pricing; please contact WCI's Customer Service Department at 844-815-2217 for all special laminate requests.

# PRODUCT SPECIFICATIONS – Laminate Reference Guide

	Standard Laminates				Vinyl/PVC Edges											
	Manufacturer	Manufacturer Code	WCI Code	Name	VFW Frosty White	VSR Surf	VPD Pepperdust	VTN Tan	VGX Grey	VWH DesignerWhite	VFG Fashion Grey	VFO Fog	VNS North Sea	VGP Graphite	VSG Slate Grey	VBK Black
Solids	Formica	7197-58	LDV	Dover White	P											
	Wilsonart	D354-60	LDW	Designer White						P						
	Wilsonart	D381-60	LFG	Fashion Grey							P					
	Formica	928-58	LMS	Mouse									P			
	Nevamar	S6053-T	LJB	Jett Black												P
Wood Looks	Wilsonart	7970K-18	LHL	High Line				P								
	Wilsonart	7967K-12	LPE	Park Elm				P								
	Pionite	WP115	LAL	Appears Likeatre				P								
	Pionite	WP110	LLT	Looks Likeatre			P		C							
	Wilsonart	7966K-12	LAE	5th Ave. Elm					P							
	Wilsonart	7960K-18	LST	Studio Teak												P
	Pionite	AG021	LSB	Sable										P		C
Patterns	Nevamar	VA7002T	LCC	Cool Chic		P										
	Nevamar	VA5001T	LSS	Serene Stardom									P			
	Nevamar	VA6001T	LCD	Calm Distinction									P			
	Nevamar	VA5002T	LEE	Easy Elegance										C	P	C
Metal Looks	Wilsonart	D487--07	LPS	Pearl Silver							P					
	Wilsonart	4832K-07	LSO	Satin Oxide			P					C				
	Nevamar	MXT003T	LSA	Silver Alu Metalx								P	C			

P : Primary Match (recommended)  
 C : Compatible Match (alternative)

## PRODUCT SPECIFICATIONS – *Solid Surface Reference Guide*

### Corian®

Corian® is a solid surface material created by DuPont, composed of acrylic polymer and alumina trihydrate. Corian® is available in a vast range of trendsetting patterns and tones.

WCI Corian® Standard Colors	WCI Code
<b>Group A</b>	
Designer White	CDW
Glacier White	CGW
Linen	CLN
<b>Group B</b>	
Silver Gray	CSG
Rain Cloud	CRC
Deep Night Sky	CNS
Linen	CLN
Deep Mink	CDM
Deep Sable	CDS

Corian® tops are not sold separately as a standard product. All top-only requests must be processed as a custom product. Steel sub-frames are designed to fit only WCI's standard bases. A minimum of five Corian® tops, per color, is required for non-standard Corian® top orders. To see an expanded offering, please visit Corian's website: [www.dupont.com](http://www.dupont.com)

# PRODUCT SPECIFICATIONS – Quartz Reference Guide

## Caesarstone® Quartz and Okite® Quartz

Engineered stone tops offer one of the most durable stone composite surfaces. They are one of the toughest yet most beautiful of all minerals and have the look and feel of stone offering a more non-porous, scratch-resistant, stain-resistant and heat-resistant properties.

### Q1

WCI Ceasarstone® Standard Colors	Manufacturer Code	WCI Code
Ocean Foam	6141	QQF
Pebble	4030	QPB
Concrete	2003	QCO
Raven	4120	QRV

WCI Viatera by LX Hausys® Standard Colors	Manufacturer Code	WCI Code
---	-------------------	----------

Minuet	N/A	QMN
--------	-----	-----

WCI Silestone® Standard Colors	Manufacturer Code	WCI Code
--------------------------------	-------------------	----------

White Zeus	N/A	QWZ
------------	-----	-----

### Q2

WCI Wilsonart® Standard Colors	Manufacturer Code	WCI Code
--------------------------------	-------------------	----------

Xcaret	Q4006	QXR
--------	-------	-----

Quartz tops are not sold separately as a standard product. The material is only available for the following tables:

- Basic Round
- Blok
- Brae
- Brae Double
- Canvas
- Cube
- Cylinder
- Disc
- Flat Round
- Kone
- Parsons
- Platform
- Platform Double
- Regency
- Tulip
- Vista

Our standard quartz top offering features Okite® and Caesarstone® and is composed of up to 93% natural quartz and polymer resin.

To see an expanded offering, please visit the manufacturers' websites.

Caesarstone®: [caesarstoneus.com/products](http://caesarstoneus.com/products)

LX Hausys®: [lxhausys.com/us/products](http://lxhausys.com/us/products)

Silestone®: [cosentino.com/silestone](http://cosentino.com/silestone)

Wilsonart®: [wilsonart.com/quartz](http://wilsonart.com/quartz)

# PRODUCT SPECIFICATIONS – Wood Grains, Patterns, and Stain-to-Match

WCI wood veneer is book matched as standard.

For custom veneer patterns contact customer service at **844-815-2217** for quotation.

Long grain is standard on all WCI tables.

Single piece tables are available in lengths longer than 10' and are subject to material length availability.

Note: Material length restrictions may require WCI to manufacture the tables in two or more sections.

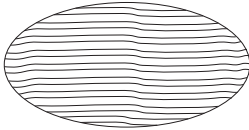

Long grain is standard on all WCI oval table tops

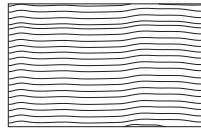

Long grain is standard on all WCI rectangle tables.

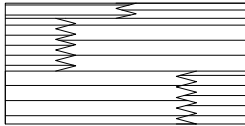

Finger jointed strips are standard on all WCI butcher block table requests.

## WCI Standard Veneer Specification

Oak: White Oak, Rift cut, Slip match

Walnut: Walnut, Plain sliced, Book match

Cherry: Cherry, Plain sliced, Book match

Maple: Maple, Plain sliced, Book match

Ash: White ash, Quarter sawn, Slip match

## Stain-to-Match

Send all stain-to-match samples marked with WCI's quote number. If you do not have a quote number please mark with project name and send to:

West Coast Industries  
Attn: Order Entry  
361 N, Bernoulli Circle  
Oxnard, CA 93030

The stain-to-match process takes 10 days.

# PRODUCT SPECIFICATIONS – Grommet Locations

Specify the desired grommet location using the chart below.  
For custom locations please submit a sketch for location feasibility and verification.

## Grommet Locations For Radius Tops.

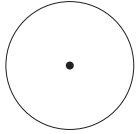

Location "A"

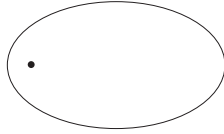

Location "B"

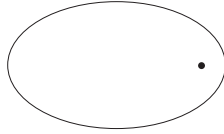

Location "C"

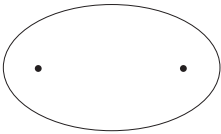

Location "D"

## Grommet Locations For Square Corner Tops.

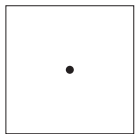

Location "A"



Location "B"



Location "C"



Location "D"

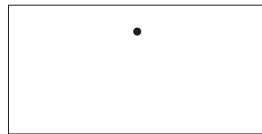

Location "E"

# PRODUCT SPECIFICATIONS – ADA Tables

## WHEELCHAIR ACCESS

To comply with ADA regulations for wheelchair access to tables WCI recommends a minimum clearance of 27" from the floor to the bottom of the table; a minimum 30" barrier free width and a minimum barrier free depth of 19". In addition there must be a minimum of 30" unobstructed space from the table edge. Overall table height cannot exceed 34".

For more information on ADA requirements, the following websites may be useful:  
National Network of ADA Centers: [www.adata.org](http://www.adata.org)  
U.S. Justice Department - ADA Home Page: [www.ada.gov](http://www.ada.gov)  
ABA and ABA Guidelines Home Page: [www.access-board.gov](http://www.access-board.gov)

### Minimum Clearance Recommendations

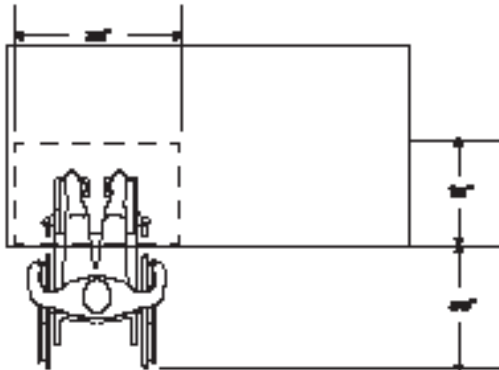

- \* Vista is the only ADA table that must be at least 30.5" high.
- \* Parsons, Post Leg, & Vista can also be made for ADA in size 36"x36"

### ADA Logo

The blue ADA symbol is 1.75" high x 5" wide and is inset from the front table edge on the right-hand side (from seated position).

Drawing is not to scale.

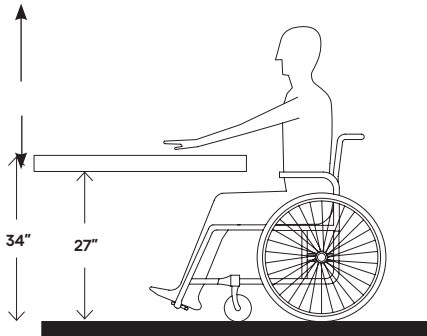

# PRODUCT SPECIFICATIONS – Seating



## INSIDE BACK STYLES

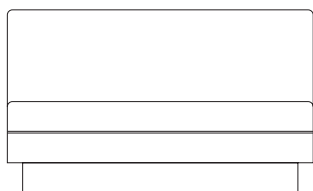

Plain upholstered (standard)

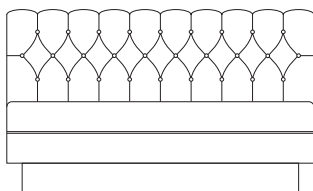

Diamond tufted

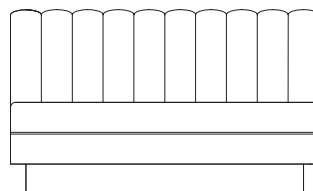

3" – 6" wide vertical channels

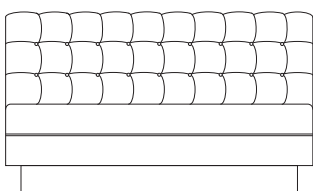

Biscuit tufted



6" wide horizontal channels

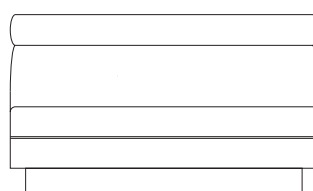

Plain back with 4" – 6" wide headroll

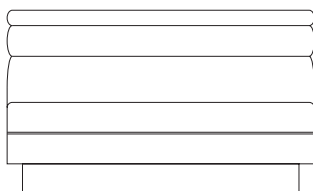

Graduating width horizontal channels

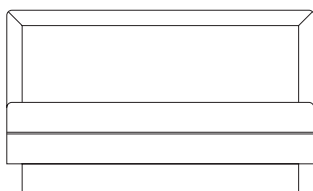

Plain back with 3" wide picture frame headroll

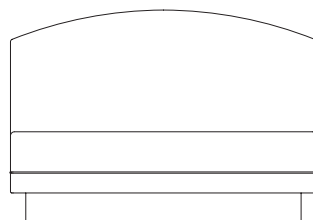

High rise curved back

## PRODUCT SPECIFICATIONS – Seating



### END PANEL STYLES

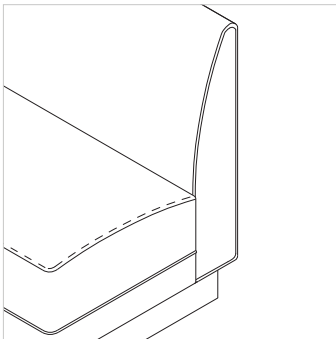

Wrap-around upholstered (standard)

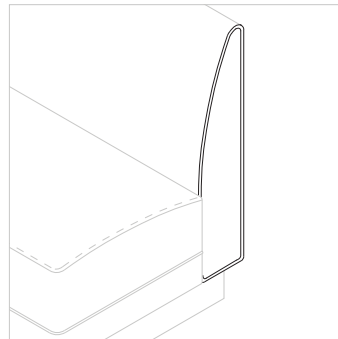

Self upholstered with welt all around

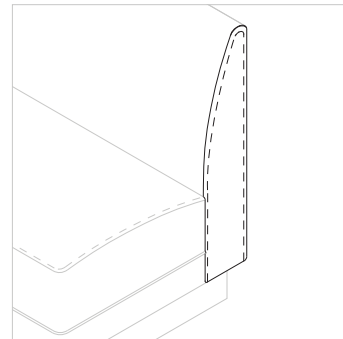

Self upholstered with french stitch

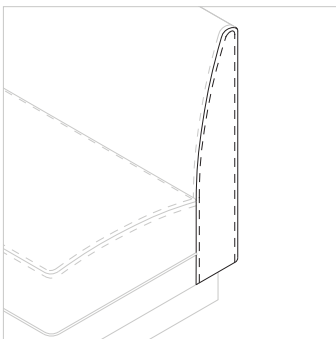

Self upholstered with baseball stitch

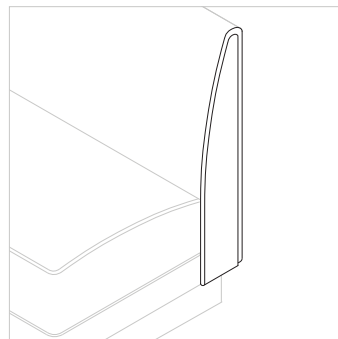

Applied upholstered end panel with welt all around

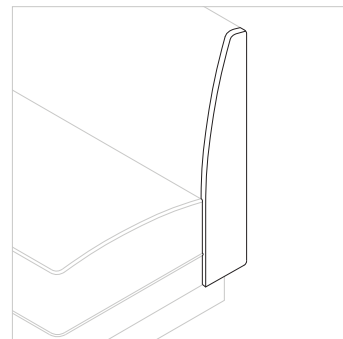

Applied laminate or wood veneer end panel

# PRODUCT SPECIFICATIONS – Seating



## SEAT STYLES

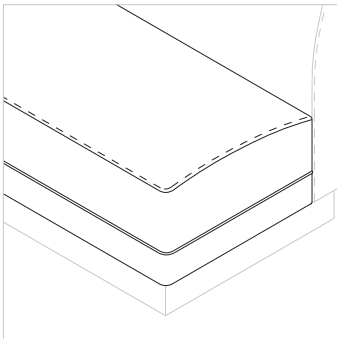

Plain upholstered with french stitch on all seat top edges (standard)

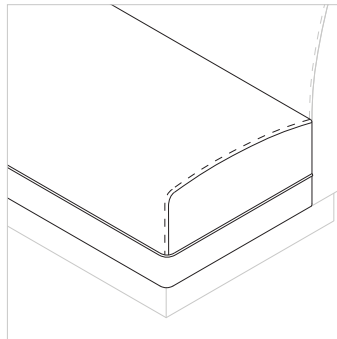

Waterfall upholstered front and back edges with french stitch on ends

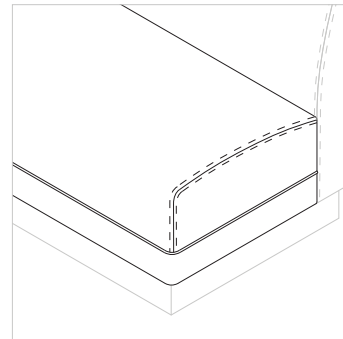

Waterfall upholstered front and back edges with baseball stitch on ends

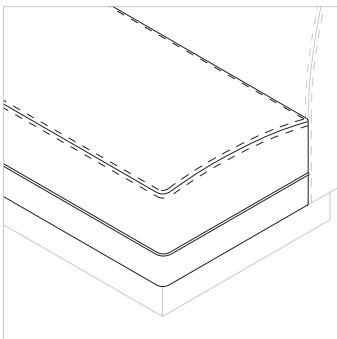

Plain upholstered with baseball stitch on all seat top edges

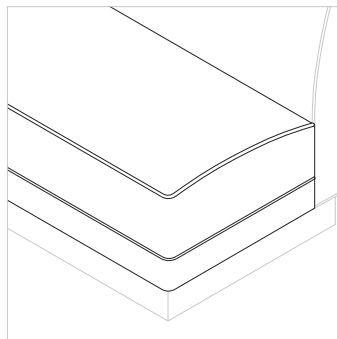

Plain upholstered with welt on all seat top edges

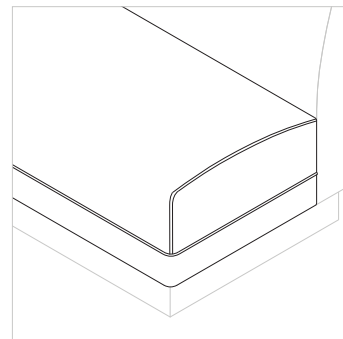

Waterfall upholstered front and back edges with welt on ends

# PRODUCT SPECIFICATIONS – Seating



## SEAT APRON STYLES

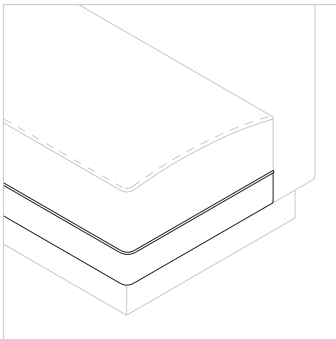

Flush seat upholstered apron with welt (standard)

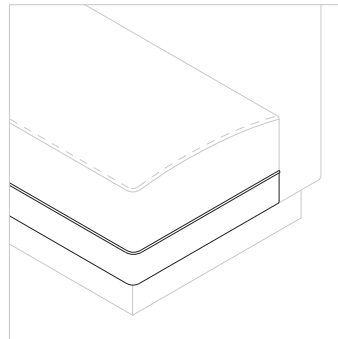

Flush seat laminate apron with welt

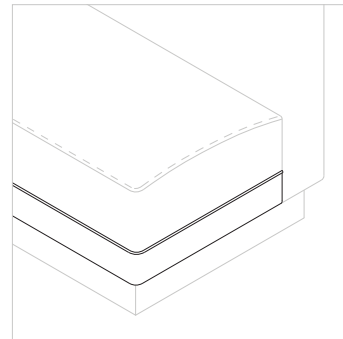

Flush seat wood veneer apron with welt

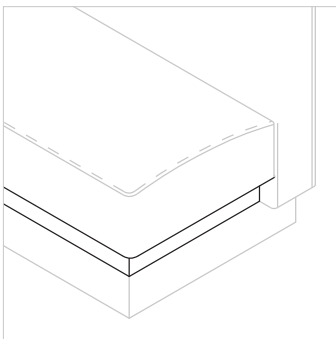

Recessed seat apron

## PRODUCT SPECIFICATIONS – Seating



### BASE AND LEG STYLES

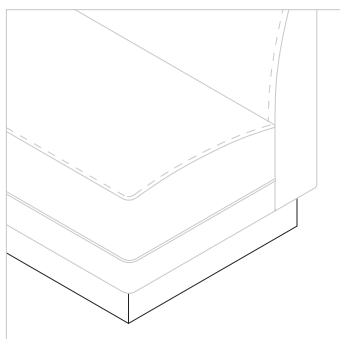

Enclosed base square corners, square or slanted profile (standard)

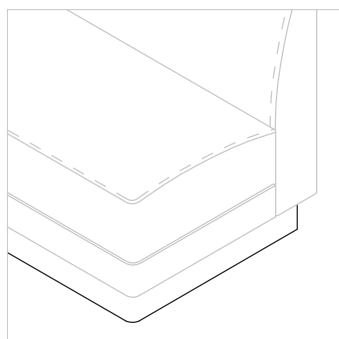

Enclosed base radius corners

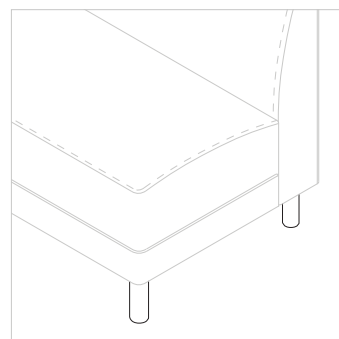

Metal or wooden round legs

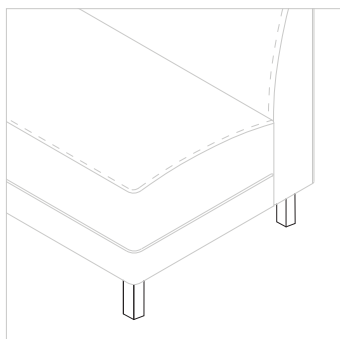

Metal or wooden square legs

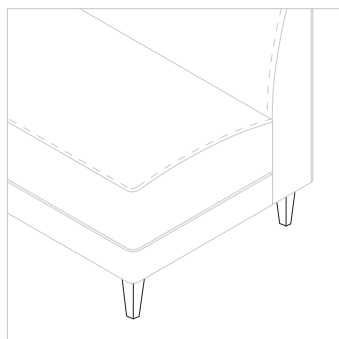

Metal or wooden tapered legs

A recessed base can be used in conjunction with leg supports for additional stability.

## PRODUCT SPECIFICATIONS – Seating

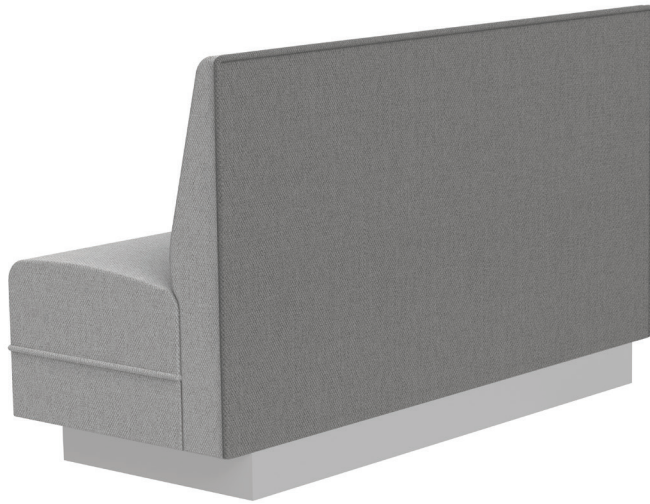

### OUTSIDE BACK STYLES

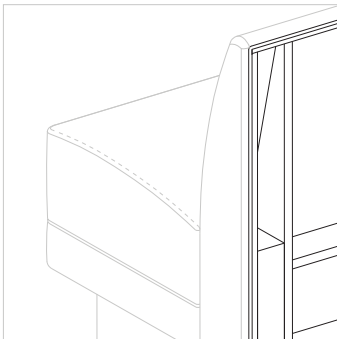

Unfinished (standard)

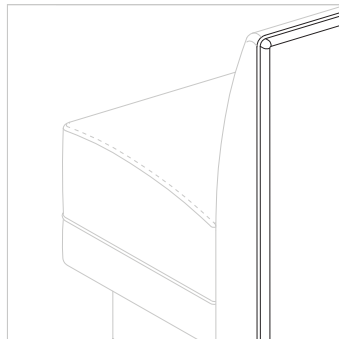

Plain upholstered with welt

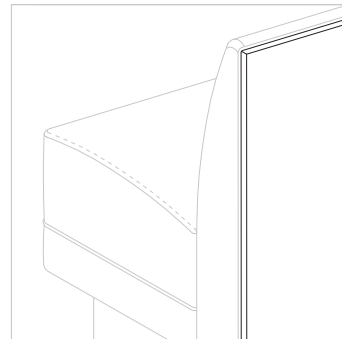

Applied laminate or wood veneer back with welt

Custom back materials are available upon request.

**PRODUCT SPECIFICATIONS – Seating**

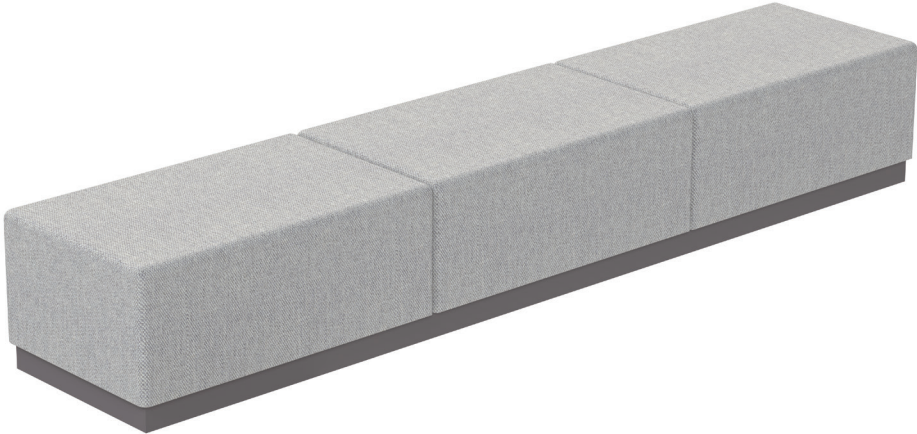

**BENCH BASE AND LEG STYLES**

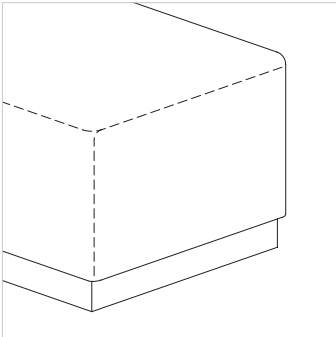

Enclosed base square corners, square or slanted profile (standard)

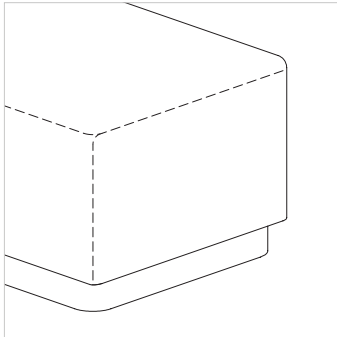

Enclosed base radius corners

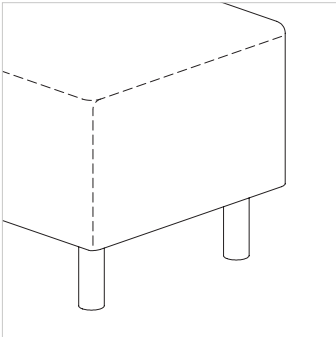

Metal or wooden round legs

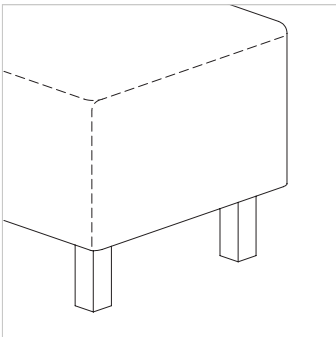

Metal or wooden square legs

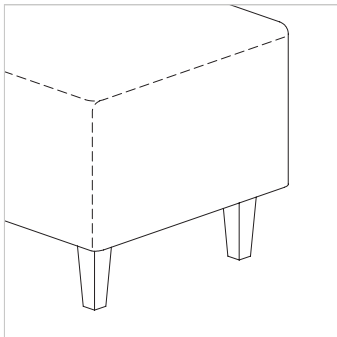

Tapered metal or wooden legs

Custom back materials are available upon request.

# PRODUCT SPECIFICATIONS – Seating



## OTTOMAN BASE AND LEG STYLES

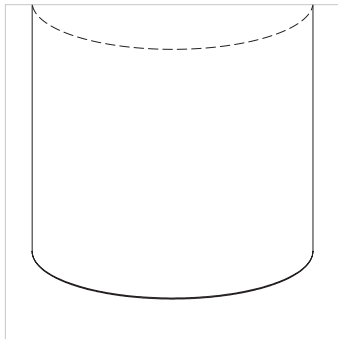

No base

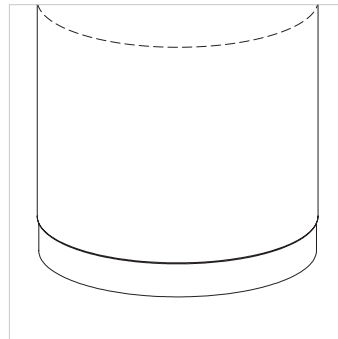

Enclosed base radius corners

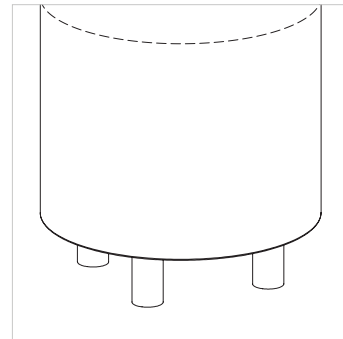

Metal or wooden round legs

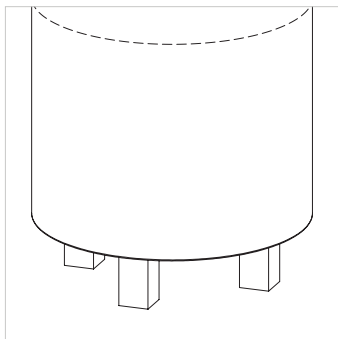

Metal or wooden square legs

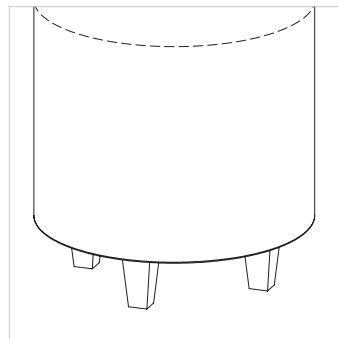

Tapered metal or wooden legs

# Pricing

## Dining and Multipurpose

50	Basic Round
54	Blok
56	Bolt Down
60	Brae
64	Brae Double
66	Canvas
64	Disc
76	Dunhill
82	Flat Round
86	Kone
90	Move
92	Parsons
96	Platform
100	Platform Double
102	Plus
108	Post Leg
112	Regency
116	Tulip
120	Vista

## Occasional

126	Blok
128	Brae
130	Cube
132	Cylinder
134	Disc
136	Kone
138	Move
140	Parsons
144	Platform
146	Triad

# Pricing

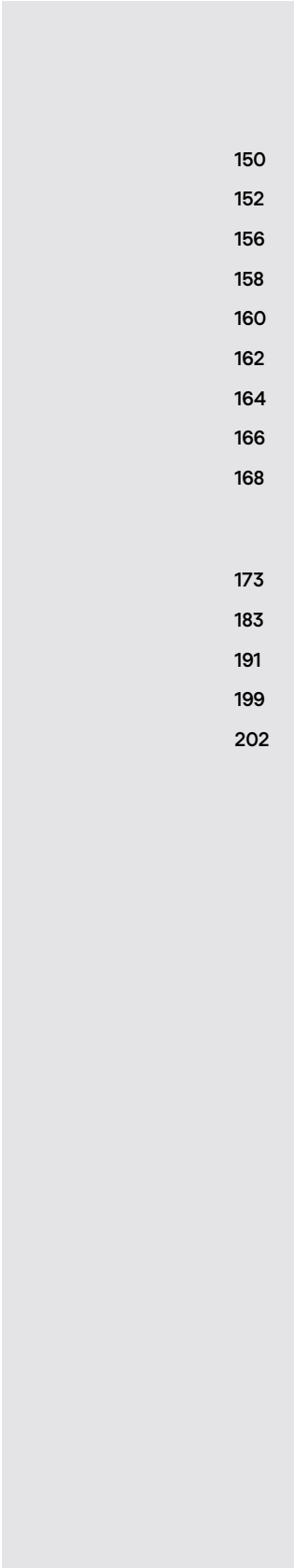

## Outdoor Tables

- 150 Basic Round
- 152 Brae
- 156 Brae Double
- 158 Disc
- 160 Flat Round
- 162 Platform
- 164 Platform Double
- 166 Tulip
- 168 Vista

- 173 Base and Top Matrix
- 183 Base Only Pricing
- 191 Top Only Pricing
- 199 Options Pricing
- 202 Power & Data

# BASIC ROUND – Dining

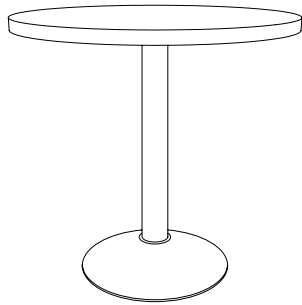

## Laminate Surface

## Wood Surface

Self Edge	Vinyl Edges	PVC Edges	Wood Edges Group A	Wood Edges Group B	Wood Edges Group A	Wood Edges Group B	Butcher Block
LLSE Self Edge	LVFL Flat	LPVC PVC	LWFL Flat	LWSQ Square	WWFL Flat	WWSQ Square	BBFL Flat
	LVBP Bumper		LWTP Tapered Ply	LWBN Bullnose	WWTP Tapered Ply	WWBN Bullnose	BBBN Bullnose
			LWFP Flat Ply	LWPR Prism	WWFP Flat Ply	WWPR Prism	

## Complete Table List Pricing

	Top Size	Base Qty.	Base Style	Model #								
Round 	24	1	17L	BA24RD	613	613	702	980	1,274	996	1,401	1,254
	30	1	17M	BA30RD	782	782	889	1,239	1,555	1,360	1,707	1,746
	36	1	20M	BA36RD	978	978	1,105	1,517	1,883	1,561	2,067	2,340
	42	1	22L	BA42RD	1,145	1,145	1,287	1,709	2,161	1,873	2,381	3,250
	48	1	22M	BA48RD	1,395	1,395	1,555	2,022	2,541	2,217	2,801	3,802
	54	1	22H	BA54RD	1,659	1,659	1,843	2,468	3,540	2,710	3,914	-
	60	1	28H	BA60RD	2,220	2,220	2,419	2,931	3,936	3,561	4,332	-
RD Square 	24 24	1	17L	BA2424RS	616	616	713	979	1,275	996	1,401	1,376
	30 30	1	17M	BA3030RS	782	782	900	1,238	1,555	1,360	1,707	1,908
	36 36	1	20M	BA3636RS	979	979	1,097	1,498	1,883	1,562	2,067	2,547
	42 42	1	22M	BA4242RS	1,193	1,193	1,327	1,779	2,231	1,942	2,450	3,643
	48 48	1	22H	BA4848RS	1,467	1,467	1,623	2,090	2,609	2,284	2,869	4,248
Square 	24 24	1	17L	BA2424SQ	616	616	713	979	1,275	996	1,401	1,376
	30 30	1	17M	BA3030SQ	782	782	900	1,238	1,555	1,360	1,707	1,908
	36 36	1	20M	BA3636SQ	979	979	1,097	1,498	1,883	1,562	2,067	2,547
	42 42	1	22M	BA4242SQ	1,193	1,193	1,327	1,779	2,231	1,942	2,450	3,643
	48 48	1	22H	BA4848SQ	1,467	1,467	1,623	2,090	2,609	2,284	2,869	4,248

Continued on next page

## How to Order

### Table Model Number

<b>BA</b> Base Series	<b>36</b> Top Size	<b>RD</b> Top Shape	<b>WWSQ</b> Top Material Edge Profile	<b>MMW</b> Top Finish	<b>N/A</b> Edge Finish	<b>MBM</b> Base Finish
--------------------------	-----------------------	------------------------	---	--------------------------	---------------------------	---------------------------











A BA36RDWWSQMMWMBM is a Basic Round series 36" round table with a black powder coated, round base and a wood veneer 1.25" thick top with a 1.25" square wood edge profile.

### Options

<b>GSL</b> Super Level Glides
-------------------------------------

The code: GSL specifies super level glides.

Edge finish applies when edge material is different from top material.

Solid Surface		Quartz Surface	
Corian® Group A	Corian® Group B	Quartz Group A	Quartz Group B
 C1FL Flat	 C2FL Flat	 Q1FL Flat	 Q2FL Flat
 C1BN Bullnose	 C2BN Bullnose	 Q1BN Bullnose	 Q2BN Bullnose
 C1PR Prism	 C2PR Prism		

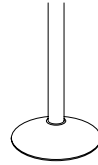

### Options

#### Base Finishes

Standard Black Texture	MBT	n/c
Powder Coat (per base)	use finish code	133
Custom Powder Coat (set-up charge)	CPC	📞
Polished or Satin Chrome (per base)	use finish code	289
Premium Plated (per base)	use finish code	578

#### Base Options

Counter, Bar, & Alternate Height (per column)	CH, BH, AH	80
Super Level Glides (per base)	GSL	42
Custom Top Plate Size	CTPS	📞
6" Column (black texture and powder coat)	COL6	235
6" Column (polished or satin chrome)	COLP6	300
6" Column (premium plated)	COLPP6	📞
6" Column (veneer)	COLV6	468
Base sizes may vary with quartz tops		

#### Top Materials and Finishes

Any non-standard WCI Laminates (set-up charge)	use manufacturers finish code	173
Premium Laminates	PL	📞
Custom Wood Veneer	CWV	📞
Stain to Match (set-up charge)	STM	500

#### Top Options

3" Radius Corner (per corner)	CRL3	42
(Laminate self edge & Corian®)		
3" Wood Radius Corner (per corner)	CRW3	100
(not available in LWFL and WWFL)		
Custom Size	CS	📞
Custom Radius Corner	CRC	100
Custom Shape	CSH	📞
Custom Edge Thickness	CET	📞

1,672	1,742	3,321	4,368
2,260	2,354	4,343	6,289
2,986	3,110	6,029	7,584
3,724	3,879	7,382	9,655
4,646	4,840	-	-
5,647	5,882	-	-
6,975	7,266	-	-
-	-	-	-
-	-	-	-
-	-	-	-
-	-	-	-
-	-	-	-
1,511	1,574	2,131	3,737
2,058	2,144	3,566	5,451
2,761	2,877	4,596	6,831
3,530	3,677	6,311	8,544
4,427	4,612	-	-

📞 Call for pricing

415.621.6656

# BASIC ROUND – Dining

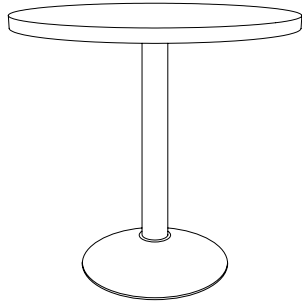

## Laminate Surface

## Wood Surface

Self Edge	Vinyl Edges	PVC Edges	Wood Edges Group A	Wood Edges Group B	Wood Edges Group A	Wood Edges Group B	Butcher Block
LLSE Self Edge	LVFL Flat	LPVC PVC	LWFL Flat	LWSQ Square	WWFL Flat	WWSQ Square	BBFL Flat
	LVBP Bumper		LWTP Tapered Ply	LWBN Bullnose	WWTP Tapered Ply	WWBN Bullnose	BBBN Bullnose
			LWFP Flat Ply	LWPR Prism	WWFP Flat Ply	WWPR Prism	

## Complete Table List Pricing

	Top Size	Base Qty.	Base Style	Model #									
Rectangle 	24	30	1	17M	BA2430RE	727	727	809	1,148	1,474	1,287	1,614	1,642
	24	36	1	20M	BA2436RE	834	834	926	1,314	1,630	1,429	1,786	1,934
	24	42	1	22L	BA2442RE	882	882	961	1,376	1,727	1,499	1,891	2,263
	24	48	1	22M	BA2448RE	1,014	1,014	1,112	1,572	1,961	1,712	2,145	2,428
	24	60	2	17L	BA2460RE	1,227	1,227	1,333	1,826	2,268	1,980	2,478	2,973
	24	72	2	17L	BA2472RE	1,329	1,329	1,451	1,995	2,502	2,174	2,745	3,411
	30	36	1	20M	BA3036RE	914	914	991	1,407	1,753	1,533	1,921	2,234
	30	42	1	22L	BA3042RE	966	966	1,056	1,563	1,953	1,707	2,145	2,652
	30	48	1	22M	BA3048RE	1,100	1,100	1,198	1,712	2,134	1,871	2,343	2,827
	30	60	2	17M	BA3060RE	1,468	1,468	1,580	2,134	2,618	2,316	2,857	3,577
	30	72	2	17M	BA3072RE	1,588	1,588	1,723	2,268	2,816	2,467	3,078	4,109
	36	42	1	22M	BA3642RE	1,118	1,118	1,221	1,730	2,159	1,892	2,368	3,096
	36	48	1	22M	BA3648RE	1,189	1,189	1,297	1,825	2,282	1,994	2,505	3,211
	36	60	2	20M	BA3660RE	1,699	1,699	1,825	2,350	2,869	2,545	3,128	4,160
	36	72	2	20M	BA3672RE	1,843	1,843	1,978	2,575	3,161	2,794	3,457	4,776

## How to Order

### Table Model Number

<b>BA</b> Base Series	<b>36</b> Top Size	<b>RD</b> Top Shape	<b>WWSQ</b> Top Material Edge Profile	<b>WMW</b> Top Finish	<b>N/A</b> Edge Finish	<b>MBM</b> Base Finish
--------------------------	-----------------------	------------------------	---	--------------------------	---------------------------	---------------------------











### Options

<b>GSL</b> Super Level Glides
-------------------------------------

A BA36RDWWSQWMWMBM is a Basic Round series 36" round table with a black powder coated, round base and a wood veneer 1.25" thick top with a 1.25" square wood edge profile.

Edge finish applies when edge material is different from top material.

The code: GSL specifies super level glides.

Solid Surface		Quartz Surface	
Corian® Group A	Corian® Group B	Quartz Group A	Quartz Group B
 C1FL Flat	 C2FL Flat	 Q1FL Flat	 Q2FL Flat
 C1BN Bullnose	 C2BN Bullnose	 Q1BN Bullnose	 Q2BN Bullnose
 C1PR Prism	 C2PR Prism		

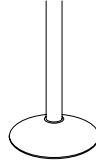

**Options**

**Base Finishes**

Standard Black Texture	MBT	n/c
Powder Coat (per base)	use finish code	133
Custom Powder Coat (set-up charge)	CPC	📞
Polished or Satin Chrome (per base)	use finish code	289
Premium Plated (per base)	use finish code	578

**Base Options**

Counter, Bar, & Alternate Height (per column)	CH, BH, AH	80
Super Level Glides (per base)	GSL	42
Custom Top Plate Size	CTPS	📞
6" Column (black texture and powder coat)	COL6	235
6" Column (polished or satin chrome)	COLP6	300
6" Column (premium plated)	COLPP6	📞
6" Column (veneer)	COLV6	468
Base sizes may vary with quartz tops		

**Top Materials and Finishes**

Any non-standard WCI Laminates (set-up charge)	use manufacturers finish code	173
Premium Laminates	PL	📞
Custom Wood Veneer	CWV	📞
Stain to Match (set-up charge)	STM	500

**Top Options**

3" Radius Corner (per corner)	CRL3	42
(Laminate self edge & Corian®)		
3" Wood Radius Corner (per corner)	CRW3	100
(not available in LWFL and WWFL)		
Custom Size	CS	📞
Custom Radius Corner	CRC	100
Custom Shape	CSH	📞
Custom Edge Thickness	CET	📞









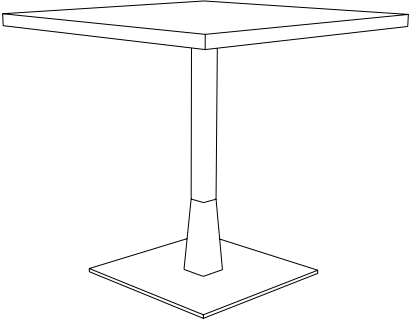







1,799	1,874	2,167	4,288
2,078	2,164	2,484	4,836
2,280	2,375	2,846	5,159
2,571	2,679	-	-
3,156	3,288	-	-
3,612	3,762	-	-
2,389	2,489	3,158	5,666
2,641	2,751	3,395	5,825
3,008	3,134	-	-
3,803	3,961	-	-
4,351	4,532	-	-
3,444	3,587	4,149	6,982
4,070	4,239	-	-
4,485	4,672	-	-
5,111	5,324	-	-

📞 Call for pricing



415.621.6656

# BLOK – Dining & Multipurpose













Laminate Surface			Wood Surface		
Self Edge	PVC Edges	Wood Edges Group A	Wood Edges Group A	Wood Edges Group B	Butcher Block
 LLSE Self Edge	 LPVC PVC	 LWFL Flat	 WWFL Flat	 WWSQ Square	 BBFL Flat
 LFSE Facet Self Edge		 LWTP Tapered Ply	 WWTP Tapered Ply	 WWBN Bullnose	 BBBN Bullnose
		 LWFP Flat Ply	 WWFP Flat Ply	 WWPR Prism	
			 WWFC Facet	 WWFC Facet	

## Complete Table List Pricing

	Top Size	Base Qty.	Model #						
	24	1	BL24RD	1,740	1,826	2,097	2,115	2,510	2,366
	30	1	BL30RD	1,845	1,948	2,290	2,409	2,750	2,788
	36	1	BL36RD	2,217	2,340	2,743	2,787	3,281	3,550
	48	1	BL48RD	3,142	3,298	3,755	3,947	4,518	5,497
	24 24	1	BL2424SQ	1,742	1,837	2,097	2,115	2,510	2,486
	30 30	1	BL3030SQ	1,845	1,960	2,290	2,409	2,750	2,946
	36 36	1	BL3636SQ	2,217	2,332	2,724	2,787	3,281	3,751
	42 42	1	BL4242SQ	2,944	3,075	3,516	3,678	4,175	5,341
	48 48	1	BL4848SQ	3,145	3,298	3,755	3,947	4,518	5,868
	24 30	1	BL2430RE	1,790	1,872	2,203	2,339	2,659	2,686
	24 42	1	BL2442RE	1,896	1,974	2,380	2,501	2,884	3,248
	24 48	2	BL2448RE	3,374	3,470	3,920	4,057	4,482	4,759
	24 60	2	BL2460RE	3,480	3,583	4,064	4,215	4,704	5,188
	30 36	1	BL3036RE	2,153	2,229	2,636	2,760	3,139	3,444
	30 42	1	BL3042RE	2,214	2,302	2,799	2,939	3,369	3,865
	30 48	1	BL3048RE	2,852	2,949	3,451	3,607	4,069	4,542
	30 60	2	BL3060RE	3,595	3,705	4,248	4,425	4,954	5,660
	30 72	2	BL3072RE	3,713	3,844	4,378	4,574	5,170	6,181
	36 42	1	BL3642RE	2,294	2,395	2,894	3,052	3,519	4,229
	36 48	1	BL3648RE	2,941	3,046	3,562	3,728	4,228	4,918
	36 60	2	BL3660RE	3,709	3,834	4,347	4,538	5,108	6,118
	36 72	2	BL3672RE	3,850	3,983	4,568	4,782	5,430	6,721

## How to Order

Table Model Number							Options	
<b>BL</b> Base Series	<b>36 36</b> Top Size	<b>SQ</b> Top Shape	<b>WWFC</b> Top Material Edge Profile	<b>WMW</b> Top Finish	<b>N/A</b> Edge Finish	<b>MBM</b> Base Finish	<b>WMW</b> Wood Column Finish	<b>AH</b> Alternate Height Base
<p>A BL3636SQWWFCWMWMBMWMW is a Blok series 36" x 36" square table with a black powder coat square base and a wood veneer 1.25" thick top with a 1.25" wood edge profile.</p>					<p>Edge finish applies when edge material is different from top material.</p>			<p>The code: AH specifies alternate height base.</p>

Solid Surface		Quartz Surface	
Corian® Group A	Corian® Group B	Quartz Group A	Quartz Group B
 C1FL Flat	 C2FL Flat	 Q1FL Flat	 Q2FL Flat
 C1BN Bullnose	 C2BN Bullnose	 Q1BN Bullnose	 Q2BN Bullnose
 C1PR Prism	 C2PR Prism		

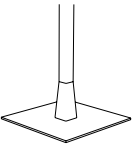

**Options**

Base Finishes		
Custom Powder Coat (set-up charge)	CPC	693
Polished or Satin Chrome (per base)	use finish code	1,502
Premium Plated (per base)	use finish code	1,733
Stainless Steel (per base)	use finish code	

Base Options		
Alternate Height Base (per column)(29.25 or lower)	AH	80
Nylon Octagon Glides (per base)	GNO	42
Custom Top Plate Size	CTPS	
Base sizes may vary with quartz tops		

Top Materials and Finishes		
Any non-standard WCI Laminates (set-up charge)	use manufacturers finish code	173
Premium Laminates	PL	
Custom Wood Veneer	CWV	
Stain to Match (set-up charge)	STM	500

Top Options		
3" Radius Corner (per corner) (Laminate self edge & Corian®)	CRL3	42
3" Wood Radius Corner (per corner) (not available in LWFL and WWFL)	CRW3	99
Custom Radius Corner	CRC	99
Custom Size	CS	
Custom Shape	CSH	
Custom Edge Thickness	CET	

2,933	3,055	4,365	5,346
3,453	3,597	5,328	7,209
4,374	4,557	7,175	8,657
6,607	6,882	-	-
2,772	2,888	3,180	4,717
3,250	3,385	4,555	6,374
4,151	4,324	5,748	7,905
5,494	5,723	7,935	10,063
6,312	6,575	-	-
2,994	3,119	3,160	5,213
3,420	3,563	3,794	6,043
5,210	5,427	-	-
5,677	5,914	-	-
3,779	3,937	4,314	6,745
4,042	4,210	4,558	6,911
4,972	5,180	-	-
6,191	6,449	-	-
6,735	7,015	-	-
4,767	4,965	5,247	8,004
6,030	6,281	-	-
6,747	7,028	-	-
7,368	7,675	-	-

Call for pricing



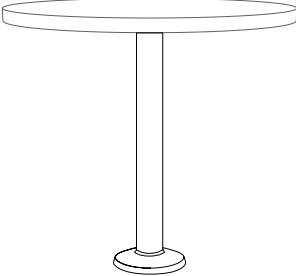

415.621.6656

# BOLT DOWN – Dining



Laminate Surface					Wood Surface				
Self Edge	Vinyl Edges	PVC Edges	Wood Edges Group A	Wood Edges Group B	Wood Edges Group A	Wood Edges Group B	Butcher Block		
LLSE Self Edge	LVFL Flat	LPVC PVC	LWFL Flat	LWSQ Square	WWFL Flat	WWSQ Square	BBFL Flat		
	LVBP Bumper		LWTP Tapered Ply	LWBN Bullnose	WWTP Tapered Ply	WWBN Bullnose	BBBN Bullnose		
			LWFP Flat Ply	LWPR Prism	WWFP Flat Ply	WWPR Prism			

## Complete Table List Pricing







	Top Size	Base Qty.	Model #								
Round 	24	1	JB24RD	761	761	849	1,128	1,422	1,143	1,549	1,401
	30	1	JB30RD	869	869	975	1,325	1,641	1,446	1,793	1,833
	36	1	JB36RD	1,008	1,008	1,134	1,546	1,912	1,590	2,096	2,369
	42	1	JB42RD	1,185	1,185	1,326	1,747	2,200	1,912	2,420	3,290
	48	1	JB48RD	1,365	1,365	1,523	1,992	2,511	2,186	2,771	3,772
RD Square 	24 24	1	JB2424RS	764	764	860	1,127	1,423	1,143	1,549	1,523
	30 30	1	JB3030RS	868	868	986	1,325	1,641	1,446	1,793	1,994
	36 36	1	JB3636RS	1,008	1,008	1,127	1,527	1,912	1,591	2,096	2,576
	42 42	1	JB4242RS	1,163	1,163	1,296	1,748	2,200	1,912	2,420	3,612
	48 48	1	JB4848RS	1,369	1,369	1,523	1,992	2,511	2,186	2,771	4,150
Square 	24 24	1	JB2424SQ	764	764	860	1,127	1,423	1,143	1,549	1,523
	30 30	1	JB3030SQ	868	868	986	1,325	1,641	1,446	1,793	1,994
	36 36	1	JB3636SQ	1,008	1,008	1,127	1,527	1,912	1,591	2,096	2,576
	42 42	1	JB4242SQ	1,163	1,163	1,296	1,748	2,200	1,912	2,420	3,612
	48 48	1	JB4848SQ	1,369	1,369	1,523	1,992	2,511	2,186	2,771	4,150
Rectangle 	24 30	1	JB2430RE	813	813	895	1,234	1,560	1,375	1,700	1,728
	24 36	1	JB2436RE	863	863	955	1,343	1,659	1,458	1,815	1,964
	24 42	1	JB2442RE	921	921	1,001	1,414	1,765	1,538	1,931	2,301
	24 48	1	JB2448RE	983	983	1,082	1,542	1,931	1,681	2,115	2,398
	24 60	2	JB2460RE	1,522	1,522	1,627	2,120	2,563	2,275	2,773	3,267
	24 72	2	JB2472RE	1,624	1,624	1,746	2,291	2,796	2,470	3,040	3,705

Continued on next page

## How to Order

Table Model Number						Options	
<b>JB</b> Base Series	<b>36</b> Top Size	<b>RD</b> Top Shape	<b>WWSQ</b> Top Material Edge Profile	<b>WMW</b> Top Finish	<b>N/A</b> Edge Finish	<b>MBM</b> Base Finish	<b>AH</b> Alternate Height Base
<p>A JB36RDWWSQWMWMBM is a Bolt Down series 36" round table with a black powder coat bolt down base and a wood veneer 1.25" thick top with a 1.25" square wood edge profile.</p>						<p>Edge finish applies when edge material is different from top material.</p>	<p>The code: AH specifies alternate height base.</p>

Solid Surface

Corian® Group A	Corian® Group B
 <b>C1FL</b> Flat	 <b>C2FL</b> Flat
 <b>C1BN</b> Bullnose	 <b>C2BN</b> Bullnose
 <b>C1PR</b> Prism	 <b>C2PR</b> Prism

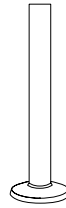

1,833	1,910
2,355	2,453
3,018	3,143
3,766	3,923
4,613	4,806
-	-
-	-
-	-
-	-
-	-
1,672	1,742
2,152	2,241
2,793	2,910
3,497	3,642
4,320	4,500
1,894	1,973
2,109	2,197
2,322	2,419
2,538	2,644
3,478	3,623
3,934	4,098

Options

Base Finishes

Custom Powder Coat (set-up charge)	CPC	92
Polished or Satin Chrome (per base)	use finish code	145
Premium Plated (per base)	use finish code	1,733
Stainless Steel (per base)	use finish code	

Base Options

Counter, Bar, & Alternate Height (per column)	CH, BH, AH	80
Custom Top Plate Size	CTPS	

Top Materials and Finishes

Any non-standard WCI Laminates (set-up charge)	use manufacturers finish code	173
Premium Laminates	PL	
Custom Wood Veneer	CWV	
Stain to Match (set-up charge)	STM	500

Top Options









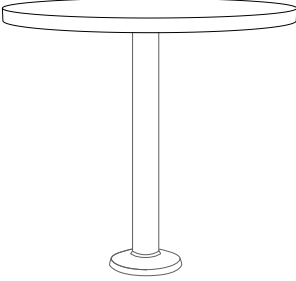









3" Radius Corner (per corner) (Laminate self edge & Corian®)	CRL3	42
3" Wood Radius Corner (per corner) (not available in LWFL and WWFL)	CRW3	100
Custom Radius Corner	CRC	100
Custom Size	CS	
Custom Shape	CSH	
Custom Edge Thickness	CET	

Call for pricing

415.621.6656

# BOLT DOWN – Dining



Laminate Surface				Wood Surface			
Self Edge	Vinyl Edges	PVC Edges	Wood Edges Group A	Wood Edges Group B	Wood Edges Group A	Wood Edges Group B	Butcher Block
 LSE Self Edge	 LVFL Flat	 LPVC PVC	 LWFL Flat	 LWSQ Square	 WWFL Flat	 WWSQ Square	 BBFL Flat
	 LVBP Bumper		 LWTP Tapered Ply	 LWBN Bullnose	 WWTP Tapered Ply	 WWBN Bullnose	 BBBN Bullnose
			 LWFP Flat Ply	 LWPR Prism	 WWFP Flat Ply	 WWPR Prism	







## Complete Table List Pricing

	Top Size		Base Qty.	Model #								
Rectangle  	30	36	1	JB3036RE	943	943	1,020	1,436	1,782	1,563	1,951	2,263
	30	42	1	JB3042RE	1,004	1,004	1,095	1,602	1,992	1,747	2,185	2,691
	30	48	1	JB3048RE	1,068	1,068	1,166	1,681	2,104	1,840	2,312	2,795
	30	60	2	JB3060RE	1,641	1,641	1,752	2,307	2,790	2,488	3,029	3,749
	30	72	2	JB3072RE	1,761	1,761	1,896	2,439	2,989	2,639	3,250	4,282
	36	42	1	JB3642RE	1,088	1,088	1,191	1,700	2,128	1,862	2,338	3,065
	36	48	1	JB3648RE	1,159	1,159	1,267	1,793	2,252	1,964	2,474	3,181
	36	60	2	JB3660RE	1,757	1,757	1,884	2,409	2,928	2,604	3,186	4,218
	36	72	2	JB3672RE	1,901	1,901	2,036	2,633	3,219	2,853	3,515	4,834

## How to Order

Table Model Number						Options	
<b>JB</b> Base Series	<b>36</b> Top Size	<b>RD</b> Top Shape	<b>WWSQ</b> Top Material Edge Profile	<b>MMW</b> Top Finish	<b>N/A</b> Edge Finish	<b>MBM</b> Base Finish	<b>AH</b> Alternate Height Base
A JB36RDWWSQMMWMBM is a Bolt Down series 36" round table with a black powder coat bolt down base and a wood veneer 1.25" thick top with a 1.25" square wood edge profile.						Edge finish applies when edge material is different from top material.	The code: AH specifies alternate height base.

Solid Surface

Corian® Group A	Corian® Group B
 C1FL Flat	 C2FL Flat
 C1BN Bullnose	 C2BN Bullnose
 C1PR Prism	 C2PR Prism

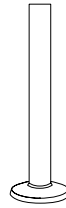

2,421	2,522
2,684	2,795
2,975	3,099
3,992	4,158
4,538	4,727
3,410	3,552
4,035	4,203
4,549	4,738
5,174	5,390

Options

Base Finishes

Custom Powder Coat (set-up charge)	CPC	92
Polished or Satin Chrome (per base)	use finish code	145
Premium Plated (per base)	use finish code	1,733
Stainless Steel (per base)	use finish code	

Base Options

Counter, Bar, & Alternate Height (per column)	CH, BH, AH	80
Custom Top Plate Size	CTPS	

Top Materials and Finishes

Any non-standard WCI Laminates (set-up charge)	use manufacturers finish code	173
Premium Laminates	PL	
Custom Wood Veneer	CWV	
Stain to Match (set-up charge)	STM	500











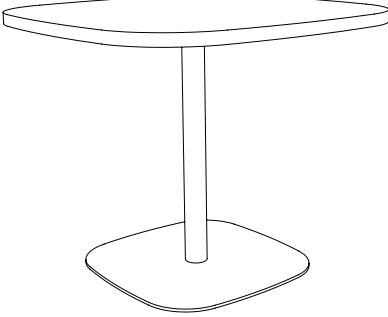







Top Options

3" Radius Corner (per corner) (Laminate self edge & Corian®)	CRL3	42
3" Wood Radius Corner (per corner) (not available in LWFL and WWFL)	CRW3	100
Custom Radius Corner	CRC	100
Custom Size	CS	
Custom Shape	CSH	
Custom Edge Thickness	CET	





Call for pricing

415.621.6656

# BRAE – Dining & Multipurpose

	Laminate Surface				Wood Surface			
	Self Edge	Vinyl Edges	PVC Edges	Wood Edges Group A	Wood Edges Group B	Wood Edges Group A	Wood Edges Group B	Butcher Block
	 LLSE Self Edge	 LVFL Flat	 LPVC PVC	 LWFL Flat	 LWSQ Square	 WWFL Flat	 WWSQ Square	 BBFL Flat
		 LVBP Bumper		 LWTP Tapered Ply	 LWBN Bullnose	 WWTP Tapered Ply	 WWBN Bullnose	 BBBN Bullnose
				 LWFP Flat Ply	 LWPR Prism	 WWFP Flat Ply	 WWPR Prism	











## Complete Table List Pricing

	Top Size	Base Qty.	Model #								
<b>Round</b>  	24	1	BR24RD	1,162	1,162	1,247	1,521	1,811	1,537	1,934	1,790
	30	1	BR30RD	1,266	1,266	1,372	1,714	2,024	1,833	2,175	2,213
	36	1	BR36RD	1,712	1,712	1,837	2,241	2,599	2,285	2,780	3,050
	42	1	BR42RD	1,885	1,885	2,024	2,439	2,883	2,599	3,098	3,952
	48	1	BR48RD	2,304	2,304	2,459	2,918	3,427	3,109	3,683	4,665
	54	1	BR54RD	2,495	2,495	2,675	3,290	4,342	3,527	4,709	-
	60	1	BR60RD	2,798	2,798	2,993	3,495	4,482	4,114	4,871	-
<b>RD Square</b>  	24 24	1	BR2424RS	1,164	1,164	1,258	1,521	1,811	1,537	1,934	1,910
	30 30	1	BR3030RS	1,266	1,266	1,383	1,714	2,024	1,833	2,175	2,371
	36 36	1	BR3636RS	1,712	1,712	1,830	2,222	2,599	2,285	2,780	3,252
	42 42	1	BR4242RS	1,864	1,864	1,996	2,439	2,883	2,599	3,098	4,270
	48 48	1	BR4848RS	2,306	2,306	2,459	2,918	3,427	3,109	3,683	5,037
<b>Square</b>  	24 24	1	BR2424SQ	1,164	1,164	1,258	1,521	1,811	1,537	1,934	1,910
	30 30	1	BR3030SQ	1,266	1,266	1,383	1,714	2,024	1,833	2,175	2,371
	36 36	1	BR3636SQ	1,712	1,712	1,830	2,222	2,599	2,285	2,780	3,252
	42 42	1	BR4242SQ	1,864	1,864	1,996	2,439	2,883	2,599	3,098	4,270
	48 48	1	BR4848SQ	2,306	2,306	2,459	2,918	3,427	3,109	3,683	5,037
<b>Rectangle</b>  	24 30	1	BR2430RE	1,212	1,212	1,294	1,626	1,946	1,764	2,084	2,111
	24 36	1	BR2436RE	1,569	1,569	1,660	2,041	2,352	2,155	2,505	2,650
	24 42	1	BR2442RE	1,628	1,628	1,705	2,112	2,457	2,232	2,617	2,982
	24 48	1	BR2448RE	1,687	1,687	1,784	2,235	2,617	2,374	2,799	3,077
	24 60	2	BR2460RE	2,323	2,323	2,426	2,911	3,344	3,061	3,551	4,036
	24 72	2	BR2472RE	2,422	2,422	2,542	3,077	3,574	3,253	3,813	4,466
	24 84	2	BR2484RE	2,795	2,795	2,907	3,217	4,058	3,412	4,356	4,782
	24 96	2	BR2496RE	2,895	2,895	3,018	3,358	4,265	3,568	4,590	5,097

Continued on next page

## How to Order

Table Model Number							Options	
<b>BR</b> Base Series	<b>4896</b> Top Size	<b>RD</b> Top Shape	<b>WWSQ</b> Top Material Edge Profile	<b>WMW</b> Top Finish	<b>N/A</b> Edge Finish	<b>MBM</b> Base Finish	<b>GMBM</b> Matte Black Grommet	<b>E</b> Location "E"
<p>A BR4896RAWWSQWMWMBM is a Brae series 48" x 96" racetrack table with two black powder coat bases and a wood veneer 1.25" thick top with a 1.25" square wood edge profile.</p>						<p>Edge finish applies when edge material is different from top material.</p>		
						<p>The code: GMBM specifies a matte black 2" diameter metal grommet.</p>		
						<p>The code: E specifies the location of the grommet.</p>		

Solid Surface		Quartz Surface	
Corian® Group A	Corian® Group B	Quartz Group A	Quartz Group B
 C1FL Flat	 C2FL Flat	 Q1FL Flat	 Q2FL Flat
 C1BN Bullnose	 C2BN Bullnose	 Q1BN Bullnose	 Q2BN Bullnose
 C1PR Prism	 C2PR Prism		

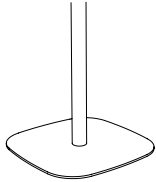

**Options**

**Base Finishes**

Custom Powder Coat (set-up charge)	CPC	693
Polished or Satin Chrome (per base)	use finish code	1,502
Premium Plated (per base)	use finish code	1,733
Stainless Steel (per base)	use finish code	1,733

**Base Options**

Counter, Bar, & Alternate Height (per column)	CH, BH, AH	80
Nylon Octagon Glides (per base)	GNO	42
Custom Top Plate Size	CTPS	693
6" Column (black texture and powder coat)	COL6	235
6" Column (polished or satin chrome)	COLP6	300
6" Column (premium plated)	COLPP6	693
6" Column (veneer)	COLV6	468
Base sizes may vary with quartz tops		

**Top Materials and Finishes**

Any non-standard WCI Laminates (set-up charge)	use manufacturers finish code	173
Premium Laminates	PL	693
Custom Wood Veneer	CWV	693
Stain to Match (set-up charge)	STM	500

**Top Options**

3" Radius Corner (per corner) (Laminate self edge & Corian®)	CRL3	42
3" Wood Radius Corner (per corner) (not available in LWFL and WWFL)	CRW3	100
Custom Size	CS	693
Custom Radius Corner	CRC	100
Custom Shape	CSH	693
Custom Edge Thickness	CET	693

**Grommets**

2" Round Metal Grommet - Matte Black	GMBM	168
2" Round Metal Grommet - Satin Chrome	GMSC	168
2" Round Metal Grommet - Polished Chrome	GMPC	168
2" Round Plastic Grommet - Matte Black	GPMBM	68
Grommet location	use location code	n/c

2,294	2,390	3,838	4,854
2,814	2,932	4,805	6,723
3,821	3,981	6,724	8,238
4,570	4,760	8,087	10,318
5,684	5,921	-	-
6,609	6,885	-	-
7,661	7,981	-	-
-	-	-	-
-	-	-	-
-	-	-	-
-	-	-	-
-	-	-	-
2,133	2,222	2,649	4,224
2,612	2,721	4,029	5,887
3,596	3,746	5,291	7,485
4,301	4,480	6,952	9,147
5,391	5,616	-	-
2,354	2,452	2,629	4,722
2,913	3,035	3,179	5,491
3,126	3,256	3,551	5,821
3,341	3,480	-	-
4,398	4,582	-	-
4,854	5,056	-	-
-	-	-	-
-	-	-	-

Call for pricing

415.621.6656

# BRAE – Dining & Multipurpose











	Laminate Surface						Wood Surface					
	Self Edge	Vinyl Edges	PVC Edges	Wood Edges Group A	Wood Edges Group B	Wood Edges Group A	Wood Edges Group B	Butcher Block				
	LLSE Self Edge	LVFL Flat LVBP Bumper	LPVC PVC	LWFL Flat LWTP Tapered Ply LWFP Flat Ply	LWSQ Square LWBN Bullnose LWPR Prism	WWFL Flat WWTP Tapered Ply WWFP Flat Ply	WWSQ Square WWBN Bullnose WWPR Prism	BBFL Flat BBBN Bullnose				

## Complete Table List Pricing

	Top Size	Base Qty.	Model #									
	30 36	1	BR3036RE	1,648	1,648	1,724	2,132	2,473	2,257	2,639	2,944	
	30 42	1	BR3042RE	1,710	1,710	1,797	2,295	2,678	2,438	2,868	3,364	
	30 48	1	BR3048RE	2,012	2,012	2,110	2,614	3,029	2,769	3,234	3,708	
	30 60	2	BR3060RE	2,439	2,439	2,549	3,094	3,568	3,271	3,802	4,508	
	30 72	2	BR3072RE	2,557	2,557	2,690	3,223	3,762	3,419	4,019	5,031	
	30 84	2	BR3084RE	2,955	2,955	3,069	3,387	4,226	3,600	4,542	5,347	
	30 96	2	BR3096RE	3,077	3,077	3,200	3,550	4,523	3,783	4,876	5,663	
	36 42	1	BR3642RE	1,792	1,792	1,891	2,393	2,813	2,551	3,018	3,733	
	36 48	1	BR3648RE	2,102	2,102	2,206	2,724	3,173	2,890	3,392	4,087	
	36 60	2	BR3660RE	3,171	3,171	3,296	3,810	4,320	4,001	4,574	5,586	
	36 72	2	BR3672RE	3,312	3,312	3,444	4,031	4,606	4,246	4,897	6,192	
	36 84	2	BR3684RE	3,733	3,733	3,853	4,209	5,010	4,450	5,350	6,793	
	36 96	2	BR3696RE	3,874	3,874	4,017	4,391	5,310	4,653	5,686	7,386	
	42 72	2	BR4272RE	3,937	3,937	4,050	4,624	5,302	4,745	5,462	-	
	42 84	2	BR4284RE	4,378	4,378	4,498	4,817	5,693	5,225	6,230	-	
	42 96	2	BR4296RE	4,538	4,538	4,671	5,028	6,081	5,467	6,305	-	
	48 96	2	BR4896RE	4,728	4,728	4,860	5,346	6,470	5,985	6,824	-	
	48 120	2	BR48120RE	5,094	5,094	5,262	5,762	6,861	6,510	7,349	-	
	30 48	1	BR3048RR	2,012	2,012	2,110	2,614	3,029	2,769	3,234	3,708	
	30 60	2	BR3060RR	2,439	2,439	2,549	3,094	3,568	3,271	3,802	4,508	
	30 72	2	BR3072RR	2,557	2,557	2,690	3,223	3,762	3,419	4,019	5,031	
	36 48	1	BR3648RR	2,102	2,102	2,206	2,724	3,173	2,890	3,392	4,087	
	36 60	2	BR3660RR	3,171	3,171	3,296	3,810	4,320	4,001	4,574	5,586	
	36 72	2	BR3672RR	3,312	3,312	3,444	4,031	4,606	4,246	4,897	6,192	

## How to Order

Table Model Number							Options	
<b>BR</b> Base Series	<b>4896</b> Top Size	<b>RD</b> Top Shape	<b>WWSQ</b> Top Material Edge Profile	<b>WMW</b> Top Finish	<b>N/A</b> Edge Finish	<b>MBM</b> Base Finish	<b>GMBM</b> Matte Black Grommet	<b>E</b> Location "E"
A BR4896RAWWSQWMWMBM is a Brae series 48" x 96" racetrack table with two black powder coat bases and a wood veneer 1.25" thick top with a 1.25" square wood edge profile.						Edge finish applies when edge material is different from top material.	The code: GMBM specifies a matte black 2" diameter metal grommet.	The code: E specifies the location of the grommet.

Solid Surface		Quartz Surface	
Corian® Group A	Corian® Group B	Quartz Group A	Quartz Group B
 C1FL Flat	 C2FL Flat	 Q1FL Flat	 Q2FL Flat
 C1BN Bullnose	 C2BN Bullnose	 Q1BN Bullnose	 Q2BN Bullnose
 C1PR Prism	 C2PR Prism		

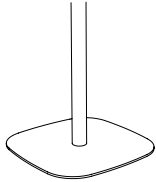

**Options**

Base Finishes		
Custom Powder Coat (set-up charge)	CPC	693
Polished or Satin Chrome (per base)	use finish code	1,502
Premium Plated (per base)	use finish code	1,733
Stainless Steel (per base)	use finish code	

Base Options		
Counter, Bar, & Alternate Height (per column)	CH, BH, AH	80
Nylon Octagon Glides (per base)	GNO	42
Custom Top Plate Size	CTPS	693
6" Column (black texture and powder coat)	COL6	235
6" Column (polished or satin chrome)	COLP6	300
6" Column (premium plated)	COLPP6	693
6" Column (veneer)	COLV6	468
Base sizes may vary with quartz tops		

Top Materials and Finishes		
Any non-standard WCI Laminates (set-up charge)	use manufacturers finish code	173
Premium Laminates	PL	693
Custom Wood Veneer	CWV	693
Stain to Match (set-up charge)	STM	500

Top Options		
3" Radius Corner (per corner) (Laminate self edge & Corian®)	CRL3	42
3" Wood Radius Corner (per corner) (not available in LWFL and WWFL)	CRW3	100
Custom Size	CS	693
Custom Radius Corner	CRC	100
Custom Shape	CSH	693
Custom Edge Thickness	CET	693

Grommets		
2" Round Metal Grommet - Matte Black	GMBM	168
2" Round Metal Grommet - Satin Chrome	GMSC	168
2" Round Metal Grommet - Polished Chrome	GMPC	168
2" Round Plastic Grommet - Matte Black	GPMBM	54
Grommet location	use location code	n/c

3,225	3,359	3,854	6,321
3,487	3,633	4,099	6,487
4,046	4,214	-	-
4,910	5,115	-	-
5,458	5,686	-	-
-	-	-	-
-	-	-	-
4,212	4,388	4,791	7,585
5,107	5,320	-	-
6,155	6,412	-	-
6,781	7,063	-	-
-	-	-	-
-	-	-	-
-	-	-	-
-	-	-	-
-	-	-	-
4,046	4,214	-	-
4,910	5,115	-	-
5,458	5,686	-	-
5,107	5,320	-	-
6,155	6,412	-	-
6,781	7,063	-	-

Call for pricing 415.621.6656

# BRAE DOUBLE – Dining & Multipurpose

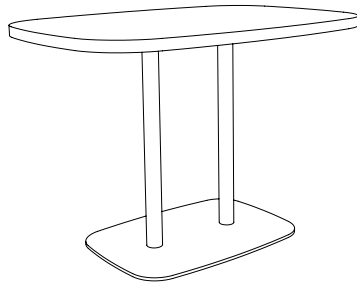

## Laminate Surface

## Wood Surface

Self Edge	Vinyl Edges	PVC Edges	Wood Edges Group A	Wood Edges Group B	Wood Edges Group A	Wood Edges Group B	Butcher Block
LLSE Self Edge	LVFL Flat	LPVC PVC	LWFL Flat	LWSQ Square	WWFL Flat	WWSQ Square	BBFL Flat
	LVBP Bumper		LWTP Tapered Ply	LWBN Bullnose	WWTP Tapered Ply	WWBN Bullnose	BBBN Bullnose
			LWFP Flat Ply	LWPR Prism	WWFP Flat Ply	WWPR Prism	

## Complete Table List Pricing

	Top Size	Base Qty.	Model #								
<b>Rectangle</b> 	24 42	1	BRD2442RE	1,997	1,997	2,075	2,483	2,826	2,603	2,988	3,353
	24 48	1	BRD2448RE	2,058	2,058	2,155	2,605	2,988	2,743	3,170	3,446
	30 42	1	BRD3042RE	2,079	2,079	2,168	2,666	3,048	2,807	3,238	3,735
	30 48	1	BRD3048RE	2,142	2,142	2,239	2,743	3,159	2,899	3,363	3,837
	36 42	1	BRD3642RE	2,161	2,161	2,261	2,762	3,184	2,921	3,388	4,102
	36 48	1	BRD3648RE	2,231	2,231	2,337	2,854	3,304	3,021	3,522	4,216
<b>RD Rectangle</b> 	24 42	1	BRD2442RR	1,997	1,997	2,075	2,483	2,826	2,603	2,988	3,353
	24 48	1	BRD2448RR	2,058	2,058	2,155	2,605	2,988	2,743	3,170	3,446
	30 42	1	BRD3042RR	2,079	2,079	2,168	2,666	3,048	2,807	3,238	3,735
	30 48	1	BRD3048RR	2,142	2,142	2,239	2,743	3,159	2,899	3,363	3,837
	36 42	1	BRD3642RR	2,161	2,161	2,261	2,762	3,184	2,921	3,388	4,102
	36 48	1	BRD3648RR	2,231	2,231	2,337	2,854	3,304	3,021	3,522	4,216

## How to Order

### Table Model Number

<b>BRD</b> Base Series	<b>4272</b> Top Size	<b>RE</b> Top Shape	<b>WWSQ</b> Top Material Edge Profile	<b>WMW</b> Top Finish	<b>N/A</b> Edge Finish	<b>MBM</b> Base Finish
---------------------------	-------------------------	------------------------	---	--------------------------	---------------------------	---------------------------

### Options

<b>GMBM</b> Matte Black Grommet	<b>E</b> Location "E"
---------------------------------------	--------------------------











A BRD3648REWWSQWMWMBM is a Brae Double series 36" x 48" rectangle table with a black powder coat base and a wood veneer 1.25" thick top with a 1.25" square wood edge profile.

Edge finish applies when edge material is different from top material.

The code: GMBM specifies a matte black 2" diameter metal grommet.

The code: E specifies the location of the grommet.

# Dining & Multipurpose – BRAE DOUBLE

Solid Surface		Quartz Surface	
Corian® Group A	Corian® Group B	Quartz Group A	Quartz Group B
 C1FL Flat	 C2FL Flat	 Q1FL Flat	 Q2FL Flat
 C1BN Bullnose	 C2BN Bullnose	 Q1BN Bullnose	 Q2BN Bullnose
 C1PR Prism	 C2PR Prism		

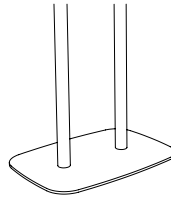

Double Column Base

## Options

### Base Finishes

Custom Powder Coat (set-up charge)	CPC	809
Polished or Satin Chrome (per base)	use finish code	1,502
Premium Plated (per base)	use finish code	1,733
Stainless Steel (per base)	use finish code	1,733

### Base Options

Counter, Bar, & Alternate Height (per column)	CH, BH, AH	80
Nylon Octagon Glides (per base)	GNO	42
Custom Top Plate Size	CTPS	809
6" Column (black texture and powder coat)	COL6	235
6" Column (polished or satin chrome)	COLP6	300
6" Column (premium plated)	COLPP6	809
6" Column (veneer)	COLV6	468
Base sizes may vary with quartz tops		

### Top Materials and Finishes

Any non-standard WCI Laminates (set-up charge)	use manufacturers finish code	173
Premium Laminates	PL	809
Custom Wood Veneer	CWV	809
Stain to Match (set-up charge)	STM	500

### Top Options

3" Radius Corner (per corner) (Laminate self edge & Corian®)	CRL3	42
3" Wood Radius Corner (per corner) (not available in LWFL and WWFL)	CRW3	100
Custom Size	CS	809
Custom Radius Corner	CRC	100
Custom Shape	CSH	809
Custom Edge Thickness	CET	809

### Grommets

2" Round Metal Grommet - Matte Black	GMBM	168
2" Round Metal Grommet - Satin Chrome	GMSC	168
2" Round Metal Grommet - Polished Chrome	GMPC	168
2" Round Plastic Grommet - Matte Black	GPMBM	68
Grommet location	use location code	n/c

3,538	3,685	3,894	6,144
3,753	3,909	-	-
3,898	4,060	4,442	6,810
4,190	4,364	-	-
4,624	4,817	5,134	7,908
5,251	5,470	-	-
3,538	3,685	3,894	6,144
3,753	3,909	-	-
3,898	4,060	4,442	6,810
4,190	4,364	-	-
4,624	4,817	5,134	7,908
5,251	5,470	-	-

Call for pricing

415.621.6656

# CANVAS

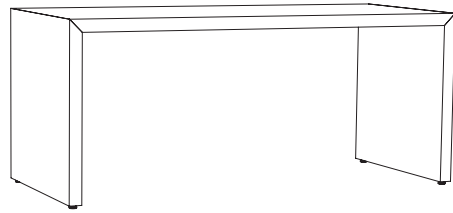

Laminate		Overlay		Clad	
Laminate LAM	Corian® Group A OLC1LAM	Corian® Group B OLC2LAM	Corian® Group A CDC1LAM	Corian® Group B CDC2LAM	

## Complete Table List Pricing

Rectangle	Top Size		Model #	Laminate	Overlay	Clad A	Clad B
	Width	Depth					
	24	60	CA2460RE	4,735	6,120	6,375	9,066
	24	72	CA2472RE	5,222	6,908	7,195	9,961
	24	84	CA2484RE	5,760	7,751	8,074	10,928
	24	96	CA2496RE	6,391	8,666	9,027	11,964
	24	120	CA24120RE	7,484	10,404	10,838	13,832
	30	60	CA3060RE	5,242	6,921	7,209	10,161
	30	72	CA3072RE	5,780	7,821	8,147	11,165
	30	84	CA3084RE	6,373	8,777	9,142	12,238
	30	96	CA3096RE	7,053	9,805	10,214	13,382
	30	120	CA30120RE	8,249	11,768	12,258	15,462
	36	60	CA3660RE	5,809	8,180	8,521	12,085
	36	72	CA3672RE	6,399	9,261	9,647	13,275
	36	84	CA3684RE	7,042	10,375	10,808	14,535
	36	96	CA3696RE	7,773	11,588	12,071	15,866
	36	120	CA36120RE	9,024	13,901	14,480	18,311
	42	60	CA4260RE	6,376	9,049	9,426	13,409
	42	72	CA4272RE	7,017	10,222	10,648	14,706
	42	84	CA4284RE	7,713	11,479	11,957	16,072
	42	96	CA4296RE	8,497	12,819	13,353	17,511
	42	120	CA42120RE	9,818	15,348	15,987	20,170

## How to Order

### Table Model Number

<b>CA</b> Table Series	<b>3684</b> Top Size	<b>RE</b> Top Shape	<b>OLCVEN</b> Material & Style	<b>WNW</b> Wood Veneer Finish	<b>CGW</b> Corian Overlay
---------------------------	-------------------------	------------------------	-----------------------------------	-------------------------------------	---------------------------------

### Options

<b>MIN2-B</b> Specified power unit.
--

A CA3684REOLCVENWNWCGW is a Canvas series 36" x 84" standard height rectangle table in Natural Walnut wood veneer with a Corian® Glacier White overlay top.

MIN2-B is an in-surface power unit with one power and one USB charger.

Wood	Overlay		Clad	
Veneer	Corian® Group A	Corian® Group B	Corian® Group A	Corian® Group B
VEN	OLC1VEN	OLC2VEN	CDC1VEN	CDC2VEN

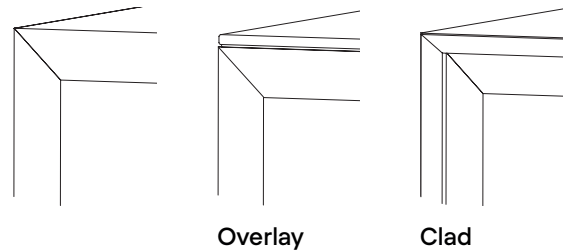

5,796	7,102	7,398	9,957	10,372
6,386	8,006	8,339	10,959	11,415
7,053	8,989	9,364	12,041	12,543
7,783	10,040	10,458	13,188	13,738
9,014	11,938	12,436	15,280	15,917
6,352	7,834	8,161	11,068	11,529
6,999	8,848	9,217	12,178	12,686
7,721	9,941	10,355	13,369	13,926
8,509	11,100	11,562	14,624	15,234
9,852	13,215	13,765	16,933	17,639
6,984	9,096	9,475	13,203	13,753
7,689	10,271	10,699	14,502	15,106
8,468	11,543	12,024	15,880	16,541
9,311	12,891	13,428	17,325	18,047
10,761	15,348	15,987	19,995	20,829
7,619	9,925	10,339	14,564	15,170
8,378	11,209	11,677	15,971	16,636
9,215	12,602	13,127	17,458	18,186
10,114	14,073	14,659	19,012	19,804
11,656	16,691	17,387	21,883	22,795

**Options**

**Base Options**

Counter & Bar Height	CH & BH	pages 69-70
Alternate Height	AH	

**Top Materials and Finishes**

Any non-standard WCI Laminates (set-up charge)	use manufacturers finish code	173
Premium Laminates	PL	
Custom Wood Veneer	CWV	
Custom Overlay Material	NSF	
Stain to Match (set-up charge)	STM	500

**Top Options**

Custom Size	CS	
-------------	----	--

**Power, Data, & Wire Management**

Wire Management	Pages 134 - 235
Power & Data	Pages 236-237

Call for pricing

415.621.6656

# CANVAS— Counter

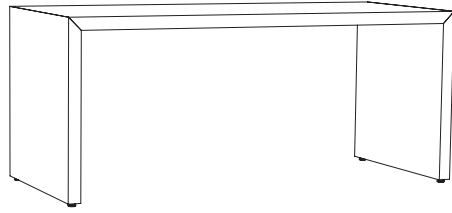

Laminate		Overlay		Clad	
Laminate LAM	Corian® Group A OLC1LAM	Corian® Group B OLC2LAM	Corian® Group A CDC1LAM	Corian® Group B CDC2LAM	

## Complete Table List Pricing

Rectangle	Top Size		Model #					
	24	60		5,040	6,395	6,662	9,838	10,248
	24	72	CA2472RE	5,526	7,183	7,483	10,734	11,182
	24	84	CA2484RE	6,065	8,027	8,361	11,700	12,188
	24	96	CA2496RE	6,695	8,944	9,317	12,738	13,269
	24	120	CA24120RE	7,788	10,683	11,128	14,595	15,203
	30	60	CA3060RE	5,606	7,253	7,556	11,060	11,521
	30	72	CA3072RE	6,145	8,152	8,492	12,062	12,565
	30	84	CA3084RE	6,737	9,108	9,488	13,135	13,683
	30	96	CA3096RE	7,417	10,138	10,560	14,280	14,875
	30	120	CA30120RE	8,613	12,100	12,605	16,352	17,034
	36	60	CA3660RE	6,234	8,568	8,925	13,108	13,654
	36	72	CA3672RE	6,824	9,648	10,050	14,298	14,894
	36	84	CA3684RE	7,467	10,761	11,209	15,558	16,206
	36	96	CA3696RE	8,199	11,975	12,474	16,889	17,593
	36	120	CA36120RE	9,449	14,288	14,883	19,326	20,131
	42	60	CA4260RE	6,861	9,491	9,886	14,556	15,162
	42	72	CA4272RE	7,503	10,664	11,109	15,852	16,512
	42	84	CA4284RE	8,199	11,921	12,418	17,221	17,938
	42	96	CA4296RE	8,983	13,258	13,811	18,658	19,436
	42	120	CA42120RE	10,304	15,753	16,409	21,245	22,131

## How to Order

### Table Model Number

<b>CA</b> Table Series	<b>3684</b> Top Size	<b>RE</b> Top Shape	<b>OLCVEN</b> Material & Style	<b>WNW</b> Wood Veneer Finish	<b>CGW</b> Corian Overlay
---------------------------	-------------------------	------------------------	-----------------------------------	-------------------------------------	---------------------------------

### Options

<b>BH</b> Bar Height	<b>MIN2-A</b> Specified power unit.
-------------------------	--

A CA3684REOLCVENWNWCGW-BH-MIN2-A is a Canvas series 36" x 84" bar height rectangle table in Natural Walnut wood veneer with a Corian® Glacier White overlay top with a Byrne® Mini-Tap® on surface power unit.

To specify Counter Height use code CH.

MIN2-B is an in-surface power unit with one power and one USB charger.

Wood	Overlay		Clad	
Veneer	Corian® Group A	Corian® Group B	Corian® Group A	Corian® Group B
VEN	OLC1VEN	OLC2VEN	CDC1VEN	CDC2VEN

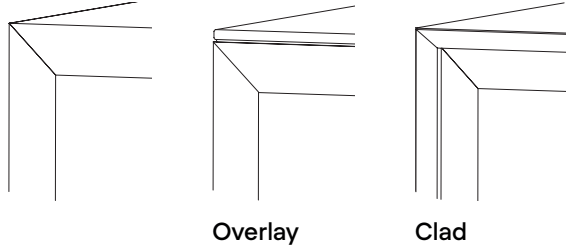

**Options**

Top Materials and Finishes		
Any non-standard WCI Laminates (set-up charge)	use manufacturers finish code	173
Premium Laminates	PL	🕒
Custom Wood Veneer	CWV	🕒
Custom Overlay Material	NSF	🕒
Stain to Match (set-up charge)	STM	500

Top Options		
Custom Size	CS	🕒

Power, Data, & Wire Management		
Wire Management		Pages 134 -235
Power & Data		Pages 236-237

6,154	7,370	7,677	10,782	11,231
6,744	8,275	8,620	11,784	12,275
7,410	9,260	9,646	12,865	13,401
8,143	10,311	10,740	14,014	14,598
9,413	12,207	12,716	16,093	16,764
6,774	8,147	8,487	12,021	12,522
7,421	9,159	9,541	13,131	13,679
8,146	10,252	10,680	14,321	14,917
8,932	11,413	11,888	15,577	16,226
10,346	13,531	14,095	17,874	18,619
7,475	9,451	9,845	14,323	14,920
8,179	10,626	11,069	15,622	16,273
8,958	11,898	12,394	17,002	17,710
9,802	13,246	13,798	18,447	19,216
11,323	15,707	16,361	21,104	21,984
8,175	10,322	10,753	15,811	16,470
8,935	11,607	12,090	17,218	17,936
9,769	13,001	13,542	18,706	19,485
10,670	14,470	15,073	20,259	21,104
12,234	17,103	17,816	23,121	24,085

🕒 Call for pricing 415.621.6656

# CANVAS— Bar Height

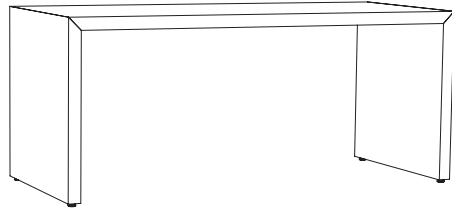

Laminate	Overlay		Clad	
Laminate LAM	Corian® Group A OLC1LAM	Corian® Group B OLC2LAM	Corian® Group A CDC1LAM	Corian® Group B CDC2LAM

## Complete Table List Pricing

Rectangle	Top Size		Model #	5,309	6,641	6,918	10,543	10,982
	24	60						
	24	60	CA2460RE	5,309	6,641	6,918	10,543	10,982
	24	72	CA2472RE	5,796	7,429	7,739	11,439	11,916
	24	84	CA2484RE	6,336	8,271	8,616	12,405	12,922
	24	96	CA2496RE	6,964	9,189	9,571	13,443	14,003
	24	120	CA24120RE	8,057	10,927	11,382	15,238	15,873
	30	60	CA3060RE	5,928	7,545	7,860	11,871	12,365
	30	72	CA3072RE	6,467	8,444	8,796	12,874	13,410
	30	84	CA3084RE	7,059	9,400	9,791	13,947	14,528
	30	96	CA3096RE	7,739	10,429	10,864	15,090	15,719
	30	120	CA30120RE	8,935	12,391	12,907	17,101	17,813
	36	60	CA3660RE	6,607	8,906	9,277	14,026	14,611
	36	72	CA3672RE	7,197	9,987	10,403	15,214	15,848
	36	84	CA3684RE	7,841	11,100	11,562	16,476	17,163
	36	96	CA3696RE	8,572	12,314	12,827	17,808	18,550
	36	120	CA36120RE	9,819	14,626	15,235	20,181	21,022
	42	60	CA4260RE	7,285	9,876	10,288	15,581	16,231
	42	72	CA4272RE	7,927	11,048	11,509	16,878	17,581
	42	84	CA4284RE	8,622	12,306	12,819	18,245	19,005
	42	96	CA4296RE	9,405	13,644	14,212	19,684	20,504
	42	120	CA42120RE	10,729	16,137	16,809	22,272	23,200

## How to Order

### Table Model Number

CA Table Series	3684 Top Size	RE Top Shape	OLCVEN Material & Style	WNW Wood Veneer Finish	CGW Corian Overlay
--------------------	------------------	-----------------	----------------------------	------------------------------	--------------------------

### Options

BH Bar Height	MIN2-A Specified power unit.
------------------	---------------------------------

A CA3684REOLCVENWNWCGW-BH-MIN2-A is a Canvas series 36" x 84" bar height rectangle table in Natural Walnut wood veneer with a Corian® Glacier White overlay top with a Byrne® Mini-Tap® on surface power unit.

To specify Counter Height use code CH.

MIN2-B is an in-surface power unit with one power and one USB charger.

Wood	Overlay		Clad	
Veneer	Corian® Group A	Corian® Group B	Corian® Group A	Corian® Group B
VEN	OLC1VEN	OLC2VEN	CDC1VEN	CDC2VEN

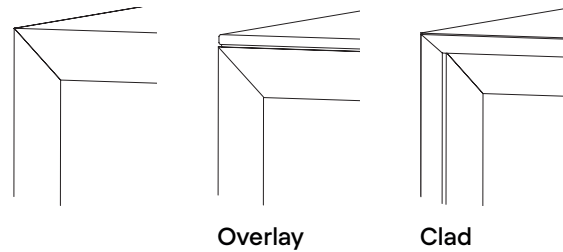

**Options**

**Top Materials and Finishes**

Any non-standard WCI Laminates (set-up charge)	use manufacturers finish code	173
Premium Laminates	PL	🕒
Custom Wood Veneer	CWV	🕒
Custom Overlay Material	NSF	🕒
Stain to Match (set-up charge)	STM	500

**Top Options**

Custom Size	CS	🕒
-------------	----	---

**Power, Data, & Wire Management**

Wire Management	Pages 134 -235
Power & Data	Pages 236-237

6,473	9,421	9,813	11,864	12,359
7,062	10,456	10,891	12,875	13,412
7,730	11,570	12,052	13,964	14,546
8,460	12,751	13,283	15,121	15,751
9,755	14,909	15,531	17,205	17,922
7,150	10,729	11,176	13,350	13,907
7,796	11,914	12,411	14,480	15,084
8,519	13,179	13,728	15,690	16,343
9,307	14,511	15,115	16,965	17,672
10,745	16,973	17,680	19,296	20,100
7,905	12,566	13,090	15,938	16,602
8,609	13,954	14,535	17,267	17,986
9,389	15,440	16,083	18,675	19,454
10,233	17,000	17,709	20,152	20,992
11,777	19,884	20,713	22,868	23,821
8,662	13,970	14,552	17,672	18,409
9,422	15,507	16,154	19,123	19,920
10,259	17,156	17,871	20,653	21,513
11,158	18,880	19,667	22,247	23,174
12,731	20,827	21,695	25,187	26,236

🕒 Call for pricing

415.621.6656

# DISC – Dining & Multipurpose

	Laminate Surface				Wood Surface			
	Self Edge	Vinyl Edges	PVC Edges	Wood Edges Group A	Wood Edges Group B	Wood Edges Group A	Wood Edges Group B	Butcher Block
	LLSE Self Edge	LVFL Flat LVBP Bumper	LPVC PVC	LWFL Flat LWTP Tapered Ply	LWSQ Square LWFP Flat Ply	WWFL Flat WWTP Tapered Ply	WWSQ Square WWPR Prism	BBFL Flat BBBN Bullnose











## Complete Table List Pricing

	Top Size	Base Qty.	Model #									
Round 	24	1	DI24RD	1,151	1,151	1,236	1,507	1,794	1,523	1,916	1,774	
	30	1	DI30RD	1,255	1,255	1,359	1,698	2,006	1,816	2,155	2,193	
	36	1	DI36RD	1,696	1,696	1,820	2,220	2,575	2,263	2,754	3,021	
	42	1	DI42RD	1,868	1,868	2,006	2,416	2,857	2,575	3,070	3,916	
	48	1	DI48RD	2,282	2,282	2,436	2,891	3,396	3,080	3,649	4,622	
	54	1	DI54RD	2,472	2,472	2,651	3,259	4,302	3,495	4,666	-	
	60	1	DI60RD	2,772	2,772	2,965	3,463	4,441	4,076	4,826	-	
Oval 	36	72	2	DI3672OV	2,722	2,722	2,808	3,164	3,543	3,457	3,825	-
	42	54	2	DI4254OV	2,682	2,682	2,729	3,078	3,635	3,334	3,738	-
	42	78	2	DI4278OV	3,792	3,792	3,863	4,192	4,567	4,435	4,854	-
	42	84	2	DI4284OV	3,888	3,888	3,979	4,277	4,704	4,526	5,009	-
	48	78	2	DI4878OV	4,423	4,423	4,521	4,808	5,233	5,068	5,545	-
	48	96	2	DI4896OV	4,723	4,723	4,819	5,061	5,524	5,678	6,218	-
RD Square 	24	24	1	DI2424RS	1,152	1,152	1,246	1,505	1,794	1,523	1,916	1,893
	30	30	1	DI3030RS	1,255	1,255	1,369	1,698	2,006	1,816	2,155	2,350
	36	36	1	DI3636RS	1,696	1,696	1,811	2,201	2,575	2,263	2,754	3,221
	42	42	1	DI4242RS	1,847	1,847	1,977	2,416	2,857	2,575	3,070	4,230
	48	48	1	DI4848RS	2,285	2,285	2,436	2,892	3,396	3,081	3,650	4,990
Square 	24	24	1	DI2424SQ	1,152	1,152	1,246	1,505	1,794	1,523	1,916	1,893
	30	30	1	DI3030SQ	1,255	1,255	1,369	1,698	2,006	1,816	2,155	2,350
	36	36	1	DI3636SQ	1,696	1,696	1,811	2,201	2,575	2,263	2,754	3,221
	42	42	1	DI4242SQ	1,847	1,847	1,977	2,416	2,857	2,575	3,070	4,230
	48	48	1	DI4848SQ	2,285	2,285	2,436	2,892	3,396	3,081	3,650	4,990

Continued on next page

## How to Order

Table Model Number							Options	
DI Base Series	4896 Top Size	RA Top Shape	WWSQ Top Material Edge Profile	WMW Top Finish	N/A Edge Finish	MBM Base Finish	GMBM Matte Black Grommet	E Location "E"
A DI4896RAWWSQWMWMBM is a Disc series 48" x 96" racetrack table with two black powder coat round bases and a wood veneer 1.25" thick top with a 1.25" square wood edge profile.					Edge finish applies when edge material is different from top material.		The code: GMBM specifies a matte black 2" diameter metal grommet.	The code: E specifies the location of the grommet.

Solid Surface		Quartz Surface	
Corian® Group A	Corian® Group B	Quartz Group A	Quartz Group B
 C1FL Flat	 C2FL Flat	 Q1FL Flat	 Q2FL Flat
 C1BN Bullnose	 C2BN Bullnose	 Q1BN Bullnose	 Q2BN Bullnose
 C1PR Prism	 C2PR Prism		

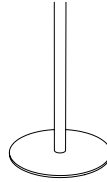

**Options**

**Base Finishes**

Custom Powder Coat (set-up charge)	CPC	693
Polished or Satin Chrome (per base)	use finish code	1,502
Premium Plated (per base)	use finish code	1,733
Stainless Steel (per base)	use finish code	1,733

**Base Options**

Counter, Bar, & Alternate Height (per column)	CH, BH, AH	80
Nylon Octagon Glides (per base)	GNO	42
Custom Top Plate Size	CTPS	1
6" Column (black texture and powder coat)	COL6	235
6" Column (polished or satin chrome)	COLP6	300
6" Column (premium plated)	COLPP6	1
6" Column (veneer)	COLV6	468
Base sizes may vary with quartz tops		

**Top Materials and Finishes**

Any non-standard WCI Laminates (set-up charge)	use manufacturers finish code	173
Premium Laminates	PL	1
Custom Wood Veneer	CWV	1
Stain to Match (set-up charge)	STM	500

**Top Options**

3" Radius Corner (per corner) (Laminate self edge & Corian®)	CRL3	42
3" Wood Radius Corner (per corner) (not available in LWFL and WWFL)	CRW3	100
Custom Size	CS	1
Custom Radius Corner	CRC	100
Custom Shape	CSH	1
Custom Edge Thickness	CET	1

**Grommets**

2" Round Metal Grommet - Matte Black	GMBM	168
2" Round Metal Grommet - Satin Chrome	GMSC	168
2" Round Metal Grommet - Polished Chrome	GMPC	168
2" Round Plastic Grommet - Matte Black	GPMBM	54
Grommet location	use location code	n/c

2,294	2,390	3,838	4,854
2,814	2,932	4,805	6,723
3,821	3,981	6,724	8,238
4,570	4,760	8,087	10,318
5,684	5,921	-	-
6,609	6,885	-	-
7,661	7,981	-	-
-	-	-	-
-	-	-	-
-	-	-	-
-	-	-	-
-	-	-	-
-	-	-	-
-	-	-	-
-	-	-	-
-	-	-	-
-	-	-	-
2,133	2,222	2,649	4,224
2,612	2,721	4,028	5,886
3,596	3,746	5,292	7,485
4,299	4,478	6,952	9,147
5,390	5,614	-	-

1 Call for pricing

415.621.6656

# DISC – Dining & Multipurpose

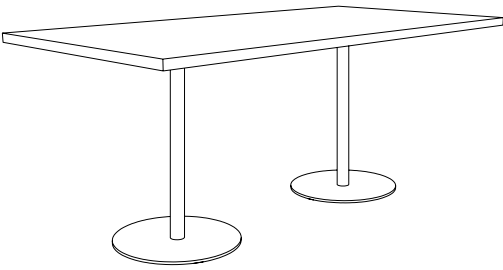

Laminate Surface				Wood Surface			
Self Edge	Vinyl Edges	PVC Edges	Wood Edges Group A	Wood Edges Group B	Wood Edges Group A	Wood Edges Group B	Butcher Block
LLSE Self Edge	LVFL Flat LVBP Bumper	LPVC PVC	LWFL Flat LWTP Tapered Ply LWFP Flat Ply	LWSQ Square LWBN Bullnose LWPR Prism	WWFL Flat WWTP Tapered Ply WWFP Flat Ply	WWSQ Square WWBN Bullnose WWPR Prism	BBFL Flat BBBN Bullnose

## Complete Table List Pricing











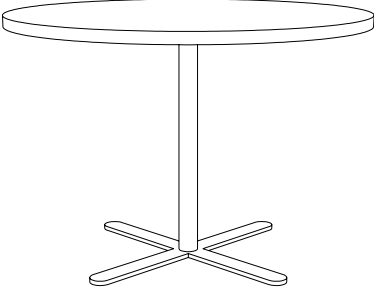







	Top Size		Base Qty.	Model #								
Rectangle 	24	30	1	DI2430RE	1,202	1,202	1,282	1,610	1,927	1,747	2,063	2,092
	24	36	1	DI2436RE	1,556	1,556	1,645	2,022	2,330	2,135	2,482	2,626
	24	42	1	DI2442RE	1,611	1,611	1,689	2,093	2,433	2,212	2,594	2,954
	24	48	1	DI2448RE	1,673	1,673	1,768	2,215	2,594	2,352	2,773	3,048
	24	60	2	DI2460RE	2,301	2,301	2,403	2,882	3,313	3,033	3,518	3,998
	24	72	2	DI2472RE	2,399	2,399	2,519	3,048	3,540	3,223	3,777	4,424
	24	84	2	DI2484RE	2,769	2,769	2,880	3,187	4,019	3,380	4,317	4,737
	24	96	2	DI2496RE	2,867	2,867	2,991	3,327	4,225	3,535	4,548	5,049
	30	36	1	DI3036RE	1,632	1,632	1,709	2,114	2,451	2,236	2,614	2,917
	30	42	1	DI3042RE	1,694	1,694	1,782	2,274	2,653	2,415	2,841	3,333
	30	48	1	DI3048RE	1,994	1,994	2,089	2,589	3,000	2,745	3,204	3,673
	30	60	2	DI3060RE	2,416	2,416	2,525	3,065	3,535	3,240	3,766	4,467
	30	72	2	DI3072RE	2,533	2,533	2,665	3,193	3,728	3,387	3,982	4,986
	30	84	2	DI3084RE	2,928	2,928	3,040	3,356	4,187	3,566	4,498	5,298
	30	96	2	DI3096RE	3,048	3,048	3,171	3,517	4,481	3,749	4,830	5,610
	36	42	1	DI3642RE	1,774	1,774	1,874	2,369	2,786	2,527	2,990	3,698
	36	48	1	DI3648RE	2,082	2,082	2,187	2,699	3,145	2,864	3,362	4,048
	36	60	2	DI3660RE	3,141	3,141	3,264	3,775	4,280	3,964	4,531	5,535
	36	72	2	DI3672RE	3,281	3,281	3,413	3,994	4,563	4,207	4,852	6,135
	36	84	2	DI3684RE	3,698	3,698	3,817	4,171	4,963	4,409	5,300	6,730
	36	96	2	DI3696RE	3,838	3,838	3,979	4,350	5,261	4,610	5,633	7,317
	42	72	2	DI4272RE	3,902	3,902	4,012	4,581	5,254	4,700	5,412	-
	42	84	2	DI4284RE	4,336	4,336	4,456	4,773	5,640	5,176	6,172	-
	42	96	2	DI4296RE	4,497	4,497	4,628	4,981	6,025	5,418	6,246	-
	48	96	2	DI4896RE	4,686	4,686	4,814	5,297	6,410	5,930	6,761	-
	48	120	2	DI48120RE	5,047	5,047	5,213	5,708	6,797	6,450	7,281	-

## How to Order





Table Model Number							Options	
DI Base Series	3642 Top Size	RE Top Shape	WWSQ Top Material Edge Profile	WMW Top Finish	N/A Edge Finish	MBM Base Finish	GMBM Matte Black Grommet	E Location "E"
A DI3642REWWSQWMWMBM is a Disc series 36" x 42" rectangle table with a black powder coat round base and a wood veneer 1.25" thick top with a 1.25" square wood edge profile.					Edge finish applies when edge material is different from top material.		The code: GMBM specifies a matte black 2" diameter metal grommet.	The code: E specifies the location of the grommet.



# DUNHILL – Dining & Multipurpose

	Laminate Surface				Wood Surface			
	Self Edge	Vinyl Edges	PVC Edges	Wood Edges Group A	Wood Edges Group B	Wood Edges Group A	Wood Edges Group B	Butcher Block
	 LLSE Self Edge	 LVFL Flat	 LPVC PVC	 LWFL Flat	 LWSQ Square	 WWFL Flat	 WWSQ Square	 BBFL Flat
		 LVBP Bumper		 LWTP Tapered Ply	 LWBN Bullnose	 WWTP Tapered Ply	 WWBN Bullnose	 BBBN Bullnose
				 LWFP Flat Ply	 LWPR Prism	 WWFP Flat Ply	 WWPR Prism	

## Complete Table List Pricing







	Top Size		Base Qty.	Base Style	Model #								
<b>Round</b> 	24		1	X	DUX24RD	1,230	1,230	1,315	1,588	1,878	1,605	2,003	1,858
	30		1	X	DUX30RD	1,465	1,465	1,569	1,913	2,223	2,031	2,374	2,412
	36		1	X	DUX36RD	1,729	1,729	1,852	2,257	2,616	2,301	2,797	3,066
	42		1	X	DUX42RD	1,902	1,902	2,041	2,456	2,899	2,616	3,115	3,969
	48		1	X	DUX48RD	2,207	2,207	2,364	2,823	3,332	3,014	3,588	4,570
	54		1	XH	DUXH54RD	2,522	2,522	2,703	3,317	4,369	3,554	4,737	-
	60		1	XH	DUXH60RD	2,825	2,825	3,020	3,522	4,510	4,141	4,898	-
<b>Oval</b> 	36	72	2	T	DUT3672OV	2,382	2,382	2,469	2,826	3,209	3,123	3,495	-
	42	54	2	T	DUT4254OV	2,342	2,342	2,389	2,741	3,303	3,000	3,407	-
	42	78	2	T	DUT4278OV	2,844	2,844	2,915	3,248	3,626	3,493	3,916	-
	42	84	2	T	DUT4284OV	2,940	2,940	3,033	3,334	3,765	3,584	4,072	-
	48	78	2	TT	DUTT4878OV	3,218	3,218	3,318	3,607	4,036	3,871	4,350	-
	48	96	2	TT	DUTT4896OV	3,521	3,521	3,617	3,862	4,329	4,485	5,030	-
<b>RD Square</b> 	24	24	1	X	DUX2424RS	1,232	1,232	1,327	1,588	1,879	1,605	2,003	1,978
	30	30	1	X	DUX3030RS	1,464	1,464	1,580	1,913	2,223	2,031	2,372	2,571
	36	36	1	X	DUX3636RS	1,729	1,729	1,845	2,238	2,616	2,301	2,797	3,268
	42	42	1	X	DUX4242RS	2,009	2,009	2,141	2,584	3,028	2,744	3,243	4,415
	48	48	1	X	DUX4848RS	2,211	2,211	2,364	2,823	3,332	3,014	3,588	4,942
<b>Square</b> 	24	24	1	X	DUX2424SQ	1,232	1,232	1,327	1,588	1,879	1,605	2,003	1,978
	30	30	1	X	DUX3030SQ	1,464	1,464	1,580	1,913	2,223	2,031	2,372	2,571
	36	36	1	X	DUX3636SQ	1,729	1,729	1,845	2,238	2,616	2,301	2,797	3,268
	42	42	1	X	DUX4242SQ	2,009	2,009	2,141	2,584	3,028	2,744	3,243	4,415
	48	48	1	X	DUX4848SQ	2,211	2,211	2,364	2,823	3,332	3,014	3,588	4,942

Continued on next page

## How to Order

Table Model Number							Options
<b>DUX</b> Base Series	<b>36</b> Top Size	<b>RD</b> Top Shape	<b>WWSQ</b> Top Material Edge Profile	<b>WMW</b> Top Finish	<b>N/A</b> Edge Finish	<b>MBM</b> Base Finish	<b>AH</b> Alternate Height Base
A DUX36RDWWSQWMWMBM is a Dunhill series 36" round table with a black powder coat X-base and a wood veneer 1.25" thick top with a 1.25" square wood edge profile.					Edge finish applies when edge material is different from top material.		The code: AH specifies alternate height base.

Solid Surface

Corian® Group A	Corian® Group B
 C1FL Flat	 C2FL Flat
 C1BN Bullnose	 C2BN Bullnose
 C1PR Prism	 C2PR Prism

2,369	2,468
3,035	3,161
3,839	3,999
4,587	4,778
5,577	5,809
6,640	6,916
7,692	8,012
-	-
-	-
-	-
-	-
-	-
-	-
-	-
-	-
-	-
-	-
-	-
-	-
-	-
2,208	2,300
2,833	2,951
3,614	3,765
4,460	4,646
5,284	5,504

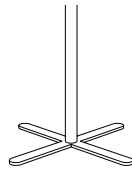

X, XH Base

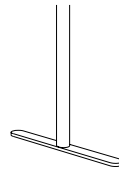

T Base

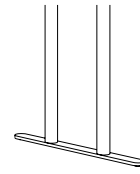

TT Base

Options

Base Finishes

Custom Powder Coat (set-up charge)	CPC	📞
Polished or Satin Chrome (per X base)	use finish code	434
Polished or Satin Chrome (T & TT base, per column)	use finish code	217
Premium Plated (per X base)	use finish code	751
Premium Plated (T & TT base, per column)	use finish code	404
Stainless Steel (per base)	use finish code	1,733

Base Options

Counter, Bar, & Alternate Height (per column)	CH, BH, AH	80
Super Level Glides (per base)	GSL	42
Locking Casters 2" Twin Wheel (qty. 4)	TWC2	68
Tilt-top - (standard cable release)	TMX/TMT	📞
Folding	FM	📞

Top Materials and Finishes

Any non-standard WCI Laminates (set-up charge)	use manufacturers finish code	173
Premium Laminates	PL	📞
Custom Wood Veneer	CWV	📞
Stain to Match (set-up charge)	STM	500

Top Options

3" Radius Corner (per corner) (Laminate self edge & Corian®)	CRL3	42
3" Wood Radius Corner (per corner) (not available in LWFL and WWFL)	CRW3	100
Custom Radius Corner	CRC	100
Custom Size	CS	📞
Custom Shape	CSH	📞
Custom Edge Thickness	CET	📞
Ganging Clips (1 set includes 2 male and 2 female clips)	GC	180

Grommets

2" Round Metal Grommet - Matte Black	GMBM	168
2" Round Metal Grommet - Satin Chrome	GMSC	168
2" Round Metal Grommet - Polished Chrome	GMPC	168
2" Round Plastic Grommet - Matte Black	GPMBM	54
Grommet location	use location code	n/c

Power, Data, & Wire Management

Wire management	Pages 200-203
Power & data	Pages 236-237

📞 Call for pricing

415.621.6656

# DUNHILL – Dining & Multipurpose

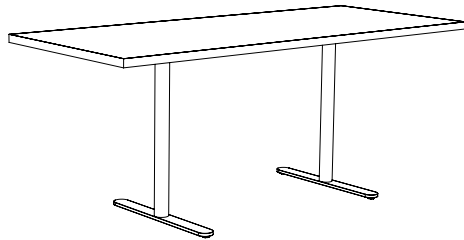

## Laminate Surface

## Wood Surface

Self Edge	Vinyl Edges	PVC Edges	Wood Edges Group A	Wood Edges Group B	Wood Edges Group A	Wood Edges Group B	Butcher Block
LLSE Self Edge	LVFL Flat	LPVC PVC	LWFL Flat	LWSQ Square	WWFL Flat	WWSQ Square	BBFL Flat
	LVBP Bumper		LWTP Tapered Ply	LWBN Bullnose	WWTP Tapered Ply	WWBN Bullnose	BBBN Bullnose
			LWFP Flat Ply	LWPR Prism	WWFP Flat Ply	WWPR Prism	

## Complete Table List Pricing

	Top Size	Base Qty.	Base Style	Model #	1,516	1,516	1,603	1,805	2,233	1,917	2,282	2,427
Rectangle 	18 48	2	T	DUT1848RE	1,516	1,516	1,603	1,805	2,233	1,917	2,282	2,427
	18 60	2	T	DUT1860RE	1,600	1,600	1,704	1,942	2,427	2,053	2,527	2,544
	18 72	2	T	DUT1872RE	1,681	1,681	1,794	2,087	2,622	2,204	2,770	2,740
	18 84	2	T	DUT1884RE	1,942	1,942	2,031	2,336	2,865	2,498	3,090	3,012
	18 96	2	T	DUT1896RE	2,087	2,087	2,167	2,435	3,059	2,605	3,269	3,206
	24 30	1	X	DUX2430RE	1,410	1,410	1,492	1,824	2,143	1,961	2,281	2,308
	24 36	1	X	DUX2436RE	1,586	1,586	1,676	2,058	2,369	2,170	2,521	2,667
	24 42	1	X	DUX2442RE	1,643	1,643	1,721	2,128	2,472	2,249	2,635	2,999
	24 48	1	X	DUX2448RE	1,705	1,705	1,801	2,252	2,635	2,390	2,816	3,094
	24 60	2	T	DUT2460RE	1,713	1,713	1,816	2,300	2,735	2,452	2,941	3,426
	24 72	2	T	DUT2472RE	1,813	1,813	1,933	2,467	2,964	2,643	3,203	3,856
	24 84	2	T	DUT2484RE	2,186	2,186	2,298	2,608	3,448	2,802	3,748	4,172
	24 96	2	T	DUT2496RE	2,286	2,286	2,409	2,749	3,657	2,958	3,981	4,487
	30 36	1	X	DUX3036RE	1,664	1,664	1,742	2,149	2,489	2,274	2,654	2,960
	30 42	2	T	DUT3042RE	1,746	1,746	1,835	2,332	2,715	2,475	2,905	3,402
	30 48	1	X	DUX3048RE	1,917	1,917	2,014	2,519	2,933	2,674	3,138	3,613
	30 60	2	T	DUT3060RE	1,947	1,947	2,056	2,602	3,076	2,779	3,310	4,017
	30 72	2	T	DUT3072RE	2,065	2,065	2,198	2,731	3,271	2,927	3,527	4,541
	30 84	2	T	DUT3084RE	2,464	2,464	2,577	2,895	3,734	3,108	4,049	4,855
	30 96	2	T	DUT3096RE	2,585	2,585	2,709	3,058	4,031	3,292	4,384	5,170
	36 42	2	T	DUT3642RE	1,953	1,953	2,054	2,554	2,975	2,713	3,180	3,894
	36 48	2	T	DUT3648RE	2,023	2,023	2,129	2,646	3,096	2,813	3,315	4,008
	36 60	2	T	DUT3660RE	2,187	2,187	2,311	2,826	3,336	3,018	3,590	4,604
	36 72	2	T	DUT3672RE	2,328	2,328	2,462	3,047	3,622	3,262	3,913	5,208
36 84	2	T	DUT3684RE	2,749	2,749	2,869	3,227	4,026	3,467	4,366	5,809	
36 96	2	TT	DUTT3696RE	3,109	3,109	3,252	3,626	4,545	3,888	4,921	6,621	

Continued on next page

\*T-bases can be specified on 30" x 42" and 30" x 48" rectangle tables, please refer to Base Only Pricing and Top Only Pricing.

X-bases are recommended for dining applications.

## How to Order







Table Model Number							Options
DUT Base Series	3672 Top Size	RA Top Shape	WWSQ Top Material Edge Profile	WMW Top Finish	N/A Edge Finish	MBM Base Finish	TWC2 Casters

A DUT3672RAWWSQWMWMBM is a Dunhill series 36"x 72" racetrack table with two black powder coated T-bases and a wood veneer 1.25" thick top with a 1.25" square wood edge profile.

Edge finish applies when edge material is different from top material.

The code: TWC2 specifies 2" twin wheel locking casters.

Solid Surface

Corian® Group A	Corian® Group B
 C1FL Flat	 C2FL Flat
 C1BN Bullnose	 C2BN Bullnose
 C1PR Prism	 C2PR Prism

-	-
-	-
-	-
-	-
-	-
2,574	2,681
2,930	3,053
3,143	3,274
3,359	3,499
3,721	3,876
4,176	4,351
-	-
-	-
3,242	3,377
3,528	3,675
3,939	4,103
4,365	4,547
4,912	5,116
-	-
-	-
4,394	4,577
5,020	5,229
5,062	5,273
5,688	5,925
-	-
-	-

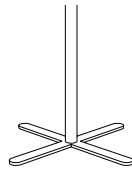

X, XH Base

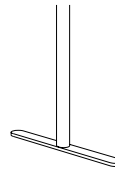

T Base

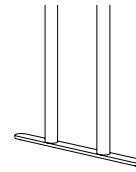

TT Base

Options

Base Finishes

Custom Powder Coat (set-up charge)	CPC	📞
Polished or Satin Chrome (per X base)	use finish code	434
Polished or Satin Chrome (T & TT base, per column)	use finish code	217
Premium Plated (per X base)	use finish code	751
Premium Plated (T & TT base, per column)	use finish code	404
Stainless Steel (per base)	use finish code	1,733

Base Options

Counter, Bar, & Alternate Height (per column)	CH, BH, AH	80
Super Level Glides (per base)	GSL	42
Locking Casters 2" Twin Wheel (qty. 4)	TWC2	68
Tilt-top - (standard cable release)	TMX/TMT	📞
Folding	FM	📞

Top Materials and Finishes

Any non-standard WCI Laminates (set-up charge)	use manufacturers finish code	173
Premium Laminates	PL	📞
Custom Wood Veneer	CWV	📞
Stain to Match (set-up charge)	STM	500

Top Options

3" Radius Corner (per corner) (Laminate self edge & Corian®)	CRL3	42
3" Wood Radius Corner (per corner) (not available in LWFL and WWFL)	CRW3	100
Custom Radius Corner	CRC	100
Custom Size	CS	📞
Custom Shape	CSH	📞
Custom Edge Thickness	CET	📞
Ganging Clips (1 set includes 2 male and 2 female clips)	GC	180

Grommets

2" Round Metal Grommet - Matte Black	GMBM	168
2" Round Metal Grommet - Satin Chrome	GMSC	168
2" Round Metal Grommet - Polished Chrome	GMPC	168
2" Round Plastic Grommet - Matte Black	GPMBM	54
Grommet location	use location code	n/c











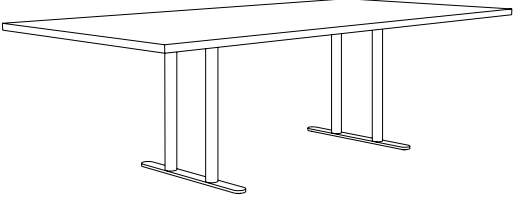







Power, Data, & Wire Management

Wire management	Pages 200-203
Power & data	Pages 236-237

📞 Call for pricing

415.621.6656

# DUNHILL – Dining & Multipurpose

	Laminate Surface				Wood Surface			
	Self Edge	Vinyl Edges	PVC Edges	Wood Edges Group A	Wood Edges Group B	Wood Edges Group A	Wood Edges Group B	Butcher Block
	 LLSE Self Edge	 LVFL Flat	 LPVC PVC	 LWFL Flat	 LWSQ Square	 WWFL Flat	 WWSQ Square	 BBFL Flat
		 LVBP Bumper		 LWTP Tapered Ply	 LWBN Bullnose	 WWTP Tapered Ply	 WWBN Bullnose	 BBBN Bullnose
				 LWFP Flat Ply	 LWPR Prism	 WWFP Flat Ply	 WWPR Prism	







## Complete Table List Pricing

	Top Size	Base Qty.	Base Style	Model #									
Rectangle 	42	72	2	TT	DUTT4272RE	2,692	2,692	2,804	3,377	4,057	3,499	4,216	-
	42	84	2	TT	DUTT4284RE	3,132	3,132	3,252	3,571	4,447	3,979	4,984	-
	42	96	2	TT	DUTT4296RE	3,293	3,293	3,425	3,781	4,835	4,222	5,059	-
	48	96	2	TT	DUTT4896RE	3,603	3,603	3,733	4,220	5,345	4,859	5,698	-
	48	120	2	TT	DUTT48120RE	3,969	3,969	4,135	4,636	5,734	5,384	6,223	-

## How to Order

Table Model Number							Options	
DUT	3672	RE	WWSQ	WMW	N/A	MBM	GMBM	E
Base Series	Top Size	Top Shape	Top Material Edge Profile	Top Finish	Edge Finish	Base Finish	Matte Black Grommet	Location "E"
A DUT3672REWWSQWMWMBM is a Dunhill series 36" x 72" rectangle table with two black powder coated T-bases and a wood veneer 1.25" thick top with a 1.25" square wood edge profile.					Edge finish applies when edge material is different from top material.		The code: GMBM specifies a matte black 2" diameter metal grommet.	The code: E specifies the location of the grommet.

Solid Surface

Corian® Group A	Corian® Group B
 C1FL Flat	 C2FL Flat
 C1BN Bullnose	 C2BN Bullnose
 C1PR Prism	 C2PR Prism

-	-
-	-
-	-
-	-
-	-
-	-

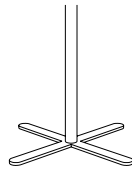

X, XH Base

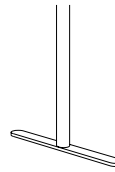

T Base

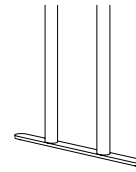

TT Base

Options

Base Finishes

Custom Powder Coat (set-up charge)	CPC	📞
Polished or Satin Chrome (per X base)	use finish code	434
Polished or Satin Chrome (T & TT base, per column)	use finish code	217
Premium Plated (per X base)	use finish code	751
Premium Plated (T & TT base, per column)	use finish code	404
Stainless Steel (per base)	use finish code	1,733

Base Options

Counter, Bar, & Alternate Height (per column)	CH, BH, AH	80
Super Level Glides (per base)	GSL	42
Locking Casters 2" Twin Wheel (qty. 4)	TWC2	68
Tilt-top - (standard cable release)	TMX/TMT	📞
Folding	FM	📞

Top Materials and Finishes

Any non-standard WCI Laminates (set-up charge)	use manufacturers finish code	173
Premium Laminates	PL	📞
Custom Wood Veneer	CWV	📞
Stain to Match (set-up charge)	STM	500

Top Options

3" Radius Corner (per corner) (Laminate self edge & Corian®)	CRL3	42
3" Wood Radius Corner (per corner) (not available in LWFL and WWFL)	CRW3	100
Custom Radius Corner	CRC	100
Custom Size	CS	📞
Custom Shape	CSH	📞
Custom Edge Thickness	CET	📞
Ganging Clips (1 set includes 2 male and 2 female clips)	GC	180

Grommets

2" Round Metal Grommet - Matte Black	GMBM	168
2" Round Metal Grommet - Satin Chrome	GMSC	168
2" Round Metal Grommet - Polished Chrome	GMPC	168
2" Round Plastic Grommet - Matte Black	GPMBM	54
Grommet location	use location code	n/c

Power, Data, & Wire Management

Wire management	Pages 200-203
Power & data	Pages 236-237

📞 Call for pricing

415.621.6656

# FLAT ROUND – Dining & Multipurpose

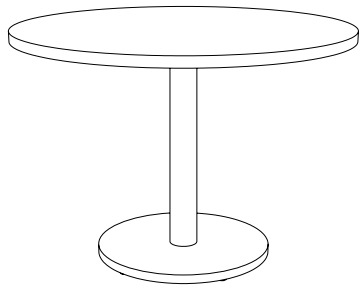

## Laminate Surface

## Wood Surface

Self Edge	Vinyl Edges	PVC Edges	Wood Edges Group A	Wood Edges Group B	Wood Edges Group A	Wood Edges Group B	Butcher Block
LLSE Self Edge	LVFL Flat	LPVC PVC	LWFL Flat	LWSQ Square	WWFL Flat	WWSQ Square	BBFL Flat
	LVBP Bumper		LWTP Tapered Ply	LWBN Bullnose	WWTP Tapered Ply	WWBN Bullnose	BBBN Bullnose
			LWFP Flat Ply	LWPR Prism	WWFP Flat Ply	WWPR Prism	

## Complete Table List Pricing

	Top Size	Base Qty.	Model #	1,056	1,056	1,143	1,422	1,717	1,439	1,844	1,696	
Round	24	1	FR24RD	1,056	1,056	1,143	1,422	1,717	1,439	1,844	1,696	
	30	1	FR30RD	1,163	1,163	1,271	1,620	1,936	1,741	2,088	2,127	
	36	1	FR36RD	1,538	1,538	1,664	2,076	2,442	2,121	2,626	2,900	
	42	1	FR42RD	1,715	1,715	1,856	2,278	2,730	2,442	2,950	3,820	
	48	1	FR48RD	1,895	1,895	2,053	2,522	3,041	2,716	3,301	4,302	
	54	1	FR54RD	2,286	2,286	2,470	3,096	4,167	3,338	4,542	-	
	60	1	FR60RD	2,595	2,595	2,793	3,305	4,311	3,935	4,706	-	
Oval	36	72	2	FR3672OV	2,545	2,545	2,634	2,998	3,388	3,301	3,680	-
	42	54	2	FR4254OV	2,505	2,505	2,553	2,911	3,484	3,175	3,589	-
	42	78	2	FR4278OV	3,486	3,486	3,560	3,897	4,282	4,147	4,579	-
	42	84	2	FR4284OV	3,584	3,584	3,680	3,985	4,425	4,241	4,737	-
	48	78	2	FR4878OV	4,038	4,038	4,139	4,433	4,870	4,702	5,191	-
	48	96	2	FR4896OV	4,346	4,346	4,444	4,694	5,169	5,328	5,883	-
RD Square	24	24	1	FR2424RS	1,059	1,059	1,156	1,422	1,717	1,439	1,844	1,819
	30	30	1	FR3030RS	1,163	1,163	1,281	1,619	1,936	1,741	2,088	2,289
	36	36	1	FR3636RS	1,538	1,538	1,656	2,057	2,442	2,121	2,626	3,106
	42	42	1	FR4242RS	1,693	1,693	1,826	2,278	2,731	2,442	2,950	4,142
	48	48	1	FR4848RS	2,095	2,095	2,251	2,718	3,237	2,912	3,497	4,876
Square	24	24	1	FR2424SQ	1,059	1,059	1,156	1,422	1,717	1,439	1,844	1,819
	30	30	1	FR3030SQ	1,163	1,163	1,281	1,619	1,936	1,741	2,088	2,289
	36	36	1	FR3636SQ	1,538	1,538	1,656	2,057	2,442	2,121	2,626	3,106
	42	42	1	FR4242SQ	1,693	1,693	1,826	2,278	2,731	2,442	2,950	4,142
	48	48	1	FR4848SQ	2,095	2,095	2,251	2,718	3,237	2,912	3,497	4,876

Continued on next page

## How to Order

### Table Model Number

### Options

FR Base Series    36 Top Size    RD Top Shape    WWSQ Top Material Edge Profile    WMW Top Finish    N/A Edge Finish    MBM Base Finish











GSL Super Level Glides

A FR36RDWWSQWMWMBM is a Flat Round series 36" round table with a black powder coat round base and a wood veneer 1.25" thick top with a 1.25" square wood edge profile.

Edge finish applies when edge material is different from top material.

The code: GSL specifies super level glides.

# Dining & Multipurpose – FLAT ROUND

Solid Surface		Quartz Surface	
Corian® Group A	Corian® Group B	Quartz Group A	Quartz Group B
 C1FL Flat	 C2FL Flat	 Q1FL Flat	 Q2FL Flat
 C1BN Bullnose	 C2BN Bullnose	 Q1BN Bullnose	 Q2BN Bullnose
 C1PR Prism	 C2PR Prism		

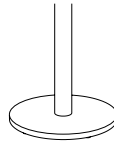

## Options

### Base Finishes

Custom Powder Coat (set-up charge)	CPC	📞
Polished or Satin Chrome (per base)	use finish code	289
Premium Plated (per base)	use finish code	578
Stainless Steel (per base)	use finish code	1,733

### Base Options

Counter, Bar, & Alternate Height (per column)	CH, BH, AH	80
Super Level Glides (per base)	GSL	42
Custom Top Plate Size	CTPS	📞
6" Column (black texture and powder coat)	COL6	235
6" Column (polished or satin chrome)	COLP6	300
6" Column (premium plated)	COLPP6	📞
6" Column (veneer)	COLV6	468

### Top Materials and Finishes

Any non-standard WCI Laminates (set-up charge)	use manufacturers finish code	173
Premium Laminates	PL	📞
Custom Wood Veneer	CWV	📞
Stain to Match (set-up charge)	STM	500

### Top Options

3" Radius Corner (per corner)	CRL3	42
(Laminate self edge & Corian®)		
3" Wood Radius Corner (per corner)	CRW3	100
(not available in LWFL and WWFL)		
Custom Size	CS	📞
Custom Radius Corner	CRC	100
Custom Shape	CSH	📞
Custom Edge Thickness	CET	📞

### Grommets

2" Round Metal Grommet - Matte Black	GMBM	167
2" Round Metal Grommet - Satin Chrome	GMSC	167
2" Round Metal Grommet - Polished Chrome	GMPC	167
2" Round Plastic Grommet - Matte Black	GPMBM	53
Grommet location	use location code	n/c









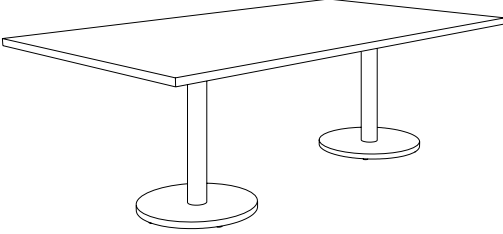









2,156	2,245	3,722	4,746
2,676	2,787	4,689	6,614
3,596	3,746	6,537	8,062
4,344	4,525	7,900	10,141
5,192	5,408	-	-
6,332	6,596	-	-
7,384	7,692	-	-
-	-	-	-
-	-	-	-
-	-	-	-
-	-	-	-
-	-	-	-
-	-	-	-
-	-	-	-
-	-	-	-
-	-	-	-
-	-	-	-
1,995	2,078	2,533	4,115
2,474	2,577	3,914	5,777
3,371	3,512	5,105	7,308
4,075	4,245	6,765	8,971
5,112	5,325	-	-

📞 Call for pricing

415.621.6656

# FLAT ROUND – Dining & Multipurpose



Laminate Surface				Wood Surface			
Self Edge	Vinyl Edges	PVC Edges	Wood Edges Group A	Wood Edges Group B	Wood Edges Group A	Wood Edges Group B	Butcher Block
 LLSE Self Edge	 LVFL Flat	 LPVC PVC	 LWFL Flat	 LWSQ Square	 WWFL Flat	 WWSQ Square	 BBFL Flat
	 LVBP Bumper		 LWTP Tapered Ply	 LWBN Bullnose	 WWTP Tapered Ply	 WWBN Bullnose	 BBBN Bullnose
			 LWFP Flat Ply	 LWPR Prism	 WWFP Flat Ply	 WWPR Prism	

## Complete Table List Pricing

	Top Size		Base Qty.	Model #								
Rectangle	24	30	1	FR2430RE	1,108	1,108	1,191	1,529	1,855	1,670	1,995	2,023
	24	36	1	FR2436RE	1,158	1,158	1,250	1,638	1,954	1,753	2,110	2,258
	24	42	1	FR2442RE	1,451	1,451	1,531	1,944	2,295	2,068	2,461	2,831
	24	48	1	FR2448RE	1,514	1,514	1,612	2,072	2,461	2,212	2,645	2,928
	24	60	2	FR2460RE	2,111	2,111	2,218	2,710	3,153	2,865	3,364	3,857
	24	72	2	FR2472RE	2,213	2,213	2,337	2,880	3,387	3,060	3,630	4,296
	24	84	2	FR2484RE	2,593	2,593	2,707	3,024	3,879	3,221	4,184	4,616
	24	96	2	FR2496RE	2,695	2,695	2,821	3,167	4,091	3,381	4,421	4,938
	30	36	1	FR3036RE	1,238	1,238	1,315	1,732	2,078	1,857	2,246	2,558
	30	42	1	FR3042RE	1,535	1,535	1,625	2,132	2,522	2,277	2,715	3,221
	30	48	1	FR3048RE	1,598	1,598	1,698	2,212	2,634	2,370	2,842	3,326
	30	60	2	FR3060RE	2,230	2,230	2,343	2,898	3,381	3,078	3,619	4,339
	30	72	2	FR3072RE	2,350	2,350	2,487	3,030	3,578	3,229	3,841	4,871
	30	84	2	FR3084RE	2,758	2,758	2,873	3,197	4,051	3,413	4,372	5,193
	30	96	2	FR3096RE	2,880	2,880	3,007	3,361	4,354	3,600	4,713	5,514
	36	42	1	FR3642RE	1,618	1,618	1,721	2,230	2,658	2,392	2,868	3,595
	36	48	1	FR3648RE	1,689	1,689	1,797	2,323	2,782	2,494	3,004	3,711
	36	60	2	FR3660RE	2,347	2,347	2,473	2,998	3,517	3,193	3,776	4,809
	36	72	2	FR3672RE	2,490	2,490	2,626	3,223	3,809	3,442	4,106	5,423
	36	84	2	FR3684RE	2,920	2,920	3,042	3,405	4,220	3,651	4,567	6,037
	36	96	2	FR3696RE	3,064	3,064	3,209	3,589	4,527	3,857	4,909	6,640
	42	72	2	FR4272RE	3,108	3,108	3,222	3,807	4,499	3,930	4,661	-
	42	84	2	FR4284RE	3,556	3,556	3,680	4,005	4,897	4,420	5,444	-
	42	96	2	FR4296RE	3,722	3,722	3,855	4,219	5,293	4,667	5,520	-
	48	96	2	FR4896RE	3,914	3,914	4,047	4,542	5,688	5,195	6,049	-
	48	120	2	FR48120RE	4,287	4,287	4,458	4,967	6,086	5,729	6,582	-

## How to Order

Table Model Number							Options	
<b>FR</b> Base Series	<b>4896</b> Top Size	<b>RA</b> Top Shape	<b>WWSQ</b> Top Material Edge Profile	<b>WMW</b> Top Finish	<b>N/A</b> Edge Finish	<b>MBM</b> Base Finish	<b>GMBM</b> Matte Black Grommet	<b>C</b> Location "C"
A FR4896RAWWSQWMWMBM is a Flat Round series 48" x 96" racetrack table with two black powder coat rounds bases and a wood veneer 1.25" thick top with a 1.25" square wood edge profile.					Edge finish applies when edge material is different from top material.		The code: GMBM specifies a matte black 2" diameter metal grommet.	The code: C specifies the location of the grommet.



# KONE – Dining & Multipurpose

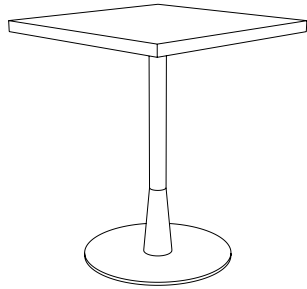

## Laminate Surface      Wood Surface

Self Edge	PVC Edges	Wood Edges Group A	Wood Edges Group A	Wood Edges Group B	Butcher Block
LLSE Self Edge	LPVC PVC	LWFL Flat	WWFL Flat	WWSQ Square	BBFL Flat
LFSE Facet Self Edge		LWTP Tapered Ply	WWTP Tapered Ply	WWBN Bullnose	BBBN Bullnose
		LWFP Flat Ply	WWFP Flat Ply	WWPR Prism	
			WVFC Facet	WWFC Facet	

## Complete Table List Pricing

	Top Size		Base Qty.	Model #						
<b>Round</b> 	24		1	KO24RD	1,751	1,833	2,098	2,116	2,503	2,361
	30		1	KO30RD	1,851	1,954	2,288	2,407	2,737	2,774
	36		1	KO36RD	2,258	2,380	2,773	2,816	3,300	3,563
	42		1	KO42RD	2,428	2,561	2,966	3,124	3,612	4,442
	48		1	KO48RD	3,102	3,253	3,702	3,887	4,448	5,405
<b>Oval</b> 	36	72	2	KO3672OV	3,912	3,998	4,347	4,636	4,999	-
<b>Square</b> 	24	24	1	KO2424SQ	1,751	1,844	2,098	2,116	2,503	2,479
	30	30	1	KO3030SQ	1,851	1,965	2,288	2,407	2,737	2,931
	36	36	1	KO3636SQ	2,258	2,372	2,756	2,816	3,300	3,759
<b>Rectangle</b> 	24	30	1	KO2430RE	1,799	1,877	2,201	2,337	2,647	2,675
	24	36	1	KO2436RE	2,119	2,208	2,579	2,690	3,031	3,173
	24	42	1	KO2442RE	2,175	2,251	2,649	2,766	3,142	3,499
	24	48	1	KO2448RE	2,233	2,328	2,768	2,903	3,317	3,590
	24	60	2	KO2460RE	3,499	3,600	4,070	4,219	4,696	5,168
	24	72	2	KO2472RE	3,595	3,713	4,233	4,405	4,952	5,588

Continued on next page

## How to Order

Table Model Number							Options	
<b>KO</b> Base Series	<b>36</b> Top Size	<b>RD</b> Top Shape	<b>WWFC</b> Top Material Edge Profile	<b>WMW</b> Top Finish	<b>N/A</b> Edge Finish	<b>MBM</b> Base Finish	<b>WMW</b> Wood Column Finish	<b>AH</b> Alternate Height Base
A KO36RDWWFCWMWMBMWMW is a Kone series 36" round table with a black powder coat round base and a wood veneer 1.25" thick top with a 1.25" facet wood edge profile.					Edge finish applies when edge material is different from top material.		The code: AH specifies alternate height base.	

Solid Surface

Quartz Surface

Corian®  
Group A

Corian®  
Group B

Quartz  
Group A

Quartz  
Group B



C1FL  
Flat



C2FL  
Flat



Q1FL  
Flat



Q2FL  
Flat



C1BN  
Bullnose



C2BN  
Bullnose



Q1BN  
Bullnose



Q2BN  
Bullnose



C1PR  
Prism



C2PR  
Prism

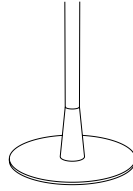

Options

Base Finishes

Custom Powder Coat (set-up charge)	CPC	693
Polished or Satin Chrome (per base)	use finish code	1,502
Premium Plated (per base)	use finish code	1,733
Stainless Steel (per base)	use finish code	

Base Options

Alternate Height Base (per column)(29.25 or lower)	AH	80
Nylon Octagon Glides (per base)	GNO	42
Custom Top Plate Size	CTPS	
Base sizes may vary with quartz tops		

Top Materials and Finishes

Any non-standard WCI Laminates (set-up charge)	use manufacturers finish code	173
Premium Laminates	PL	
Custom Wood Veneer	CWV	
Stain to Match (set-up charge)	STM	500

Top Options

3" Radius Corner (per corner) (Laminate self edge & Corian®)	CRL3	42
3" Wood Radius Corner (per corner) (not available in LWFL and WWFL)	CRW3	99
Custom Radius Corner	CRC	99
Custom Size	CS	
Custom Shape	CSH	
Custom Edge Thickness	CET	

Call for pricing

415.621.6656

2,922	3,044	4,315	5,269
4,380	4,562	5,256	7,093
4,380	4,562	7,103	8,547
5,110	5,323	8,433	10,574
6,494	6,765	-	-
-	-	-	-

2,764	2,879	3,154	4,655
3,233	3,367	4,752	6,514
4,161	4,334	5,707	7,811

2,979	3,103	3,134	5,142
3,494	3,640	3,645	5,865
3,700	3,854	4,007	6,191
3,912	4,076	-	-
5,658	5,893	-	-
6,104	6,358	-	-

# KONE – Dining & Multipurpose

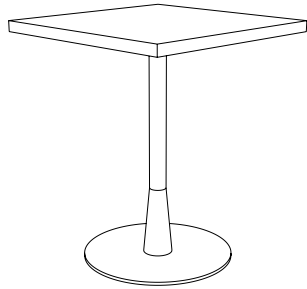

Laminate Surface			Wood Surface			
Self Edge	PVC Edges	Wood Edges Group A	Wood Edges Group A	Wood Edges Group B	Butcher Block	
LLSE Self Edge	LPVC PVC	LWFL Flat	WWFL Flat	WWSQ Square	BBFL Flat	
LFSE Facet Self Edge		LWTP Tapered Ply	WWTP Tapered Ply	WWBN Bullnose	BBBN Bullnose	
		LWFP Flat Ply	WWFP Flat Ply	WWPR Prism		
			WWFC Facet	WWFC Facet		

## Complete Table List Pricing











	Top Size		Base Qty.	Model #						
Rectangle 	30	36	1	KO3036RE	2,197	2,271	2,668	2,789	3,162	3,458
	30	42	1	KO3042RE	2,255	2,343	2,829	2,965	3,386	3,869
	30	48	1	KO3048RE	2,818	2,913	3,406	3,557	4,008	4,472
	30	60	2	KO3060RE	3,613	3,720	4,249	4,422	4,941	5,630
	30	72	2	KO3072RE	3,727	3,856	4,377	4,568	5,154	6,140
	36	42	1	KO3642RE	2,333	2,433	2,921	3,077	3,531	4,228
	36	48	1	KO3648RE	2,903	3,008	3,512	3,676	4,164	4,841
	36	60	2	KO3660RE	4,268	4,390	4,892	5,080	5,638	6,624
	36	72	2	KO3672RE	4,406	4,536	5,108	5,317	5,952	7,215

## How to Order

Table Model Number								Options
<b>KO</b> Base Series	<b>36</b> Top Size	<b>RD</b> Top Shape	<b>WWFC</b> Top Material Edge Profile	<b>WMW</b> Top Finish	<b>N/A</b> Edge Finish	<b>MBM</b> Base Finish	<b>WMW</b> Wood Column Finish	<b>AH</b> Alternate Height Base
A KO36RDWWFCWMWMBMWMW is a Kone series 36" round table with a black powder coat round base and a wood veneer 1.25" thick top with a 1.25" facet wood edge profile.					Edge finish applies when edge material is different from top material.			The code: AH specifies alternate height base.

Solid Surface

Quartz Surface

Corian® Group A	Corian® Group B	Quartz Group A	Quartz Group B
 C1FL Flat	 C2FL Flat	 Q1FL Flat	 Q2FL Flat
 C1BN Bullnose	 C2BN Bullnose	 Q1BN Bullnose	 Q2BN Bullnose
 C1PR Prism	 C2PR Prism		

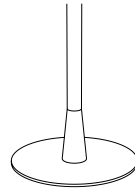

Options

Base Finishes

Custom Powder Coat (set-up charge)	CPC	693
Polished or Satin Chrome (per base)	use finish code	1,502
Premium Plated (per base)	use finish code	1,733
Stainless Steel (per base)	use finish code	

Base Options

Alternate Height Base (per column)(29.25 or lower)	AH	80
Nylon Octagon Glides (per base)	GNO	42
Custom Top Plate Size	CTPS	
Base sizes may vary with quartz tops		

Top Materials and Finishes

Any non-standard WCI Laminates (set-up charge)	use manufacturers finish code	173
Premium Laminates	PL	
Custom Wood Veneer	CWV	
Stain to Match (set-up charge)	STM	500

Top Options





3" Radius Corner (per corner) (Laminate self edge & Corian®)	CRL3	42
3" Wood Radius Corner (per corner) (not available in LWFL and WWFL)	CRW3	99
Custom Radius Corner	CRC	99
Custom Size	CS	
Custom Shape	CSH	
Custom Edge Thickness	CET	

3,796	3,955	4,303	6,677
4,055	4,224	4,542	6,838
4,895	5,099	-	-
6,160	6,417	-	-
6,694	6,973	-	-
4,763	4,961	5,680	8,345
5,931	6,178	-	-
7,311	7,616	-	-
7,920	8,250	-	-

Call for pricing

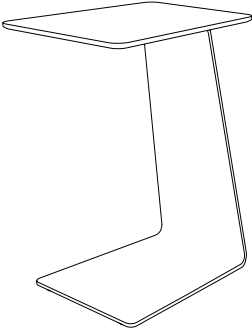
415.621.6656

# MOVE – Multipurpose

	Laminate	Wood	Solid Surface	
	Laminate	Veneer	Corian® Group A	Corian® Group B
	 LMOV Ply	 WMOV Wood	 C1MOV	 C2MOV

## Complete Table List Pricing

	Top Size		Table Height		Model #				
	18	13	15	25					
Trapezoid	18	13	15	25	MOV	1,260	1,392	1,490	1,552
									

## How to Order

### Table Model Number

<b>MOV</b> Table Series	<b>WMOV</b> Top Material	<b>WNM</b> Top Finish	<b>MBM</b> Base Finish
----------------------------	-----------------------------	--------------------------	---------------------------

A MOVWMOVWNMBM is a Move table with a matte black powder coat base and a wood veneer top.

The code: WNM specifies a natural maple top.

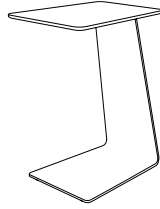

**Options**

**Base Finishes**

Custom Powder Coat (set-up charge)	CPC	📞
Satin Chrome (per base)	use finish code	523
Premium Plated (per base)*	use finish code	1,502

\*Premium plated polished not available on Move tables.

**Top Materials and Finishes**

Any non-standard WCI Laminates (set-up charge)	use manufacturers finish code	173
Premium Laminates	PL	📞
Custom Wood Veneer	CWV	📞
Stain to Match (set-up charge)	STM	500

**Top Options**

Handle**	HAN	104
Cup holder Left	CHL	104
Cup Holder Right	CHR	104
Bag Hook Left	BHL	75
Bag Hook Right	BHR	75

\*\*Handle available for Corian®.



📞 Call for pricing

415.621.6656

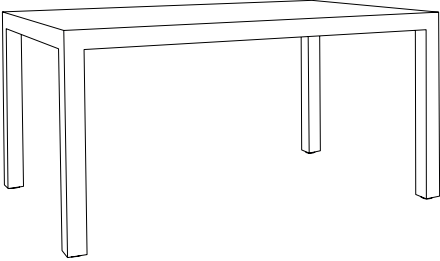
# PARSONS – Dining & Multipurpose

	Laminate	Wood
	Laminate LAM Laminate	Veneer VEN Wood Veneer

## Complete Table List Pricing

	Top Size		Base Qty.	Model #		
Square 	36	36	1	PA3636SQ	3,410	4,641
	42	42	1	PA4242SQ	3,777	5,180
	48	48	1	PA4848SQ	4,163	5,929
Rectangle 	24	60	1	PA2460RE	3,568	4,900
	24	72	1	PA2472RE	3,862	5,259
	24	84	1	PA2484RE	4,505	6,134
	24	96	1	PA2496RE	5,151	7,011
	24	120	1	PA24120RE	6,438	8,763
	30	60	1	PA3060RE	3,824	5,234
	30	72	1	PA3072RE	4,170	5,799
	30	84	1	PA3084RE	4,866	6,764
	30	96	1	PA3096RE	5,560	7,731
	30	120	1	PA30120RE	6,950	9,664
	36	60	1	PA3660RE	4,107	5,730
	36	72	1	PA3672RE	4,485	6,228
	36	84	1	PA3684RE	5,232	7,265
	36	96	1	PA3696RE	5,981	8,304
	36	120	1	PA36120RE	7,476	10,380
	42	60	1	PA4260RE	4,790	6,686
	42	72	1	PA4272RE	5,749	8,023
	42	84	1	PA4284RE	6,707	9,360
	42	96	1	PA4296RE	7,664	10,697
	42	120	1	PA42120RE	9,582	13,372

## How to Order

Table Model Number					Options
PA Base Series	3636 Top Size	SQ Top Shape	VEN Material	WNW Top, edge and leg finish	PAH1 Alternate Height Base - Below 29"
A PA3636SQVENWNW is a Parsons series 36" x 36" square table with wood veneer top, edge and legs.				The code: WNW specifies a natural walnut top.	The code: PAH1 specifies alternate height base below 29".

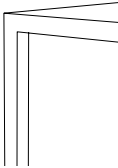

**Options**

<b>Base Options</b>		
Counter Height	CH	pages 102-103
Bar Height	BH	pages 102-103
Alternate Height	AH	1,091
<b>Top Materials and Finishes</b>		
Any non-standard WCI Laminates (set-up charge)	use manufacturers finish code	173
Premium Laminates	PL	📞
Custom Wood Veneer	CWV	📞
Stain to Match (set-up charge)	STM	500
<b>Top Options</b>		
Custom Size	CS	📞
Custom Shape	CSH	📞

📞 Call for pricing



415.621.6656

# PARSONS – Counter & Bar Height - Dining & Multipurpose

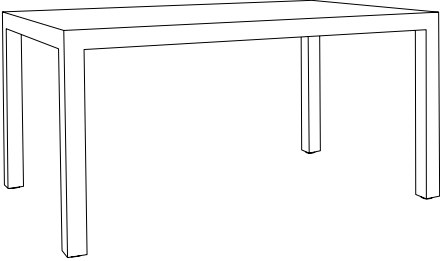
	Laminate	Wood
	LAM Laminate	VEN Wood Veneer



## Complete Table List Pricing

	Top Size		Base Qty.	Model #		
Square 	36	36	1	PA3636SQ	4,356	5,555
	42	42	1	PA4242SQ	4,714	6,079
	48	48	1	PA4848SQ	5,090	6,810
Rectangle 	24	60	1	PA2460RE	4,509	5,807
	24	72	1	PA2472RE	4,796	6,156
	24	84	1	PA2484RE	5,423	7,009
	24	96	1	PA2496RE	6,051	7,862
	24	120	1	PA24120RE	7,305	9,570
	30	60	1	PA3060RE	4,759	6,133
	30	72	1	PA3072RE	5,097	6,682
	30	84	1	PA3084RE	5,774	7,623
	30	96	1	PA3096RE	6,451	8,564
	30	120	1	PA30120RE	7,803	10,446
	36	60	1	PA3660RE	5,034	6,616
	36	72	1	PA3672RE	5,404	7,100
	36	84	1	PA3684RE	6,131	8,110
	36	96	1	PA3696RE	6,860	9,121
	36	120	1	PA36120RE	8,316	11,145
	42	60	1	PA4260RE	5,701	7,545
	42	72	1	PA4272RE	6,633	8,848
	42	84	1	PA4284RE	7,566	10,151
	42	96	1	PA4296RE	8,499	11,454
	42	120	1	PA42120RE	10,366	14,058

## How to Order

Table Model Number					Options
PA Base Series	3636 Top Size	SQ Top Shape	VEN Material	WNW Top, edge and leg finish	PAH1 Alternate Height Base - Below 29"
A PA3636SQVENWNW is a Parsons series 36" x 36" square table with wood veneer top, edge and legs.				The code: WNW specifies a natural walnut top.	The code: PAH1 specifies alternate height base below 29".

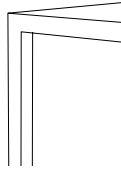

---

**Options**

**Top Materials and Finishes**

Any non-standard WCI Laminates (set-up charge)	use manufacturers finish code	173
Premium Laminates	PL	
Custom Wood Veneer	CWV	
Stain to Match (set-up charge)	STM	500

**Top Options**











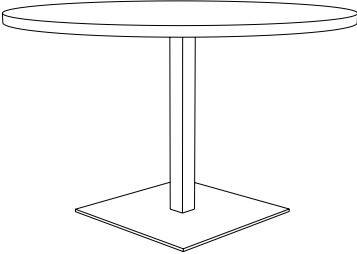







Custom Size	CS	
Custom Shape	CSH	

---





Call for pricing

415.621.6656

# PLATFORM – Dining & Multipurpose

	Laminate Surface				Wood Surface			
	Self Edge	Vinyl Edges	PVC Edges	Wood Edges Group A	Wood Edges Group B	Wood Edges Group A	Wood Edges Group B	Butcher Block
	 LLSE Self Edge	 LVFL Flat	 LPVC PVC	 LWFL Flat	 LWSQ Square	 WWFL Flat	 WWSQ Square	 BBFL Flat
		 LVBP Bumper		 LWTP Tapered Ply	 LWBN Bullnose	 WWTP Tapered Ply	 WWBN Bullnose	 BBBN Bullnose
				 LWFP Flat Ply	 LWPR Prism	 WWFP Flat Ply	 WWPR Prism	











## Complete Table List Pricing

	Top Size		Base Qty.	Model #								
Round 	30		1	PL30RD	1,266	1,266	1,372	1,714	2,024	1,833	2,175	2,213
	36		1	PL36RD	1,712	1,712	1,837	2,241	2,599	2,285	2,780	3,050
	48		1	PL48RD	2,304	2,304	2,459	2,918	3,427	3,109	3,683	4,665
	54		1	PL54RD	2,495	2,495	2,675	3,290	4,342	3,527	4,709	-
	60		1	PL60RD	2,798	2,798	2,993	3,495	4,482	4,114	4,871	-
RD Square 	24	24	1	PL2424RS	1,163	1,163	1,258	1,519	1,811	1,537	1,934	1,910
	30	30	1	PL3030RS	1,266	1,266	1,382	1,714	2,024	1,833	2,175	2,372
	36	36	1	PL3636RS	1,712	1,712	1,828	2,222	2,599	2,285	2,780	3,252
	42	42	1	PL4242RS	1,864	1,864	1,996	2,439	2,883	2,599	3,098	4,270
	48	48	1	PL4848RS	2,306	2,306	2,459	2,919	3,427	3,110	3,684	5,037
Square 	24	24	1	PL2424SQ	1,163	1,163	1,258	1,519	1,811	1,537	1,934	1,910
	30	30	1	PL3030SQ	1,266	1,266	1,382	1,714	2,024	1,833	2,175	2,372
	36	36	1	PL3636SQ	1,712	1,712	1,828	2,222	2,599	2,285	2,780	3,252
	42	42	1	PL4242SQ	1,864	1,864	1,996	2,439	2,883	2,599	3,098	4,270
	48	48	1	PL4848SQ	2,306	2,306	2,459	2,919	3,427	3,110	3,684	5,037
Rectangle 	24	30	1	PL2430RE	1,213	1,213	1,294	1,625	1,945	1,763	2,083	2,111
	24	36	1	PL2436RE	1,571	1,571	1,661	2,041	2,352	2,155	2,505	2,650
	24	42	1	PL2442RE	1,626	1,626	1,705	2,112	2,456	2,232	2,618	2,982
	24	48	1	PL2448RE	1,688	1,688	1,784	2,236	2,618	2,374	2,799	3,077
	24	60	2	PL2460RE	2,323	2,323	2,426	2,909	3,344	3,061	3,551	4,036
	24	72	2	PL2472RE	2,421	2,421	2,542	3,077	3,574	3,253	3,812	4,466
	24	84	2	PL2484RE	2,795	2,795	2,907	3,217	4,057	3,412	4,358	4,782
	24	96	2	PL2496RE	2,894	2,894	3,019	3,358	4,265	3,568	4,590	5,097

Continued on next page

## How to Order

Table Model Number							Options
PL Base Series	36 Top Size	RD Top Shape	WWSQ Top Material Edge Profile	MMW Top Finish	N/A Edge Finish	MBM Base Finish	AH Alternate Height Base
A PL36RDWWSQMMWMBM is a Platform series 36" round table with a black powder coat square base and a wood veneer 1.25" thick top with a 1.25" square wood edge profile.						Edge finish applies when edge material is different from top material.	The code: AH specifies alternate height base.

Solid Surface		Quartz Surface	
Corian® Group A	Corian® Group B	Quartz Group A	Quartz Group B
 C1FL Flat	 C2FL Flat	 Q1FL Flat	 Q2FL Flat
 C1BN Bullnose	 C2BN Bullnose	 Q1BN Bullnose	 Q2BN Bullnose
 C1PR Prism	 C2PR Prism		

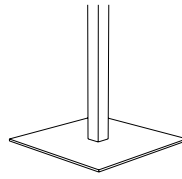

Single Column Base

### Options

#### Base Finishes

Custom Powder Coat (set-up charge)	CPC	693
Polished or Satin Chrome (per base)	use finish code	1,502
Premium Plated (per base)	use finish code	1,733
Stainless Steel (per base)	use finish code	1,733

#### Base Options

Counter, Bar, & Alternate Height (per column)	CH, BH, AH	80
Nylon Octagon Glides (per base)	GNO	42
Custom Top Plate Size	CTPS	693
6" Column (black texture and powder coat)	COL6	235
6" Column (polished or satin chrome)	COLP6	300
6" Column (premium plated)	COLPP6	693
6" Column (veneer)	COLV6	468
Base sizes may vary with quartz tops		

#### Top Materials and Finishes

Any non-standard WCI Laminates (set-up charge)	use manufacturers finish code	173
Premium Laminates	PL	693
Custom Wood Veneer	CWV	693
Stain to Match (set-up charge)	STM	500

#### Top Options

3" Radius Corner (per corner) (Laminate self edge & Corian®)	CRL3	42
3" Wood Radius Corner (per corner) (not available in LWFL and WWFL)	CRW3	100
Custom Size	CS	693
Custom Radius Corner	CRC	100
Custom Shape	CSH	693
Custom Edge Thickness	CET	693

#### Grommets

2" Round Metal Grommet - Matte Black	GMBM	167
2" Round Metal Grommet - Satin Chrome	GMSC	167
2" Round Metal Grommet - Polished Chrome	GMPC	167
2" Round Plastic Grommet - Matte Black	GPMBM	53
Grommet location	use location code	n/c

2,814	2,932	-	-
3,821	3,981	-	-
5,684	5,921	-	-
6,609	6,885	-	-
7,661	7,981	-	-
-	-	-	-
-	-	-	-
-	-	-	-
-	-	-	-
-	-	-	-
2,133	2,222	2,649	4,224
2,612	2,721	4,028	5,886
3,596	3,746	5,292	7,485
4,299	4,478	6,952	9,147
5,390	5,614	-	-
2,354	2,452	2,629	4,721
2,912	3,033	3,179	5,490
3,124	3,255	3,551	5,821
3,341	3,480	-	-
4,398	4,582	-	-
4,854	5,056	-	-
-	-	-	-
-	-	-	-

Call for pricing

415.621.6656

# PLATFORM – Dining & Multipurpose











Laminate Surface						Wood Surface					
Self Edge	Vinyl Edges	PVC Edges	Wood Edges Group A	Wood Edges Group B	Wood Edges Group A	Wood Edges Group B	Butcher Block				
LLSE Self Edge	LVFL Flat	LPVC PVC	LWFL Flat	LWSQ Square	WWFL Flat	WWSQ Square	BBFL Flat				
	LVBP Bumper		LWTP Tapered Ply	LWBN Bullnose	WWTP Tapered Ply	WWBN Bullnose	BBBN Bullnose				
			LWFP Flat Ply	LWPR Prism	WWFP Flat Ply	WWPR Prism					

## Complete Table List Pricing

	Top Size	Base Qty.	Model #								
Rectangle	30 36	1	PL3036RE	1,648	1,648	1,725	2,134	2,473	2,257	2,639	2,944
	30 42	1	PL3042RE	1,710	1,710	1,799	2,295	2,678	2,438	2,868	3,364
	30 48	1	PL3048RE	2,012	2,012	2,109	2,614	3,028	2,770	3,234	3,708
	30 60	2	PL3060RE	2,439	2,439	2,548	3,094	3,568	3,271	3,802	4,508
	30 72	2	PL3072RE	2,557	2,557	2,690	3,223	3,762	3,419	4,019	5,032
	30 84	2	PL3084RE	2,956	2,956	3,069	3,387	4,226	3,600	4,541	5,347
	30 96	2	PL3096RE	3,077	3,077	3,200	3,550	4,523	3,784	4,876	5,662
	36 42	1	PL3642RE	1,790	1,790	1,891	2,391	2,812	2,551	3,018	3,733
	36 48	1	PL3648RE	2,102	2,102	2,207	2,724	3,174	2,890	3,393	4,086
	36 60	2	PL3660RE	3,171	3,171	3,294	3,810	4,320	4,001	4,574	5,587
	36 72	2	PL3672RE	3,312	3,312	3,445	4,031	4,606	4,246	4,897	6,192
	36 84	2	PL3684RE	3,733	3,733	3,853	4,210	5,010	4,450	5,350	6,793
	36 96	2	PL3696RE	3,874	3,874	4,017	4,391	5,310	4,653	5,686	7,386
	42 72	2	PL4272RE	3,938	3,938	4,050	4,624	5,303	4,744	5,462	-
42 84	2	PL4284RE	4,377	4,377	4,498	4,817	5,693	5,225	6,230	-	
42 96	2	PL4296RE	4,539	4,539	4,671	5,028	6,081	5,468	6,305	-	
48 96	2	PL4896RE	4,729	4,729	4,859	5,346	6,470	5,985	6,824	-	
48 120	2	PL48120RE	5,094	5,094	5,262	5,762	6,861	6,510	7,349	-	

## How to Order

Table Model Number							Options	
PL Base Series	3636 Top Size	SQ Top Shape	WWSQ Top Material Edge Profile	WMW Top Finish	N/A Edge Finish	MBM Base Finish	GMBM Matte Black Grommet	E Location "E"
A PL3636SQWWSQWMWMBM is a Platform series 36" x 36" square table with a black powder coat square base and a wood veneer 1.25" thick top with a 1.25" square wood edge profile.						Edge finish applies when edge material is different from top material.	The code: GMBM specifies a matte black 2" diameter metal grommet.	The code: E specifies the location of the grommet.

Solid Surface		Quartz Surface	
Corian® Group A	Corian® Group B	Quartz Group A	Quartz Group B
 C1FL Flat	 C2FL Flat	 Q1FL Flat	 Q2FL Flat
 C1BN Bullnose	 C2BN Bullnose	 Q1BN Bullnose	 Q2BN Bullnose
 C1PR Prism	 C2PR Prism		

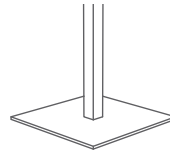

Single Column Base

### Options

#### Base Finishes

Custom Powder Coat (set-up charge)	CPC	693
Polished or Satin Chrome (per base)	use finish code	1,502
Premium Plated (per base)	use finish code	1,733
Stainless Steel (per base)	use finish code	1,733

#### Base Options

Counter, Bar, & Alternate Height (per column)	CH, BH, AH	80
Nylon Octagon Glides (per base)	GNO	42
Custom Top Plate Size	CTPS	693
6" Column (black texture and powder coat)	COL6	235
6" Column (polished or satin chrome)	COLP6	300
6" Column (premium plated)	COLPP6	693
6" Column (veneer)	COLV6	468
Base sizes may vary with quartz tops		

#### Top Materials and Finishes

Any non-standard WCI Laminates (set-up charge)	use manufacturers finish code	173
Premium Laminates	PL	693
Custom Wood Veneer	CWV	693
Stain to Match (set-up charge)	STM	500

#### Top Options

3" Radius Corner (per corner) (Laminate self edge & Corian®)	CRL3	42
3" Wood Radius Corner (per corner) (not available in LWFL and WWFL)	CRW3	100
Custom Size	CS	693
Custom Radius Corner	CRC	100
Custom Shape	CSH	693
Custom Edge Thickness	CET	693

#### Grommets

2" Round Metal Grommet - Matte Black	GMBM	167
2" Round Metal Grommet - Satin Chrome	GMSC	167
2" Round Metal Grommet - Polished Chrome	GMPC	167
2" Round Plastic Grommet - Matte Black	GPMBM	53
Grommet location	use location code	n/c

3,223	3,358	3,853	6,321
3,487	3,633	4,099	6,487
4,044	4,213	-	-
4,912	5,116	-	-
5,458	5,686	-	-
-	-	-	-
-	-	-	-
4,213	4,389	4,791	7,584
5,106	5,319	-	-
6,155	6,412	-	-
6,781	7,063	-	-
-	-	-	-
-	-	-	-
-	-	-	-
-	-	-	-
-	-	-	-
-	-	-	-
-	-	-	-

Call for pricing

415.621.6656

# PLATFORM DOUBLE – Dining & Multipurpose

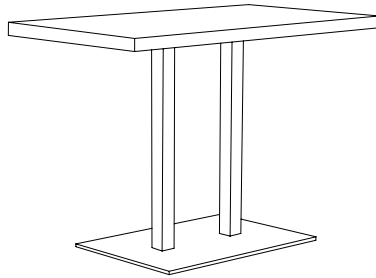

## Laminate Surface

## Wood Surface

Self Edge	Vinyl Edges	PVC Edges	Wood Edges Group A	Wood Edges Group B	Wood Edges Group A	Wood Edges Group B	Butcher Block
LLSE Self Edge	LVFL Flat	LPVC PVC	LWFL Flat	LWSQ Square	WWFL Flat	WWSQ Square	BBFL Flat
	LVBP Bumper		LWTP Tapered Ply	LWBN Bullnose	WWTP Tapered Ply	WWBN Bullnose	BBBN Bullnose
			LWFP Flat Ply	LWPR Prism	WWFP Flat Ply	WWPR Prism	

## Complete Table List Pricing

	Top Size		Base Qty.	Model #								
Rectangle	24	42	1	PLD2442RE	1,997	1,997	2,075	2,482	2,826	2,603	2,989	3,353
	24	48	1	PLD2448RE	2,058	2,058	2,155	2,606	2,989	2,743	3,170	3,448
	30	42	1	PLD3042RE	2,079	2,079	2,168	2,666	3,048	2,807	3,238	3,735
	30	48	1	PLD3048RE	2,142	2,142	2,239	2,743	3,159	2,899	3,363	3,837
	36	42	1	PLD3642RE	2,161	2,161	2,262	2,762	3,183	2,921	3,388	4,102
	36	48	1	PLD3648RE	2,231	2,231	2,337	2,854	3,304	3,021	3,522	4,216

## How to Order

### Table Model Number

<b>PLD</b> Base Series	<b>4272</b> Top Size	<b>RE</b> Top Shape	<b>WWSQ</b> Top Material Edge Profile	<b>WMW</b> Top Finish	<b>N/A</b> Edge Finish	<b>MBM</b> Base Finish
---------------------------	-------------------------	------------------------	---	--------------------------	---------------------------	---------------------------

### Options

<b>GMBM</b> Matte Black Grommet	<b>E</b> Location "E"
---------------------------------------	--------------------------











A PLD3648REWWSQWMWMBM is a Platform Double series 36" x 48" rectangle table with a black powder coat square base and a wood veneer 1.25" thick top with a 1.25" square wood edge profile.

Edge finish applies when edge material is different from top material.

The code: GMBM specifies a matte black 2" diameter metal grommet.

The code: E specifies the location of the grommet.

# Dining & Multipurpose – PLATFORM DOUBLE

Solid Surface		Quartz Surface	
Corian® Group A	Corian® Group B	Quartz Group A	Quartz Group B
 C1FL Flat	 C2FL Flat	 Q1FL Flat	 Q2FL Flat
 C1BN Bullnose	 C2BN Bullnose	 Q1BN Bullnose	 Q2BN Bullnose
 C1PR Prism	 C2PR Prism		

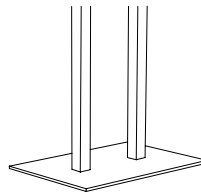

Double Column Base

## Options

### Base Finishes

Custom Powder Coat (set-up charge)	CPC	📞
Polished or Satin Chrome (per base)	use finish code	809
Premium Plated (per base)	use finish code	1,617
Stainless Steel (per base)	use finish code	1,733

### Base Options

Counter, Bar, & Alternate Height (per column)	CH, BH, AH	80
Nylon Octagon Glides (per base)	GNO	42
Custom Top Plate Size	CTPS	📞
6" Column (black texture and powder coat)	COL6	235
6" Column (polished or satin chrome)	COLP6	300
6" Column (premium plated)	COLPP6	📞
6" Column (veneer)	COLV6	468
Base sizes may vary with quartz tops		

### Top Materials and Finishes

Any non-standard WCI Laminates (set-up charge)	use manufacturers finish code	173
Premium Laminates	PL	📞
Custom Wood Veneer	CWV	📞
Stain to Match (set-up charge)	STM	500

### Top Options

3" Radius Corner (per corner) (Laminate self edge & Corian®)	CRL3	42
3" Wood Radius Corner (per corner) (not available in LWFL and WWFL)	CRW3	100
Custom Size	CS	📞
Custom Radius Corner	CRC	100
Custom Shape	CSH	📞
Custom Edge Thickness	CET	📞

### Grommets











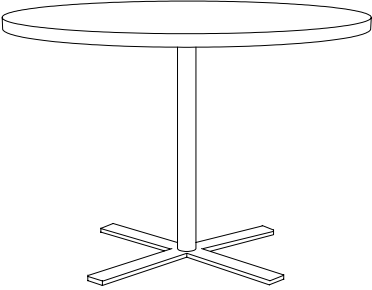







2" Round Metal Grommet - Matte Black	GMBM	167
2" Round Metal Grommet - Satin Chrome	GMSC	167
2" Round Metal Grommet - Polished Chrome	GMPC	167
2" Round Plastic Grommet - Matte Black	GPMBM	53
Grommet location	use location code	n/c

3,536	3,684	3,894	6,144
3,753	3,909	-	-
3,898	4,060	4,442	6,810
4,190	4,364	-	-
4,624	4,817	5,134	7,907
5,250	5,468	-	-



📞 Call for pricing

415.621.6656

# PLUS – Dining & Multipurpose

	Laminate Surface					Wood Surface						
	Self Edge	Vinyl Edges	PVC Edges	Wood Edges Group A	Wood Edges Group B	Wood Edges Group A	Wood Edges Group B	Butcher Block				
	 LLSE Self Edge	 LVFL Flat	 LPVC PVC	 LWFL Flat	 LWSQ Square	 WWFL Flat	 WWSQ Square	 BBFL Flat				
		 LVBP Bumper		 LWTP Tapered Ply	 LWBN Bullnose	 WWTP Tapered Ply	 WWBN Bullnose	 BBBN Bullnose				
				 LWFP Flat Ply	 LWPR Prism	 WWFP Flat Ply	 WWPR Prism					

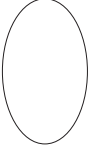
## Complete Table List Pricing







	Top Size		Base Qty.	Base Style	Model #								
<b>Round</b> 	24		1	X	PUX24RD	1,230	1,230	1,315	1,588	1,878	1,605	2,003	1,858
	30		1	X	PUX30RD	1,465	1,465	1,569	1,913	2,223	2,031	2,374	2,412
	36		1	X	PUX36RD	1,729	1,729	1,852	2,257	2,616	2,301	2,797	3,066
	42		1	X	PUX42RD	1,902	1,902	2,041	2,456	2,899	2,616	3,115	3,969
	48		1	X	PUX48RD	2,207	2,207	2,364	2,823	3,332	3,014	3,588	4,570
	54		1	XH	PUXH54RD	2,522	2,522	2,703	3,317	4,369	3,554	4,737	-
	60		1	XH	PUXH60RD	2,825	2,825	3,020	3,522	4,510	4,141	4,898	-
<b>Oval</b> 	36	72	2	T	PUT3672OV	2,382	2,382	2,469	2,826	3,209	3,123	3,495	-
	42	54	2	T	PUT4254OV	2,342	2,342	2,389	2,741	3,303	3,000	3,407	-
	42	78	2	T	PUT4278OV	2,844	2,844	2,915	3,248	3,626	3,493	3,916	-
	42	84	2	T	PUT4284OV	2,940	2,940	3,033	3,334	3,765	3,584	4,072	-
	48	78	2	TT	PUTT4878OV	3,218	3,218	3,318	3,607	4,036	3,871	4,350	-
	48	96	2	TT	PUTT4896OV	3,521	3,521	3,617	3,862	4,329	4,485	5,030	-
<b>RD Square</b> 	24	24	1	X	PUX2424RS	1,232	1,232	1,327	1,588	1,879	1,605	2,003	1,978
	30	30	1	X	PUX3030RS	1,464	1,464	1,580	1,913	2,223	2,031	2,372	2,571
	36	36	1	X	PUX3636RS	1,729	1,729	1,845	2,238	2,616	2,301	2,797	3,268
	42	42	1	X	PUX4242RS	2,009	2,009	2,141	2,584	3,028	2,744	3,243	4,415
	48	48	1	X	PUX4848RS	2,211	2,211	2,364	2,823	3,332	3,014	3,588	4,942
<b>Square</b> 	24	24	1	X	PUX2424SQ	1,232	1,232	1,327	1,588	1,879	1,605	2,003	1,978
	30	30	1	X	PUX3030SQ	1,464	1,464	1,580	1,913	2,223	2,031	2,372	2,571
	36	36	1	X	PUX3636SQ	1,729	1,729	1,845	2,238	2,616	2,301	2,797	3,268
	42	42	1	X	PUX4242SQ	2,009	2,009	2,141	2,584	3,028	2,744	3,243	4,415
	48	48	1	X	PUX4848SQ	2,211	2,211	2,364	2,823	3,332	3,014	3,588	4,942

Continued on next page

## How to Order

Table Model Number							Options
<b>PUX</b> Base Series	<b>36</b> Top Size	<b>RD</b> Top Shape	<b>WWSQ</b> Top Material Edge Profile	<b>WMW</b> Top Finish	<b>N/A</b> Edge Finish	<b>MBM</b> Base Finish	<b>AH</b> Alternate Height Base
<p>A PUX36RDWWSQWMWMBM is a Plus series 36" round table with a black powder coat X-base and a wood veneer 1.25" thick top with a 1.25" square wood edge profile.</p>						<p>Edge finish applies when edge material is different from top material.</p>	<p>The code: AH specifies alternate height base.</p>

Solid Surface

Corian® Group A	Corian® Group B
 C1FL Flat	 C2FL Flat
 C1BN Bullnose	 C2BN Bullnose
 C1PR Prism	 C2PR Prism

2,369	2,468
3,035	3,161
3,839	3,999
4,587	4,778
5,577	5,809
6,640	6,916
7,692	8,012
-	-
-	-
-	-
-	-
-	-
-	-
-	-
-	-
-	-
-	-
-	-
2,208	2,300
2,833	2,951
3,614	3,765
4,460	4,646
5,284	5,504

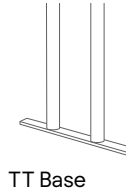
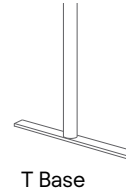
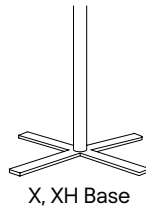

Options

Base Finishes

Custom Powder Coat (set-up charge)	CPC	📞
Polished or Satin Chrome (per X base)	use finish code	434
Polished or Satin Chrome (T & TT base, per column)	use finish code	217
Premium Plated (per X base)	use finish code	751
Premium Plated (T & TT base, per column)	use finish code	404
Stainless Steel (per base)	use finish code	1,733

Base Options

Counter, Bar, & Alternate Height (per column)	CH, BH, AH	80
Super Level Glides (per base)	GSL	42
Locking Casters 2" Twin Wheel (qty. 4)	TWC2	68
Tilt-top - (standard cable release)	TMX/TMT	📞
Folding	FM	📞

Top Materials and Finishes

Any non-standard WCI Laminates (set-up charge)	use manufacturers finish code	173
Premium Laminates	PL	📞
Custom Wood Veneer	CWV	📞
Stain to Match (set-up charge)	STM	500

Top Options

3" Radius Corner (per corner)	CRL3	42
(Laminate self edge & Corian®)		
3" Wood Radius Corner (per corner)	CRW3	100
(not available in LWFL and WWFL)		
Custom Radius Corner	CRC	100
Custom Size	CS	📞
Custom Shape	CSH	📞
Custom Edge Thickness	CET	📞
Ganging Clips (1 set includes 2 male and 2 female clips)	GC	180

Grommets

2" Round Metal Grommet - Matte Black	GMBM	167
2" Round Metal Grommet - Satin Chrome	GMSC	167
2" Round Metal Grommet - Polished Chrome	GMPC	167
2" Round Plastic Grommet - Matte Black	GPMBM	54
Grommet location	use location code	n/c

Power, Data, & Wire Management

Wire management	Pages 200-203
Power & data	Pages 236-237

📞 Call for pricing

415.621.6656

# PLUS – Dining & Multipurpose

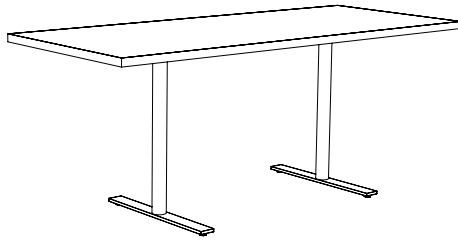

## Laminate Surface

## Wood Surface

Self Edge	Vinyl Edges	PVC Edges	Wood Edges Group A	Wood Edges Group B	Wood Edges Group A	Wood Edges Group B	Butcher Block
LLSE Self Edge	LVFL Flat	LPVC PVC	LWFL Flat	LWSQ Square	WWFL Flat	WWSQ Square	BBFL Flat
	LVBP Bumper		LWTP Tapered Ply	LWBN Bullnose	WWTP Tapered Ply	WWBN Bullnose	BBBN Bullnose
			LWFP Flat Ply	LWPR Prism	WWFP Flat Ply	WWPR Prism	

## Complete Table List Pricing

	Top Size	Base Qty.	Base Style	Model #								
Rectangle	18 48	2	T	PUT1848RE	1,516	1,516	1,603	1,805	2,233	1,917	2,282	2,427
	18 60	2	T	PUT1860RE	1,600	1,600	1,704	1,942	2,427	2,053	2,527	2,544
	18 72	2	T	PUT1872RE	1,681	1,681	1,794	2,087	2,622	2,204	2,770	2,740
	18 84	2	T	PUT1884RE	1,942	1,942	2,031	2,336	2,865	2,498	3,090	3,012
	18 96	2	T	PUT1896RE	2,087	2,087	2,167	2,435	3,059	2,605	3,269	3,206
	24 30	1	X	PUX2430RE	1,410	1,410	1,492	1,824	2,143	1,961	2,281	2,308
	24 36	1	X	PUX2436RE	1,586	1,586	1,676	2,058	2,369	2,170	2,521	2,667
	24 42	1	X	PUX2442RE	1,643	1,643	1,721	2,128	2,472	2,249	2,635	2,999
	24 48	1	X	PUX2448RE	1,705	1,705	1,801	2,252	2,635	2,390	2,816	3,094
	24 60	2	T	PUT2460RE	1,713	1,713	1,816	2,300	2,735	2,452	2,941	3,426
	24 72	2	T	PUT2472RE	1,813	1,813	1,933	2,467	2,964	2,643	3,203	3,856
	24 84	2	T	PUT2484RE	2,186	2,186	2,298	2,608	3,448	2,802	3,748	4,172
	24 96	2	T	PUT2496RE	2,286	2,286	2,409	2,749	3,657	2,958	3,981	4,487
	30 36	1	X	PUX3036RE	1,664	1,664	1,742	2,149	2,489	2,274	2,654	2,960
	30 42	2	T	PUT3042RE	1,746	1,746	1,835	2,332	2,715	2,475	2,905	3,402
	30 48	1	X	PUX3048RE	1,917	1,917	2,014	2,519	2,933	2,674	3,138	3,613
	30 60	2	T	PUT3060RE	1,947	1,947	2,056	2,602	3,076	2,779	3,310	4,017
	30 72	2	T	PUT3072RE	2,065	2,065	2,198	2,731	3,271	2,927	3,527	4,541
	30 84	2	T	PUT3084RE	2,464	2,464	2,577	2,895	3,734	3,108	4,049	4,855
	30 96	2	T	PUT3096RE	2,585	2,585	2,709	3,058	4,031	3,292	4,384	5,170
	36 42	2	T	PUT3642RE	1,953	1,953	2,054	2,554	2,975	2,713	3,180	3,894
	36 48	2	T	PUT3648RE	2,023	2,023	2,129	2,646	3,096	2,813	3,315	4,008
	36 60	2	T	PUT3660RE	2,187	2,187	2,311	2,826	3,336	3,018	3,590	4,604
	36 72	2	T	PUT3672RE	2,328	2,328	2,462	3,047	3,622	3,262	3,913	5,208
	36 84	2	T	PUT3684RE	2,749	2,749	2,869	3,227	4,026	3,467	4,366	5,809
	36 96	2	TT	PUTT3696RE	3,109	3,109	3,252	3,626	4,545	3,888	4,921	6,621

Continued on next page

\*T-bases can be specified on 30" x 42" and 30" x 48" rectangle tables, please refer to Base Only Pricing and Top Only Pricing.

X-bases are recommended for dining applications.

## How to Order







Table Model Number							Options
PUT Base Series	3672 Top Size	RA Top Shape	WWSQ Top Material Edge Profile	WMW Top Finish	N/A Edge Finish	MBM Base Finish	TWC2 Casters

A PUT3672RAWWSQWMWMBM is a Plus series 36"x 72" racetrack table with two black powder coated T-bases and a wood veneer 1.25" thick top with a 1.25" square wood edge profile.

Edge finish applies when edge material is different from top material.

The code: TWC2 specifies 2" twin wheel locking casters.

Solid Surface

Corian® Group A	Corian® Group B
 C1FL Flat	 C2FL Flat
 C1BN Bullnose	 C2BN Bullnose
 C1PR Prism	 C2PR Prism

-	-
-	-
-	-
-	-
-	-
2,574	2,681
2,930	3,053
3,143	3,274
3,359	3,499
3,721	3,876
4,176	4,351
-	-
-	-
3,242	3,377
3,528	3,675
3,939	4,103
4,365	4,547
4,912	5,116
-	-
-	-
4,394	4,577
5,020	5,229
5,062	5,273
5,688	5,925
-	-
-	-

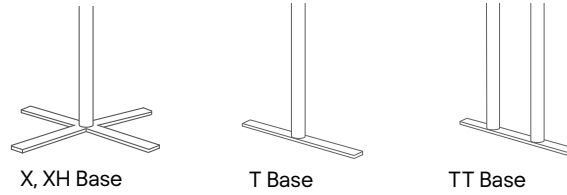

Options

Base Finishes

Custom Powder Coat (set-up charge)	CPC	Call for pricing
Polished or Satin Chrome (per X base)	use finish code	434
Polished or Satin Chrome (T & TT base, per column)	use finish code	217
Premium Plated (per X base)	use finish code	751
Premium Plated (T & TT base, per column)	use finish code	404
Stainless Steel (per base)	use finish code	1,733

Base Options

Counter, Bar, & Alternate Height (per column)	CH, BH, AH	80
Super Level Glides (per base)	GSL	42
Locking Casters 2" Twin Wheel (qty. 4)	TWC2	68
Tilt-top - (standard cable release)	TMX/TMT	Call for pricing
Folding	FM	Call for pricing

Top Materials and Finishes

Any non-standard WCI Laminates (set-up charge)	use manufacturers finish code	173
Premium Laminates	PL	Call for pricing
Custom Wood Veneer	CWV	Call for pricing
Stain to Match (set-up charge)	STM	500

Top Options

3" Radius Corner (per corner) (Laminate self edge & Corian®)	CRL3	42
3" Wood Radius Corner (per corner) (not available in LWFL and WWFL)	CRW3	100
Custom Radius Corner	CRC	100
Custom Size	CS	Call for pricing
Custom Shape	CSH	Call for pricing
Custom Edge Thickness	CET	Call for pricing
Ganging Clips (1 set includes 2 male and 2 female clips)	GC	180

Grommets

2" Round Metal Grommet - Matte Black	GMBM	167
2" Round Metal Grommet - Satin Chrome	GMSC	167
2" Round Metal Grommet - Polished Chrome	GMPC	167
2" Round Plastic Grommet - Matte Black	GPMBM	54
Grommet location	use location code	n/c



















Power, Data, & Wire Management

Wire management	Pages 200-203
Power & data	Pages 236-237

Call for pricing

415.621.6656

# PLUS – Dining & Multipurpose

Laminate Surface						Wood Surface					
Self Edge	Vinyl Edges	PVC Edges	Wood Edges Group A	Wood Edges Group B	Wood Edges Group A	Wood Edges Group B	Butcher Block				
 LLSE Self Edge	 LVFL Flat	 LPVC PVC	 LWFL Flat	 LWSQ Square	 WWFL Flat	 WWSQ Square	 BBFL Flat				
	 LVBP Bumper		 LWTP Tapered Ply	 LWBN Bullnose	 WWTP Tapered Ply	 WWBN Bullnose	 BBBN Bullnose				
			 LWFP Flat Ply	 LWPR Prism	 WWFP Flat Ply	 WWPR Prism					

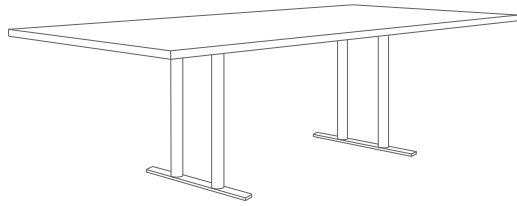







## Complete Table List Pricing

	Top Size	Base Qty.	Base Style	Model #								
Rectangle	42 72	2	TT	PUTT4272RE	2,692	2,692	2,804	3,377	4,057	3,499	4,216	-
	42 84	2	TT	PUTT4284RE	3,132	3,132	3,252	3,571	4,447	3,979	4,984	-
	42 96	2	TT	PUTT4296RE	3,293	3,293	3,425	3,781	4,835	4,222	5,059	-
	48 96	2	TT	PUTT4896RE	3,603	3,603	3,733	4,220	5,345	4,859	5,698	-
	48 120	2	TT	PUTT48120RE	3,969	3,969	4,135	4,636	5,734	5,384	6,223	-

## How to Order

Table Model Number							Options	
<b>PUT</b> Base Series	<b>3672</b> Top Size	<b>RE</b> Top Shape	<b>WWSQ</b> Top Material Edge Profile	<b>WMW</b> Top Finish	<b>N/A</b> Edge Finish	<b>MBM</b> Base Finish	<b>GMBM</b> Matte Black Grommet	<b>E</b> Location "E"
A PUT3672REWWSQWMWMBM is a Plus series 36" x 72" rectangle table with two black powder coated T-bases and a wood veneer 1.25" thick top with a 1.25" square wood edge profile.						Edge finish applies when edge material is different from top material.	The code: GMBM specifies a matte black 2" diameter metal grommet.	The code: E specifies the location of the grommet.

Solid Surface

Corian® Group A	Corian® Group B
 C1FL Flat	 C2FL Flat
 C1BN Bullnose	 C2BN Bullnose
 C1PR Prism	 C2PR Prism

-	-
-	-
-	-
-	-
-	-
-	-

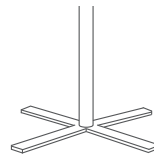

X, XH Base

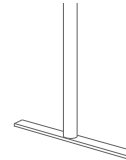

T Base

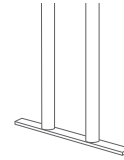

TT Base

Options

Base Finishes

Custom Powder Coat (set-up charge)	CPC	🔒
Polished or Satin Chrome (per X base)	use finish code	434
Polished or Satin Chrome (T & TT base, per column)	use finish code	217
Premium Plated (per X base)	use finish code	751
Premium Plated (T & TT base, per column)	use finish code	404
Stainless Steel (per base)	use finish code	1,733

Base Options

Counter, Bar, & Alternate Height (per column)	CH, BH, AH	80
Super Level Glides (per base)	GSL	42
Locking Casters 2" Twin Wheel (qty. 4)	TWC2	68
Tilt-top - (standard cable release)	TMX/TMT	🔒
Folding	FM	🔒

Top Materials and Finishes

Any non-standard WCI Laminates (set-up charge)	use manufacturers finish code	173
Premium Laminates	PL	🔒
Custom Wood Veneer	CWV	🔒
Stain to Match (set-up charge)	STM	500

Top Options

3" Radius Corner (per corner)	CRL3	42
(Laminate self edge & Corian®)		
3" Wood Radius Corner (per corner)	CRW3	100
(not available in LWFL and WWFL)		
Custom Radius Corner	CRC	100
Custom Size	CS	🔒
Custom Shape	CSH	🔒
Custom Edge Thickness	CET	🔒
Ganging Clips (1 set includes 2 male and 2 female clips)	GC	180

Grommets

2" Round Metal Grommet - Matte Black	GMBM	167
2" Round Metal Grommet - Satin Chrome	GMSC	167
2" Round Metal Grommet - Polished Chrome	GMPC	167
2" Round Plastic Grommet - Matte Black	GPMBM	54
Grommet location	use location code	n/c











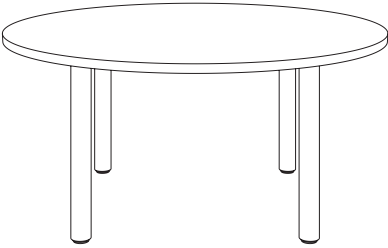







Power, Data, & Wire Management

Wire management	Pages 200-203
Power & data	Pages 236-237





🔒 Call for pricing

415.621.6656

# POST LEG – Multipurpose

	Laminate Surface					Wood Surface					
	Self Edge	Vinyl Edges	PVC Edges	Wood Edges Group A	Wood Edges Group B	Wood Edges Group A	Wood Edges Group B	Butcher Block			
	 LLSE Self Edge	 LVFL Flat	 LPVC PVC	 LWFL Flat	 LWSQ Square	 WWFL Flat	 WWSQ Square	 BBFL Flat			
		 LVBP Bumper		 LWTP Tapered Ply	 LWBN Bullnose	 WWTP Tapered Ply	 WWBN Bullnose	 BBBN Bullnose			
				 LWFP Flat Ply	 LWPR Prism	 WWFP Flat Ply	 WWPR Prism				

## Complete Table List Pricing







	Top Size	Base Qty.	Model #									
<b>Round</b> 	36	4	PO36RD	1,708	1,708	1,830	2,222	2,571	2,265	2,747	3,009	
	42	4	PO42RD	1,951	1,951	2,087	2,489	2,921	2,646	3,131	3,960	
	48	4	PO48RD	2,124	2,124	2,275	2,721	3,217	2,907	3,465	4,420	
	54	4	PO54RD	2,310	2,310	2,486	3,083	4,106	3,314	4,463	-	
	60	4	PO60RD	2,605	2,605	2,793	3,283	4,242	3,884	4,620	-	
<b>Oval</b> 	36	72	4	PO3672OV	2,201	2,201	2,286	2,633	3,005	2,922	3,284	-
	42	54	4	PO4254OV	2,237	2,237	2,283	2,625	3,170	2,876	3,272	-
	42	78	4	PO4278OV	2,725	2,725	2,795	3,117	3,485	3,355	3,768	-
	42	84	4	PO4284OV	2,818	2,818	2,909	3,201	3,620	3,444	3,919	-
	48	78	4	PO4878OV	2,876	2,876	2,973	3,255	3,671	3,510	3,978	-
	48	96	4	PO4896OV	3,170	3,170	3,265	3,503	3,957	4,108	4,637	-
<b>RD Square</b> 	36	36	4	PO3636RS	1,708	1,708	1,821	2,204	2,571	2,265	2,747	3,205
	42	42	4	PO4242RS	1,930	1,930	2,058	2,490	2,921	2,646	3,131	4,269
	48	48	4	PO4848RS	2,126	2,126	2,275	2,721	3,217	2,907	3,465	4,782
<b>square</b> 	36	36	4	PO3636SQ	1,708	1,708	1,821	2,204	2,571	2,265	2,747	3,205
	42	42	4	PO4242SQ	1,930	1,930	2,058	2,490	2,921	2,646	3,131	4,269
	48	48	4	PO4848SQ	2,126	2,126	2,275	2,721	3,217	2,907	3,465	4,782

Continued on next page

## How to Order

Table Model Number							Options
<b>PO</b> Base Series	<b>36</b> Top Size	<b>RD</b> Top Shape	<b>WWSQ</b> Top Material Edge Profile	<b>WMW</b> Top Finish	<b>N/A</b> Edge Finish	<b>MBM</b> Base Finish	<b>AH</b> Alternate Height Base
<p>A PO36RDWWSQWMWMBM is a Post Leg series 36" round table with four black powder coat post legs and a wood veneer 1.25" thick top with a 1.25" square wood edge profile.</p>				<p>Edge finish applies when edge material is different from top material.</p>		<p>The code: AH specifies alternate height base.</p>	

Solid Surface

Corian® Group A	Corian® Group B
 C1FL Flat	 C2FL Flat
 C1BN Bullnose	 C2BN Bullnose
 C1PR Prism	 C2PR Prism



3,872	4,033
4,704	4,901
5,552	5,783
6,477	6,747
7,529	7,843
-	-
-	-
-	-
-	-
-	-
-	-
-	-
-	-
-	-
3,646	3,798
4,435	4,620
5,258	5,477

Options

Base Finishes		
Custom Powder Coat (set-up charge)	CPC	92
Polished or Satin Chrome (per leg)	use finish code	92
Premium Plated (per leg)	use finish code	145
Stainless Steel (per leg)	use finish code	1,733

Base Options		
Counter, Bar, & Alternate Height (per column)	CH, BH, AH	80
Locking Casters 2" Twin Wheel (qty. 4)	TWC2	68

Top Materials and Finishes		
Any non-standard WCI Laminates (set-up charge)	use manufacturers finish code	173
Premium Laminates	PL	92
Custom Wood Veneer	CWV	92
Stain to Match (set-up charge)	STM	500

Top Options		
3" Radius Corner (per corner) (Laminate self edge & Corian®)	CRL3	42
3" Wood Radius Corner (per corner) (not available in LWFL and WWFL)	CRW3	100
Custom Radius Corner	CRC	100
Custom Size	CS	92
Custom Shape	CSH	92
Custom Edge Thickness	CET	92

Additional options available Pages 200-203

Grommets		
2" Round Metal Grommet - Matte Black	GMBM	167
2" Round Metal Grommet - Satin Chrome	GMSC	167
2" Round Metal Grommet - Polished Chrome	GMPC	167
2" Round Plastic Grommet - Matte Black	GPMBM	53
Grommet location	use location code	n/c

Call for pricing

415.621.6656

# POST LEG – Multipurpose

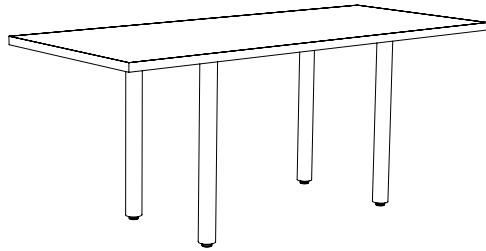

## Laminate Surface

## Wood Surface

Self Edge	Vinyl Edges	PVC Edges	Wood Edges Group A	Wood Edges Group B	Wood Edges Group A	Wood Edges Group B	Butcher Block
LLSE Self Edge	LVFL Flat	LPVC PVC	LWFL Flat	LWSQ Square	WWFL Flat	WWSQ Square	BBFL Flat
	LVBP Bumper		LWTP Tapered Ply	LWBN Bullnose	WWTP Tapered Ply	WWBN Bullnose	BBBN Bullnose
			LWFP Flat Ply	LWPR Prism	WWFP Flat Ply	WWPR Prism	

## Complete Table List Pricing

	Top Size	Base Qty.	Model #									
Rectangle	30	60	4	PO3060RE	1,901	1,901	2,007	2,538	2,998	2,710	3,226	3,913
	30	72	4	PO3072RE	2,015	2,015	2,145	2,663	3,188	2,854	3,437	4,422
	30	84	4	PO3084RE	2,404	2,404	2,513	2,823	3,638	3,030	3,944	4,729
	30	96	4	PO3096RE	2,521	2,521	2,641	2,981	3,927	3,209	4,270	5,035
	36	42	4	PO3642RE	1,784	1,784	1,883	2,369	2,778	2,524	2,978	3,673
	36	48	4	PO3648RE	1,853	1,853	1,955	2,459	2,896	2,621	3,108	3,783
	36	60	4	PO3660RE	2,012	2,012	2,132	2,633	3,129	2,819	3,376	4,361
	36	72	4	PO3672RE	2,149	2,149	2,279	2,848	3,407	3,058	3,690	4,949
	36	84	4	PO3684RE	2,558	2,558	2,676	3,023	3,800	3,256	4,130	5,534
	36	96	4	PO3696RE	2,697	2,697	2,834	3,198	4,092	3,453	4,458	6,111
	42	72	4	PO4272RE	2,364	2,364	2,473	3,031	3,691	3,149	3,846	-
	42	84	4	PO4284RE	2,792	2,792	2,909	3,220	4,071	3,616	4,593	-
	42	96	4	PO4296RE	2,950	2,950	3,077	3,423	4,449	3,852	4,666	-
	48	96	4	PO4896RE	3,134	3,134	3,261	3,733	4,827	4,356	5,171	-
	48	120	6	PO48120RE	4,106	4,106	4,268	4,754	5,822	5,482	6,297	-

## How to Order

### Table Model Number

<b>PO</b> Base Series	<b>4896</b> Top Size	<b>RA</b> Top Shape	<b>WWSQ</b> Top Material Edge Profile	<b>WMW</b> Top Finish	<b>N/A</b> Edge Finish	<b>MBM</b> Base Finish
--------------------------	-------------------------	------------------------	---	--------------------------	---------------------------	---------------------------

### Options

<b>GMBM</b> Matte Black Grommet	<b>E</b> Location "E"
---------------------------------------	--------------------------







A PO4896RAWWSQWMWMBM is a Post Leg series 48" x 96" racetrack table with four black powder coat post legs and a wood veneer 1.25" thick top with a 1.25" square wood edge profile.

Edge finish applies when edge material is different from top material.

The code: GMBM specifies a matte black 2" diameter metal grommet.

The code: E specifies the location of the grommet.

Solid Surface

Corian® Group A	Corian® Group B
 <b>C1FL</b> Flat	 <b>C2FL</b> Flat
 <b>C1BN</b> Bullnose	 <b>C2BN</b> Bullnose
 <b>C1PR</b> Prism	 <b>C2PR</b> Prism

4,373	4,555
4,921	5,126
-	-
-	-
4,264	4,441
4,889	5,093
4,932	5,137
5,557	5,789
-	-
-	-
-	-
-	-
-	-
-	-
-	-



Options

Base Finishes

Custom Powder Coat (set-up charge)	CPC	92
Polished or Satin Chrome (per leg)	use finish code	92
Premium Plated (per leg)	use finish code	145
Stainless Steel (per leg)	use finish code	1,733

Base Options

Counter, Bar, & Alternate Height (per column)	CH, BH, AH	80
Locking Casters 2" Twin Wheel (qty. 4)	TWC2	68

Top Materials and Finishes

Any non-standard WCI Laminates (set-up charge)	use manufacturers finish code	173
Premium Laminates	PL	92
Custom Wood Veneer	CWV	92
Stain to Match (set-up charge)	STM	500

Top Options

3" Radius Corner (per corner) (Laminate self edge & Corian®)	CRL3	42
3" Wood Radius Corner (per corner) (not available in LWFL and WWFL)	CRW3	100
Custom Radius Corner	CRC	100
Custom Size	CS	92
Custom Shape	CSH	92
Custom Edge Thickness	CET	92

Additional options available

Pages 200-203











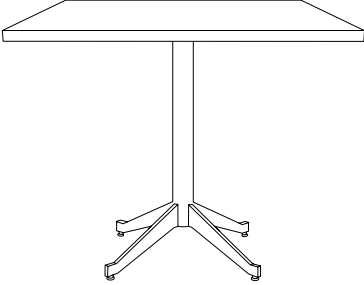







Grommets

2" Round Metal Grommet - Matte Black	GMBM	167
2" Round Metal Grommet - Satin Chrome	GMSC	167
2" Round Metal Grommet - Polished Chrome	GMPC	167
2" Round Plastic Grommet - Matte Black	GPMBM	53
Grommet location	use location code	n/c



Call for pricing

415.621.6656

# REGENCY – Dining & Multipurpose

	Laminate Surface					Wood Surface						
	Self Edge	Vinyl Edges	PVC Edges	Wood Edges Group A	Wood Edges Group B	Wood Edges Group A	Wood Edges Group B	Butcher Block				
	 LLSE Self Edge	 LVFL Flat	 LPVC PVC	 LWFL Flat	 LWSQ Square	 WWFL Flat	 WWSQ Square	 BBFL Flat				
		 LVBP Bumper		 LWTP Tapered Ply	 LWBN Bullnose	 WWTP Tapered Ply	 WWBN Bullnose	 BBBN Bullnose				
				 LWFP Flat Ply	 LWPR Prism	 WWFP Flat Ply	 WWPR Prism					

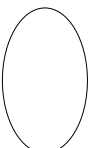
## Complete Table List Pricing

	Top Size	Base Qty.	Base Style	Model #								
<b>Round</b>  	30	1	X	RGX30RD	1,931	1,931	2,027	2,345	2,632	2,455	2,772	2,807
	36	1	X	RGX36RD	2,184	2,184	2,299	2,673	3,005	2,714	3,172	3,422
	42	1	X	RGX42RD	2,344	2,344	2,473	2,857	3,267	3,005	3,467	4,258
	48	1	X	RGX48RD	4,378	4,378	4,522	4,948	5,420	5,125	5,656	6,566
	54	1	X	RGX54RD	4,555	4,555	4,722	5,291	6,266	5,512	6,606	-
	60	1	X	RGX60RD	4,836	4,836	5,016	5,481	6,395	6,054	6,755	-
<b>Oval</b>  	36 72	1	S	RGS3672OV	5,630	5,630	5,710	6,041	6,395	6,316	6,661	-
	42 54	1	S	RGS4254OV	5,592	5,592	5,636	5,962	6,482	6,202	6,579	-
	42 78	1	S	RGS4278OV	6,058	6,058	6,124	6,432	6,782	6,658	7,051	-
	42 84	1	S	RGS4284OV	6,324	6,324	6,410	6,688	7,087	6,920	7,372	-
	48 78	1	S	RGS4878OV	6,379	6,379	6,471	6,739	7,136	6,983	7,427	-
	48 96	1	S	RGS4896OV	6,659	6,659	6,749	6,975	7,407	7,552	8,056	-
<b>RD Square</b>  	30 30	1	X	RGX3030RS	1,929	1,929	2,037	2,345	2,632	2,455	2,772	2,955
	36 36	1	X	RGX3636RS	2,184	2,184	2,291	2,655	3,005	2,714	3,172	3,609
	42 42	1	X	RGX4242RS	4,194	4,194	4,315	4,727	5,137	4,875	5,337	6,421
	48 48	1	X	RGX4848RS	4,381	4,381	4,522	4,948	5,420	5,125	5,656	6,910

Continued on next page

## How to Order

Table Model Number							Options
<b>RGS</b> Base Series	<b>3672</b> Top Size	<b>OV</b> Top Shape	<b>WWSQ</b> Top Material Edge Profile	<b>WMW</b> Top Finish	<b>N/A</b> Edge Finish	<b>MBM</b> Base Finish	<b>AH</b> Alternate Height Base
<p>A RGS3672OVWWSQWMWMBM is a Regency series 36" x 72" oval table with a black powder coat scissor base and a wood veneer 1.25" thick top with a 1.25" square wood edge profile.</p>					<p>Edge finish applies when edge material is different from top material.</p>		<p>The code: AH specifies alternate height base.</p>



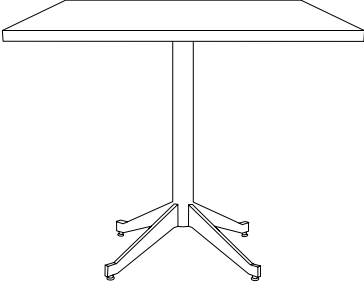

# REGENCY – Dining & Multipurpose













Laminate Surface				Wood Surface			
Self Edge	Vinyl Edges	PVC Edges	Wood Edges Group A	Wood Edges Group B	Wood Edges Group A	Wood Edges Group B	Butcher Block
LLSE Self Edge	LVFL Flat	LPVC PVC	LWFL Flat	LWSQ Square	WWFL Flat	WWSQ Square	BBFL Flat
	LVBP Bumper		LWTP Tapered Ply	LWBN Bullnose	WWTP Tapered Ply	WWBN Bullnose	BBBN Bullnose
			LWFP Flat Ply	LWPR Prism	WWFP Flat Ply	WWPR Prism	

## Complete Table List Pricing

	Top Size		Base Qty.	Base Style	Model #								
Square 	30	30	1	X	RGX3030SQ	1,929	1,929	2,037	2,345	2,632	2,455	2,772	2,955
	36	36	1	X	RGX3636SQ	2,184	2,184	2,291	2,655	3,005	2,714	3,172	3,609
	42	42	1	X	RGX4242SQ	4,194	4,194	4,315	4,727	5,137	4,875	5,337	6,421
	48	48	1	X	RGX4848SQ	4,381	4,381	4,522	4,948	5,420	5,125	5,656	6,910
Rectangle 	30	48	1	X	RGX3048RE	2,240	2,240	2,329	2,796	3,180	2,940	3,369	3,809

## How to Order

Table Model Number							Options
RGS Base Series	3672 Top Size	OV Top Shape	WWSQ Top Material Edge Profile	WMW Top Finish	N/A Edge Finish	MBM Base Finish	AH Alternate Height Base
A RGS3672OVWWSQWMWMBM is a Regency series 36" x 72" oval table with a black powder coat scissor base and a wood veneer 1.25" thick top with a 1.25" square wood edge profile.					Edge finish applies when edge material is different from top material.		The code: AH specifies alternate height base.

Solid Surface		Quartz Surface	
Corian® Group A	Corian® Group B	Quartz Group A	Quartz Group B
 C1FL Flat	 C2FL Flat	 Q1FL Flat	 Q2FL Flat
 C1BN Bullnose	 C2BN Bullnose	 Q1BN Bullnose	 Q2BN Bullnose
 C1PR Prism	 C2PR Prism		

3,522	3,669	4,351	5,998
4,314	4,494	5,355	7,316
7,261	7,564	8,564	10,425
8,085	8,422	-	-

4,496	4,683	-	-
-------	-------	---	---

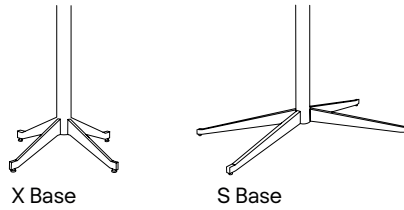

### Options

#### Base Finishes

Custom Powder Coat (set-up charge)	CPC	☎
Polished or Satin Chrome (per base)	use finish code	866
Premium Plated (per base)	use finish code	1,733

#### Base Options

Counter, Bar, & Alternate Height (per column)	CH, BH, AH	80
Base sizes may vary with quartz tops		

#### Top Materials and Finishes

Any non-standard WCI Laminates (set-up charge)	use manufacturers finish code	173
Premium Laminates	PL	☎
Custom Wood Veneer	CWV	☎
Stain to Match (set-up charge)	STM	500

#### Top Options

3" Radius Corner (per corner) (Laminate self edge & Corian®)	CRL3	42
3" Wood Radius Corner (per corner) (not available in LWFL and WWFL)	CRW3	100
Custom Radius Corner	CRC	100
Custom Size	CS	☎
Custom Shape	CSH	☎
Custom Edge Thickness	CET	☎

#### Grommets

2" Round Metal Grommet - Matte Black	GMBM	167
2" Round Metal Grommet - Satin Chrome	GMSC	167
2" Round Metal Grommet - Polished Chrome	GMPC	167
2" Round Plastic Grommet - Matte Black	GPMBM	53
Grommet location	use location code	n/c

☎ Call for pricing



415.621.6656

# TULIP – Dining & Multipurpose



Laminate Surface					Wood Surface				
Self Edge	Vinyl Edges	PVC Edges	Wood Edges Group A	Wood Edges Group B	Wood Edges Group A	Wood Edges Group B	Butcher Block		
LLSE Self Edge	LVFL Flat	LPVC PVC	LWFL Flat	LWSQ Square	WWFL Flat	WWSQ Square	BBFL Flat		
	LVBP Bumper		LWTP Tapered Ply	LWBN Bullnose	WWTP Tapered Ply	WWBN Bullnose	BBBN Bullnose		
			LWFP Flat Ply	LWPR Prism	WWFP Flat Ply	WWPR Prism			

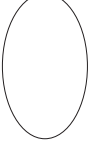









## Complete Table List Pricing

	Top Size		Base Qty.	Base Style	Model #								
Round 	24		1	18L	TL24RD	1,381	1,381	1,468	1,746	2,041	1,763	2,168	2,021
	30		1	18M	TL30RD	1,584	1,584	1,690	2,040	2,356	2,161	2,508	2,548
	36		1	18H	TL36RD	1,846	1,846	1,974	2,385	2,752	2,430	2,934	3,209
	42		1	24M	TL42RD	2,091	2,091	2,234	2,655	3,107	2,819	3,328	4,196
	48		1	24H	TL48RD	2,476	2,476	2,634	3,101	3,620	3,296	3,880	4,881
	54		1	24XH	TL54RD	2,730	2,730	2,914	3,540	4,611	3,782	4,985	-
Oval 	36	72	2	18H	TL3672OV	3,634	3,634	3,722	4,087	4,477	4,389	4,767	-
	42	54	2	18H	TL4254OV	3,592	3,592	3,641	3,999	4,571	4,263	4,678	-
	42	78	2	24M	TL4278OV	4,240	4,240	4,314	4,651	5,037	4,902	5,332	-
	42	84	2	24M	TL4284OV	4,339	4,339	4,433	4,740	5,179	4,995	5,492	-
	48	78	2	24H	TL4878OV	4,806	4,806	4,907	5,202	5,637	5,469	5,959	-
	48	96	2	24H	TL4896OV	5,115	5,115	5,213	5,462	5,937	6,096	6,651	-
RD Square 	24	24	1	18L	TL2424RS	1,383	1,383	1,479	1,746	2,041	1,763	2,168	2,143
	30	30	1	18M	TL3030RS	1,583	1,583	1,701	2,040	2,356	2,161	2,508	2,709
	36	36	1	18H	TL3636RS	1,848	1,848	1,965	2,366	2,752	2,430	2,935	3,415
	42	42	1	24H	TL4242RS	2,272	2,272	2,407	2,859	3,311	3,023	3,531	4,723
	48	48	1	24XH	TL4848RS	2,539	2,539	2,695	3,162	3,681	3,357	3,941	5,320
Square 	24	24	1	18L	TL2424SQ	1,383	1,383	1,479	1,746	2,041	1,763	2,168	2,143
	30	30	1	18M	TL3030SQ	1,583	1,583	1,701	2,040	2,356	2,161	2,508	2,709
	36	36	1	18H	TL3636SQ	1,848	1,848	1,965	2,366	2,752	2,430	2,935	3,415
	42	42	1	24H	TL4242SQ	2,272	2,272	2,407	2,859	3,311	3,023	3,531	4,723
	48	48	1	24XH	TL4848SQ	2,539	2,539	2,695	3,162	3,681	3,357	3,941	5,320

Continued on next page

## How to Order

Table Model Number							Options
<b>TL</b> Base Series	<b>36</b> Top Size	<b>RD</b> Top Shape	<b>WWSQ</b> Top Material Edge Profile	<b>WMW</b> Top Finish	<b>N/A</b> Edge Finish	<b>MBM</b> Base Finish	<b>GSL</b> Super Level Glides
<p>A TL36RDWWSQWMWMBM is a Tulip series 36" round table with a black powder coat, round base and a wood veneer 1.25" thick top with a 1.25" square wood edge profile.</p>							<p>The code: GSL specifies super level glides.</p>
<p>Edge finish applies when edge material is different from top material.</p>							

Solid Surface		Quartz Surface	
Corian® Group A	Corian® Group B	Quartz Group A	Quartz Group B
 C1FL Flat	 C2FL Flat	 Q1FL Flat	 Q2FL Flat
 C1BN Bullnose	 C2BN Bullnose	 Q1BN Bullnose	 Q2BN Bullnose
 C1PR Prism	 C2PR Prism		

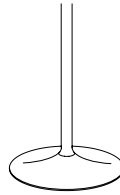

**Options**

**Base Finishes**

Custom Powder Coat (set-up charge)	CPC	📞
Polished or Satin Chrome (per base)	use finish code	289
Premium Plated (per base)	use finish code	578
Stainless Steel (per base)	use finish code	1,733

**Base Options**

Counter, Bar, & Alternate Height (per column)	CH, BH, AH	80
Super Level Glides (per base)	GSL	42
Custom Top Plate Size	CTPS	📞
6" Column (black texture and powder coat)	COL6	235
6" Column (polished or satin chrome)	COLP6	300
6" Column (premium plated)	COLPP6	📞
6" Column (veneer)	COLV6	468

**Top Materials and Finishes**

Any non-standard WCI Laminates (set-up charge)	use manufacturers finish code	173
Premium Laminates	PL	📞
Custom Wood Veneer	CWV	📞
Stain to Match (set-up charge)	STM	500

**Top Options**

3" Radius Corner (per corner) (Laminate self edge & Corian®)	CRL3	42
3" Wood Radius Corner (per corner) (not available in LWFL and WWFL)	CRW3	100
Custom Size	CS	📞
Custom Radius Corner	CRC	100
Custom Shape	CSH	📞
Custom Edge Thickness	CET	📞

**Grommets**

2" Round Metal Grommet - Matte Black	GMBM	167
2" Round Metal Grommet - Satin Chrome	GMSC	167
2" Round Metal Grommet - Polished Chrome	GMPC	167
2" Round Plastic Grommet - Matte Black	GPMBM	53
Grommet location	use location code	n/c

2,509	2,614	4,017	5,023
3,135	3,266	5,071	6,974
3,934	4,098	6,819	8,326
4,756	4,954	8,242	10,464
5,825	6,068	-	-
6,816	7,101	-	-
-	-	-	-
-	-	-	-
-	-	-	-
-	-	-	-
-	-	-	-
-	-	-	-
-	-	-	-
-	-	-	-
-	-	-	-
2,348	2,446	2,828	4,392
2,932	3,054	4,296	6,137
3,708	3,862	5,386	7,573
4,708	4,905	7,293	9,466
5,597	5,830	-	-

📞 Call for pricing

415.621.6656

# TULIP – Dining & Multipurpose











	Laminate Surface						Wood Surface					
	Self Edge	Vinyl Edges	PVC Edges	Wood Edges Group A	Wood Edges Group B	Wood Edges Group A	Wood Edges Group B	Butcher Block				
	LLSE Self Edge	LVFL Flat LVBP Bumper	LPVC PVC	LWFL Flat LWTP Tapered Ply LWFP Flat Ply	LWSQ Square LWBN Bullnose LWPR Prism	WWFL Flat WWTP Tapered Ply WWFP Flat Ply	WWSQ Square WWBN Bullnose WWPR Prism	BBFL Flat BBBN Bullnose				

## Complete Table List Pricing

	Top Size	Base Qty.	Base Style	Model #									
Rectangle 	24	30	1	18M	TL2430RE	1,528	1,528	1,611	1,949	2,275	2,090	2,415	2,443
	24	36	1	18H	TL2436RE	1,702	1,702	1,794	2,182	2,499	2,298	2,655	2,802
	24	42	1	24M	TL2442RE	1,828	1,828	1,907	2,322	2,673	2,445	2,837	3,209
	24	48	1	24H	TL2448RE	2,093	2,093	2,191	2,651	3,041	2,791	3,225	3,509
	24	60	2	18L	TL2460RE	2,760	2,760	2,866	3,359	3,802	3,513	4,012	4,506
	24	72	2	18L	TL2472RE	2,862	2,862	2,985	3,528	4,035	3,707	4,279	4,944
	24	84	2	18L	TL2484RE	3,242	3,242	3,355	3,672	4,528	3,870	4,833	5,265
	24	96	2	18L	TL2496RE	3,343	3,343	3,469	3,815	4,740	4,029	5,070	5,585
	30	36	1	18H	TL3036RE	1,781	1,781	1,860	2,276	2,622	2,402	2,790	3,101
	30	42	1	24M	TL3042RE	1,912	1,912	2,003	2,510	2,899	2,654	3,092	3,599
	30	48	1	24H	TL3048RE	2,179	2,179	2,277	2,791	3,214	2,951	3,423	3,906
	30	60	2	18M	TL3060RE	3,071	3,071	3,184	3,738	4,220	3,919	4,460	5,180
	30	72	2	18M	TL3072RE	3,191	3,191	3,326	3,871	4,419	4,070	4,680	5,712
	30	84	2	18M	TL3084RE	3,597	3,597	3,713	4,037	4,891	4,254	5,213	6,033
	30	96	2	18M	TL3096RE	3,721	3,721	3,847	4,202	5,193	4,441	5,554	6,355
	36	42	1	24M	TL3642RE	1,995	1,995	2,098	2,608	3,036	2,770	3,245	3,972
	36	48	1	24H	TL3648RE	2,270	2,270	2,378	2,904	3,363	3,073	3,585	4,291
	36	60	2	18H	TL3660RE	3,435	3,435	3,562	4,087	4,606	4,282	4,864	5,896
	36	72	2	18H	TL3672RE	3,579	3,579	3,715	4,311	4,897	4,531	5,193	6,512
	36	84	2	18H	TL3684RE	4,008	4,008	4,131	4,494	5,308	4,738	5,654	7,124
	36	96	2	18H	TL3696RE	4,153	4,153	4,297	4,678	5,614	4,945	5,998	7,729
	42	72	2	24M	TL4272RE	3,864	3,864	3,977	4,562	5,254	4,685	5,416	-
	42	84	2	24M	TL4284RE	4,310	4,310	4,433	4,759	5,651	5,174	6,198	-
	42	96	2	24M	TL4296RE	4,476	4,476	4,610	4,973	6,046	5,422	6,274	-
	48	96	2	24H	TL4896RE	5,075	5,075	5,208	5,704	6,849	6,355	7,209	-
	48	120	2	24H	TL48120RE	5,447	5,447	5,618	6,127	7,247	6,890	7,744	-

## How to Order

Table Model Number							Options	
<b>TL</b> Base Series	<b>4896</b> Top Size	<b>RA</b> Top Shape	<b>WWSQ</b> Top Material Edge Profile	<b>WMW</b> Top Finish	<b>N/A</b> Edge Finish	<b>MBM</b> Base Finish	<b>GMBM</b> Matte Black Grommet	<b>C</b> Location "C"
A TL4896RAWWSQWMWMBM is a Tulip series 48" x 96" racetrack table with two black powder coat, round bases and a wood veneer 1.25" thick top with a 1.25" square wood edge profile.							Edge finish applies when edge material is different from top material.	
							The code: GMBM specifies a matte black 2" diameter metal grommet.	
							The code: C specifies the location of the grommet.	

Solid Surface		Quartz Surface	
Corian® Group A	Corian® Group B	Quartz Group A	Quartz Group B
 C1FL Flat	 C2FL Flat	 Q1FL Flat	 Q2FL Flat
 C1BN Bullnose	 C2BN Bullnose	 Q1BN Bullnose	 Q2BN Bullnose
 C1PR Prism	 C2PR Prism		

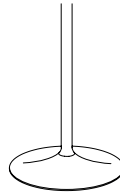

### Options

#### Base Finishes

Custom Powder Coat (set-up charge)	CPC	☎
Polished or Satin Chrome (per base)	use finish code	289
Premium Plated (per base)	use finish code	578
Stainless Steel (per base)	use finish code	1,733

#### Base Options

Counter, Bar, & Alternate Height (per column)	CH, BH, AH	80
Super Level Glides (per base)	GSL	42
Custom Top Plate Size	CTPS	☎
6" Column (black texture and powder coat)	COL6	235
6" Column (polished or satin chrome)	COLP6	300
6" Column (premium plated)	COLPP6	☎
6" Column (veneer)	COLV6	468

#### Top Materials and Finishes

Any non-standard WCI Laminates (set-up charge)	use manufacturers finish code	173
Premium Laminates	PL	☎
Custom Wood Veneer	CWV	☎
Stain to Match (set-up charge)	STM	500

#### Top Options

3" Radius Corner (per corner) (Laminate self edge & Corian®)	CRL3	42
3" Wood Radius Corner (per corner) (not available in LWFL and WWFL)	CRW3	100
Custom Size	CS	☎
Custom Radius Corner	CRC	100
Custom Shape	CSH	☎
Custom Edge Thickness	CET	☎

#### Grommets

2" Round Metal Grommet - Matte Black	GMBM	167
2" Round Metal Grommet - Satin Chrome	GMSC	167
2" Round Metal Grommet - Polished Chrome	GMPC	167
2" Round Plastic Grommet - Matte Black	GPMBM	53
Grommet location	use location code	n/c

2,674	2,786	2,895	4,973
3,025	3,152	3,274	5,577
3,312	3,450	3,706	5,967
3,749	3,905	-	-
4,829	5,030	-	-
5,284	5,504	-	-
-	-	-	-
-	-	-	-
3,336	3,475	3,948	6,409
3,674	3,827	4,255	6,633
4,186	4,360	-	-
5,552	5,783	-	-
6,100	6,354	-	-
-	-	-	-
-	-	-	-
4,400	4,583	4,946	7,731
5,247	5,466	-	-
6,380	6,645	-	-
7,005	7,297	-	-
-	-	-	-
-	-	-	-
-	-	-	-
-	-	-	-
-	-	-	-
-	-	-	-
-	-	-	-
-	-	-	-

☎ Call for pricing

415.621.6656

# VISTA – Dining & Multipurpose

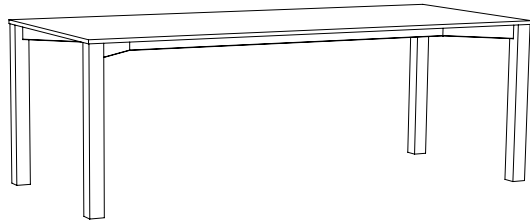

Laminate Surface		Wood Surface		Solid Surface		Quartz	
Self Edge	Wood Edges Group A	Wood Edges Group A	Butcher Block	Corian® Group A	Corian® Group B	Quartz Group A	Quartz Group B
LLSE Self Edge	LWFL Flat LWFP Flat Ply	WWFL Flat WWFP Flat Ply	BBFL Flat	C1FL Flat	C2FL Flat	Q1FL Flat	Q2FL Flat

## Complete Table List Pricing

	Top Size		Base Qty.	Model #								
Square	36	36	1	VS3636SQ	2,875	3,285	3,707	4,314	5,102	5,314	5,026	6,924
	42	42	1	VS4242SQ	3,104	3,514	4,017	4,571	5,458	5,686	6,243	8,140
	48	48	1	VS4848SQ	3,863	4,374	5,000	5,691	6,794	7,077	7,770	10,133
Rectangle	24	60	1	VS2460RE	2,698	3,090	3,489	3,773	4,524	4,712	5,119	7,143
	24	72	1	VS2472RE	3,130	3,585	4,046	4,375	5,248	5,467	5,938	8,286
	24	84	1	VS2484RE	3,546	4,063	4,587	4,961	5,948	6,196	6,730	9,392
	24	96	1	VS2496RE	3,952	4,527	5,111	5,527	6,628	6,904	7,499	10,464
	24	120	1	VS24120RE	4,742	5,432	6,132	6,633	7,953	8,284	8,999	12,557
	30	60	1	VS3060RE	3,372	3,862	4,361	4,716	5,655	5,891	6,399	8,929
	30	72	1	VS3072RE	3,608	4,133	4,666	5,146	6,113	6,368	7,704	12,930
	30	84	1	VS3084RE	3,861	4,423	4,993	5,590	6,636	6,912	10,172	13,993
	30	96	1	VS3096RE	4,302	4,928	5,563	6,229	7,395	7,703	11,334	15,593
	30	120	1	VS30120RE	5,163	5,913	6,677	7,474	8,873	9,243	13,602	18,711
	36	60	1	VS3660RE	3,468	4,056	4,580	5,088	6,324	6,588	6,763	9,231
	36	72	1	VS3672RE	3,709	4,341	4,899	5,512	6,816	7,101	8,154	13,265
	36	84	1	VS3684RE	3,969	4,644	5,243	5,909	7,293	7,597	10,814	14,020
	36	96	1	VS3696RE	4,423	5,174	5,841	6,585	8,126	8,465	12,052	15,622
	36	120	1	VS36120RE	5,308	6,210	7,010	7,903	9,752	10,159	14,462	18,746
	42	60	1	VS4260RE	3,653	4,361	4,808	5,356	7,007	7,299	8,201	9,344
	42	72	1	VS4272RE	3,909	4,666	5,145	5,784	7,498	7,810	10,024	13,344
	42	84	1	VS4284RE	4,183	4,993	5,504	6,248	8,023	8,357	13,529	14,186
	42	96	1	VS4296RE	4,661	5,563	6,135	6,960	8,939	9,312	15,076	15,808
	42	120	1	VS42120RE	5,593	6,677	7,361	8,354	10,726	11,173	18,091	18,969

## How to Order

### Table Model Number

<b>VS</b> Base Series	<b>3684</b> Top Size	<b>RE</b> Top Shape	<b>LWFL</b> Top Material Edge Profile	<b>LDW</b> Top Finish	<b>WMW</b> Edge Finish	<b>MBM</b> Base Finish
--------------------------	-------------------------	------------------------	---	--------------------------	---------------------------	---------------------------

A VS3684RELWFLLDWWMWMBM is a Vista series 36" x 84" rectangle table with a black powder coat base and a laminate 1.25" thick top with a 1.25" flat wood edge profile.

The codes: LDW WMW specify a designer white laminate top, with a medium walnut edge.

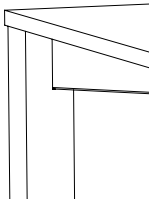

**Options**









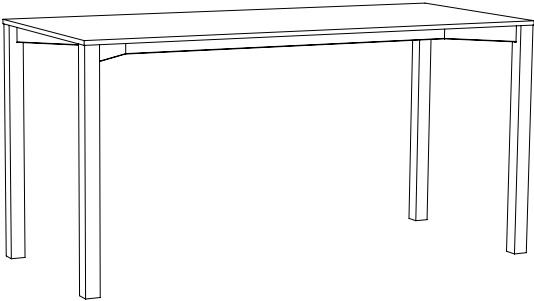

<b>Base Finishes</b>		
Custom Powder Coat (set-up charge)	CPC	📞
Stainless Steel	use finish code	2,426
<b>Base Options</b>		
Counter Height	CH	pages 122-123
Bar Height	BH	pages 122-123
Alternate Height	AH	📞
Locking Casters 3" Mag Wheel (qty 4)	MWC3	202
<b>Top Materials and Finishes</b>		
Any non-standard WCI Laminates (set-up charge)	use manufacturers finish code	173
Premium Laminates	PL	📞
Custom Wood Veneer	CWV	📞
Stain to Match (set-up charge)	STM	500

📞 Call for pricing



415.621.6656

# VISTA – Dining & Multipurpose - Counter & Bar Height



Laminate Surface	Wood Surface	Solid Surface	Quartz				
<b>Self Edge</b>  LLSE Self Edge	<b>Wood Edges Group A</b>  LWFL Flat   LWFP Flat Ply	<b>Wood Edges Group A</b>  WWFL Flat   WWFP Flat Ply	<b>Butcher Block</b>  BBFL Flat	<b>Corian® Group A</b>  C1FL Flat	<b>Corian® Group B</b>  C2FL Flat	<b>Quartz Group A</b>  Q1FL Flat	<b>Quartz Group B</b>  Q2FL Flat

## Complete Table List Pricing

	Top Size	Base Qty.	Model #								
Square 	36 36	1	VS3636SQ	3,353	3,762	4,184	4,791	5,634	5,869	5,468	7,340
	42 42	1	VS4242SQ	3,582	3,992	4,495	5,049	5,990	6,240	6,686	8,555
	48 48	1	VS4848SQ	4,342	4,853	5,479	6,168	7,326	7,631	8,214	10,550
Rectangle 	24 60	1	VS2460RE	3,177	3,569	3,968	4,252	5,056	5,266	5,563	7,560
	24 72	1	VS2472RE	3,608	4,063	4,525	4,854	5,779	6,020	6,381	8,703
	24 84	1	VS2484RE	4,025	4,542	5,064	5,439	6,479	6,749	7,173	9,807
	24 96	1	VS2496RE	4,430	5,006	5,590	6,004	7,158	7,457	7,942	10,881
	24 120	1	VS24120RE	5,220	5,910	6,611	7,111	8,484	8,837	9,442	12,974
	30 60	1	VS3060RE	3,850	4,341	4,839	5,194	6,186	6,443	6,841	9,345
	30 72	1	VS3072RE	4,087	4,611	5,145	5,625	6,645	6,922	8,147	13,347
	30 84	1	VS3084RE	4,339	4,901	5,472	6,067	7,166	7,465	10,615	14,410
	30 96	1	VS3096RE	4,781	5,407	6,041	6,706	7,925	8,256	11,778	16,008
	30 120	1	VS30120RE	5,641	6,391	7,155	7,951	9,404	9,796	14,044	19,128
	36 60	1	VS3660RE	3,945	4,535	5,057	5,566	6,855	7,140	7,205	9,647
	36 72	1	VS3672RE	4,188	4,819	5,377	5,991	7,347	7,653	8,597	13,682
	36 84	1	VS3684RE	4,447	5,121	5,720	6,387	7,824	8,150	11,257	14,436
	36 96	1	VS3096RE	4,901	5,653	6,320	7,064	8,657	9,017	12,495	16,037
	36 120	1	VS30120RE	5,786	6,687	7,488	8,380	10,283	10,711	14,904	19,162
	42 60	1	VS4260RE	4,132	4,839	5,285	5,834	7,539	7,853	8,644	9,760
	42 72	1	VS4272RE	4,387	5,145	5,623	6,263	8,028	8,363	10,467	13,760
	42 84	1	VS4284RE	4,662	5,472	5,983	6,725	8,554	8,910	13,972	14,602
	42 96	1	VS4296RE	5,138	6,041	6,612	7,439	9,471	9,866	15,518	16,224
42 120	1	VS42120RE	6,072	7,155	7,840	8,833	11,257	11,726	18,534	19,384	

## How to Order

Table Model Number						Options	
<b>VS</b> Base Series	<b>3684</b> Top Size	<b>RE</b> Top Shape	<b>LWFL</b> Top Material Edge Profile	<b>LDW</b> Top Finish	<b>WMW</b> Edge Finish	<b>MBM</b> Base Finish	<b>BH</b> Base Height

A VS3684RELWFLLDWWMWMBM-BH is a Vista series 36" x 84" rectangle table with a black powder coat base and a laminate 1.25" thick top with a 1.25" flat wood edge profile.

The codes: LDW WMW specify a designer white laminate top, with a medium walnut edge.

The code: BH specifies bar height base.

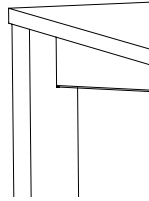

**Options**

**Base Finishes**

Custom Powder Coat (set-up charge)	CPC	📞
Stainless Steel	use finish code	2,426

**Base Options**

Alternate Height	AH	📞
Locking Casters 3" Mag Wheel (qty 4)	MWC3	202

**Top Materials and Finishes**

Any non-standard WCI Laminates (set-up charge)	use manufacturers finish code	173
Premium Laminates	PL	📞
Custom Wood Veneer	CWV	📞
Stain to Match (set-up charge)	STM	500

📞 Call for pricing

415.621.6656



# Occasional Tables

126	Blok
128	Brae
130	Cube
132	Cylinder
134	Disc
136	Kone
138	Move
140	Parsons
144	Platform
146	Triad

# BLOK – Occasional

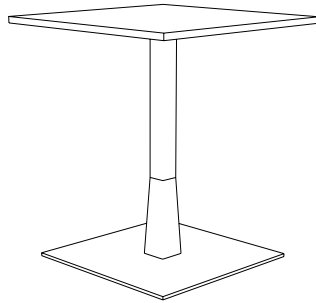

Laminate Surface		Wood Surface		Solid Surface											
Laminate		Veneer		Corian® Group A	Corian® Group B	Corian® Group A	Corian® Group B								
	LMFC Mini Facet Ply		LFCT Facet Ply		WMFC Mini Facet Ply		WFCT Facet Ply		C1FM Mini Facet		C2FM Mini Facet		C1FC Facet		C2FC Facet

## Complete Table List Pricing

	Top Size	Table Height	Base Qty.	Model #									
Square 	17 17	16	1	BL17SQ16	1,617	-	1,739	-	2,112	2,200	-	-	
		18	1	BL17SQ18	1,617	-	1,739	-	2,112	2,200	-	-	
		20	1	BL17SQ20	1,617	-	1,739	-	2,112	2,200	-	-	
	20 20	16	1	BL20SQ16	1,706	-	1,795	-	2,244	2,338	-	-	
		18	1	BL20SQ18	1,706	-	1,795	-	2,244	2,338	-	-	
		20	1	BL20SQ20	1,706	-	1,795	-	2,244	2,338	-	-	
	24 24	16	1	BL24SQ16	-	2,214	-	2,230	-	-	-	2,837	2,955
		18	1	BL24SQ18	-	2,214	-	2,230	-	-	-	2,837	2,955
		20	1	BL24SQ20	-	2,214	-	2,230	-	-	-	2,837	2,955
	30 30	16	1	BL30SQ16	-	2,405	-	2,405	-	-	-	3,283	3,420
		18	1	BL30SQ18	-	2,405	-	2,405	-	-	-	3,283	3,420
		20	1	BL30SQ20	-	2,405	-	2,405	-	-	-	3,283	3,420
36 36	16	1	BL36SQ16	-	2,837	-	2,898	-	-	-	4,145	4,318	
	18	1	BL36SQ18	-	2,837	-	2,898	-	-	-	4,145	4,318	
	20	1	BL36SQ20	-	2,837	-	2,898	-	-	-	4,145	4,318	
42 42	16	1	BL42SQ16	-	3,050	-	3,206	-	-	-	4,798	4,998	
	18	1	BL42SQ18	-	3,050	-	3,206	-	-	-	4,798	4,998	
	20	1	BL42SQ20	-	3,050	-	3,206	-	-	-	4,798	4,998	

## How to Order

### Table Model Number

<b>BL</b> Table Series	<b>1717</b> Top Size	<b>SQ</b> Top Shape	<b>18</b> Table Height	<b>WMFC</b> Top Material	<b>WNM</b> Top Finish	<b>MBM</b> Base Finish	<b>WNM</b> Wood Column Finish
---------------------------	-------------------------	------------------------	---------------------------	-----------------------------	--------------------------	---------------------------	----------------------------------

A BL1717SQ18WMFCWNM is a Blok series 17" x 17" square x 18" high occasional table with a black powder coat base and a wood veneer top .5" thick top with a .5" facet wood edge profile.

The code: WNM specifies a natural maple top.

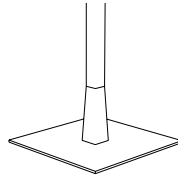

---

### Options

#### Base Finishes

Custom Powder Coat (set-up charge)	CPC	
Polished or Satin Chrome (per column)	use finish code	693
Premium Plated (per base)	use finish code	1,502
Stainless Steel Column and Base Cover (per base)	use finish code	1,733

#### Top Materials and Finishes

Any non-standard WCI Laminates (set-up charge)	use manufacturers finish code	173
Premium Laminates	PL	
Custom Wood Veneer	CWV	
Stain to Match (set-up charge)	STM	500

#### Top Options

Custom Size	CS	
-------------	----	--

Call for pricing

415.621.6656

# BRAE – Occasional

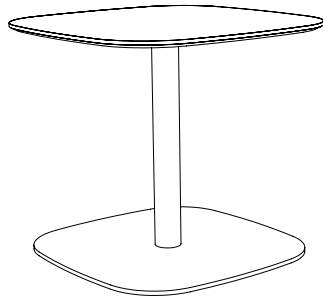

Laminate Surface		Wood Surface		Solid Surface			
LMFC Mini Facet Ply	LFCT Facet Ply	WMFC Mini Facet Ply	WFCT Facet Ply	C1FM Mini Facet	C2FM Mini Facet	C1FC Facet	C2FC Facet

## Complete Table List Pricing

	Top Size		Table Height	Base Qty.	Model #	Laminate		Wood		Solid Surface			
	Top Size	Top Size	Table Height	Base Qty.	Model #	LMFC	LFCT	WMFC	WFCT	C1FM	C2FM	C1FC	C2FC
RD Square 	20	20	16	1	BR2020RS16	1,369	-	1,385	-	1,892	1,970	-	-
	20	20	18	1	BR2020RS18	1,369	-	1,385	-	1,892	1,970	-	-
	20	20	20	1	BR2020RS20	1,369	-	1,385	-	1,892	1,970	-	-
	24	24	16	1	BR2424RS16	-	1,484	-	1,500	-	-	2,092	2,179
	24	24	18	1	BR2424RS18	-	1,484	-	1,500	-	-	2,092	2,179
	24	24	20	1	BR2424RS20	-	1,484	-	1,500	-	-	2,092	2,179
	30	30	16	1	BR3030RS16	-	1,677	-	1,694	-	-	2,571	2,679
	30	30	18	1	BR3030RS18	-	1,677	-	1,694	-	-	2,571	2,679
	36	36	16	1	BR3636RS16	-	2,170	-	2,233	-	-	3,540	3,688
	36	36	18	1	BR3636RS18	-	2,170	-	2,233	-	-	3,540	3,688
	42	42	16	1	BR4242RS16	-	2,388	-	2,549	-	-	4,244	4,421
	42	42	18	1	BR4242RS18	-	2,388	-	2,549	-	-	4,244	4,421

## How to Order

### Table Model Number

<b>BR</b> Table Series	<b>1717</b> Top Size	<b>RS</b> Top Shape	<b>18</b> Table Height	<b>WMFC</b> Top Material	<b>WNM</b> Top Finish	<b>MBM</b> Base Finish	<b>WNM</b> Wood Column Finish
---------------------------	-------------------------	------------------------	---------------------------	-----------------------------	--------------------------	---------------------------	----------------------------------

A BR1717RS18WMFCWNMMBMWNM is a Brae series 17" x 17" RD Square x 18" high occasional table with a black powder coat base and a wood veneer top .5" thick top with a .5" facet wood edge profile.

The code: WNM specifies a natural maple top.

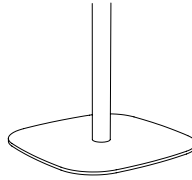

---

### Options

#### Base Finishes

Custom Powder Coat (set-up charge)	CPC	📞
Polished or Satin Chrome (per column)	use finish code	693
Premium Plated (per base)	use finish code	1,502
Stainless Steel Column and Base Cover (per base)	use finish code	1,733

#### Top Materials and Finishes

Any non-standard WCI Laminates (set-up charge)	use manufacturers finish code	173
Premium Laminates	PL	📞
Custom Wood Veneer	CWV	📞
Stain to Match (set-up charge)	STM	500

#### Top Options

Custom Size	CS	📞
-------------	----	---

📞 Call for pricing

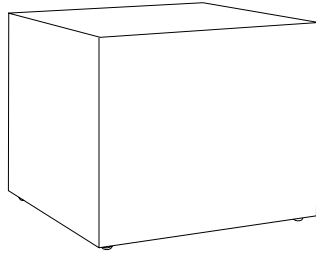

415.621.6656

# CUBE – Occasional



Laminate		Overlay		
LAM Laminate	OLC1LAM Corian® Top	OLC2LAM Corian® Top	Q1LAM Quartz Top	Q2LAM Quartz Top

## Complete Table List Pricing

	Top Size		Table Height	Model #					
Square 	18	18	18	CU1818SQ18	1,426	1,459	1,519	2,775	2,609
			20	CU1818SQ20	1,533	1,530	1,594	2,835	2,665
			24	CU1818SQ24	1,681	1,629	1,697	2,917	2,742
	20	20	18	CU2020SQ18	1,566	1,610	1,678	2,924	2,748
			20	CU2020SQ20	1,679	1,684	1,755	2,987	2,807
			24	CU2020SQ24	1,835	1,790	1,865	3,075	2,890
	24	24	18	CU2424SQ18	1,788	1,893	1,972	3,401	3,197
			20	CU2424SQ20	1,911	1,973	2,056	3,469	3,261
			24	CU2424SQ24	2,087	2,091	2,178	3,567	3,353
	30	30	16	CU3030SQ16	2,039	2,356	2,454	4,038	3,796
			18	CU3030SQ18	2,176	2,446	2,548	4,113	3,866
	36	36	16	CU3636SQ16	2,384	3,072	3,200	5,292	4,975
18			CU3636SQ18	2,532	3,171	3,303	5,374	5,051	
Rectangle 	20	30	18	CU2030RE18	1,826	1,936	2,017	3,919	3,684
			20	CU2030RE20	1,948	2,018	2,102	3,986	3,747
	24	36	16	CU2436RE16	2,026	2,303	2,399	5,092	4,786
			18	CU2436RE18	2,160	2,394	2,494	5,167	4,857
	24	48	16	CU2448RE16	2,323	2,785	2,901	5,825	5,475
			18	CU2448RE18	2,471	2,883	3,003	5,907	5,553

## How to Order

Table Model Number						Options		
CU Base Series	2020 Top Size	SQ Top Shape	18 Table Height	COVEN Material	CDW Designer White	WNM Natural Maple Veneer	KBL Laminate Kick Base	LJB Jett Black
<p>A CU2020SQ18COVENWNM is a cube occasional table, 20" x 20" square x 18" high with wood veneer base and corian top.</p>						<p>The code: CDW specifies Designer White corian top with wood natural maple veneer base.</p>		<p>The code: KBL specifies a 2" high x 1" deep laminate kick base.</p>
						<p>The code: LJB specifies the color of the laminate used on the kick base.</p>		

Wood	Overlay			
Veneer	Corian® Group A	Corian® Group B		
VEN Wood Veneer	OLC1VEN Corian® Top	OLC2VEN Corian® Top	Q1VEN Quartz Top	Q2VEN Quartz Top

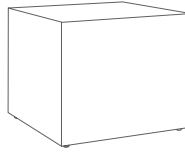

### Options

#### Base Options

Kick Base (laminated)	KBL	335
Kick Base (veneer)	KBV	434

#### Top Materials and Finishes

Any non-standard WCI Laminates (set-up charge)	use manufacturers finish code	173
Standard Wood Veneer	use wood surface code	n/c
Premium Laminates	PL	🔒
Custom Wood Veneer	CWV	🔒
Custom Top Material	NSF	🔒
Special Pattern Veneer	SPV	🔒
Stain to Match (set-up charge)	STM	500

2,196	1,972	2,054	3,203	3,011
2,327	2,059	2,145	3,276	3,079
2,513	2,183	2,274	3,379	3,176
2,313	2,050	2,135	3,340	3,139
2,447	2,141	2,230	3,414	3,210
2,647	2,273	2,368	3,526	3,314
2,515	2,185	2,276	3,806	3,578
2,657	2,280	2,375	3,885	3,652
2,869	2,421	2,522	4,003	3,763
3,029	2,528	2,633	4,588	4,313
3,208	2,647	2,757	4,687	4,406
3,320	2,722	2,835	5,811	5,463
3,447	2,806	2,923	5,883	5,530
2,647	2,273	2,368	4,375	4,112
2,816	2,385	2,485	4,468	4,200
2,861	2,416	2,516	5,557	5,224
3,043	2,537	2,643	5,657	5,318
3,257	2,680	2,791	6,343	5,962
3,453	2,810	2,927	6,453	6,065

🔒 Call for pricing

415.621.6656

# CYLINDER – Occasional

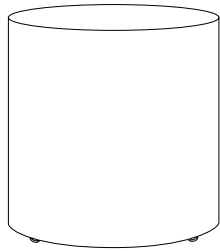

Laminate		Overlay		
Laminate	Corian® Group A	Corian® Group B	Quartz Group B	Quartz Group A
LAM Laminate	OLC1LAM Corian® Top	OLC2LAM Corian® Top	Q1LAM Quartz Top	Q2LAM Quartz Top

## Complete Table List Pricing

	Top Size	Table Height	Model #	LAM	OLC1LAM	OLC2LAM	Q1LAM	Q2LAM
Round 	18	18	CY18RD18	1,543	1,577	1,643	2,679	2,518
		20	CY18RD20	1,825	1,836	1,913	3,058	2,875
		24	CY18RD24	1,992	1,954	2,035	3,155	2,966
	20	18	CY20RD18	1,814	1,885	1,964	3,121	2,933
		20	CY20RD20	1,920	1,960	2,042	3,183	2,992
		24	CY20RD24	2,098	2,086	2,173	3,288	3,091
	24	18	CY24RD18	1,926	2,103	2,190	3,542	3,329
		20	CY24RD20	2,040	2,185	2,276	3,609	3,393
		24	CY24RD24	2,235	2,322	2,419	3,724	3,500
	30	16	CY30RD16	2,381	2,723	2,837	4,304	4,046
		18	CY30RD18	2,532	2,833	2,951	4,393	4,130
		20	CY30RD20	2,685	2,940	3,062	4,485	4,216
24		CY30RD24	2,958	3,131	3,262	4,644	4,366	
36	18	CY36RD18	2,760	3,513	3,659	5,590	5,255	
	20	CY36RD20	2,934	3,635	3,787	5,693	5,351	
	24	CY36RD24	3,250	3,860	4,021	5,878	5,526	

## How to Order

Table Model Number							Options	
CY Base Series	24 Top Size	RD Top Shape	18 Table Height	COVEN Material	CDW Designer White	WNM Base Material	KBL Laminate Kick Base	LJB Jett Black
<p>A CY24RD18CVENCDWWNM is a cylinder occasional table, 24" round x 18" high in wood veneer with corian top.</p>							<p>The code: CDW specifies Designer White corian top with wood natural maple veneer base.</p>	
							<p>The code: KB specifies a 2" high x 1" deep laminate kick base.</p>	
							<p>The code: LJB specifies the color of the laminate used on the kick base.</p>	

Wood	Overlay			
Veneer	Corian® Group A	Corian® Group B		
VEN Wood Veneer	OLC1VEN Corian® Top	OLC2VEN Corian® Top	Q1VEN Quartz Top	Q2VEN Quartz Top

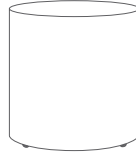

**Options**

**Base Options**

Kick Base (laminated)	KBL	335
Kick Base (veneer)	KBV	434

**Top Materials and Finishes**

Any non-standard WCI Laminates (set-up charge)	use manufacturers finish code	173
Standard Wood Veneer	use wood surface code	n/c
Premium Laminates	PL	📞
Custom Wood Veneer	CWV	📞
Custom Top Material	NSF	📞
Special Pattern Veneer	SPV	📞
Stain to Match (set-up charge)	STM	500







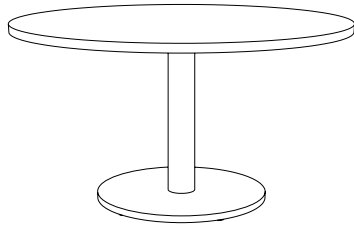

1,818	1,770	1,844	2,840	2,670
2,151	2,066	2,152	3,248	3,053
2,323	2,185	2,276	3,350	3,149
2,141	2,117	2,206	3,314	3,115
2,265	2,203	2,295	3,386	3,183
2,442	2,327	2,424	3,491	3,282
2,324	2,384	2,483	3,776	3,550
2,452	2,474	2,577	3,851	3,620
2,640	2,608	2,717	3,961	3,723
2,803	3,023	3,149	4,554	4,281
2,966	3,136	3,267	4,649	4,370
3,127	3,251	3,387	4,743	4,459
3,381	3,431	3,574	4,894	4,600
3,179	3,808	3,967	5,838	5,487
3,355	3,934	4,098	5,941	5,585
3,647	4,138	4,311	6,112	5,745

📞 Call for pricing

415.621.6656

# DISC – Occasional



Laminate Surface	Wood Surface	Solid Surface
 Laminate LMFC Mini Facet Ply	 Veneer WMFC Mini Facet Ply	 Corian® Group A C1FM Mini Facet
 LFCT Facet Ply	 WFCT Facet Ply	 Corian® Group B C2FM Mini Facet
		 Corian® Group A C1FC Facet
		 Corian® Group B C2FC Facet

## Complete Table List Pricing

	Top Size	Table Height	Base Qty.	Model #								
Round  	20	16	1	DI20RD16	1,356	-	1,372	-	1,892	1,970	-	-
	20	18	1	DI20RD18	1,356	-	1,372	-	1,892	1,970	-	-
	20	20	1	DI20RD20	1,356	-	1,372	-	1,892	1,970	-	-
	24	16	1	DI24RD16	-	1,469	-	1,487	-	-	2,092	2,179
	24	18	1	DI24RD18	-	1,469	-	1,487	-	-	2,092	2,179
	24	20	1	DI24RD20	-	1,469	-	1,487	-	-	2,092	2,179
	30	16	1	DI30RD16	-	1,662	-	1,678	-	-	2,571	2,679
	30	18	1	DI30RD18	-	1,662	-	1,678	-	-	2,571	2,679
	36	16	1	DI36RD16	-	2,150	-	2,213	-	-	3,540	3,688
	36	18	1	DI36RD18	-	2,150	-	2,213	-	-	3,540	3,688
	42	16	1	DI42RD16	-	2,366	-	2,526	-	-	4,244	4,421
	42	18	1	DI42RD18	-	2,366	-	2,526	-	-	4,244	4,421

## How to Order

### Table Model Number

DI Table Series	17 Top Size	RD Top Shape	18 Table Height	WMFC Top Material	WNM Top Finish	MBM Base Finish	WNM Wood Column Finish
--------------------	----------------	-----------------	--------------------	----------------------	-------------------	--------------------	---------------------------

A DI17RD18WMFCWNMMBMBWNM is a Kone series 17" round x 18" high occasional table with a black powder coat base and a wood veneer top .5" thick top with a .5" facet wood edge profile.

The code: WNM specifies a natural maple top.

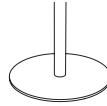

---

### Options

---

**Base Finishes**

Custom Powder Coat (set-up charge)	CPC	📞
Polished or Satin Chrome (per column)	use finish code	693
Premium Plated (per base)	use finish code	1,502
Stainless Steel Column and Base Cover (per base)	use finish code	1,733

**Top Materials and Finishes**

Any non-standard WCI Laminates (set-up charge)	use manufacturers finish code	173
Premium Laminates	PL	📞
Custom Wood Veneer	CWV	📞
Stain to Match (set-up charge)	STM	500

**Top Options**

Custom Size	CS	📞
-------------	----	---

📞 Call for pricing

415.621.6656

# KONE – Occasional

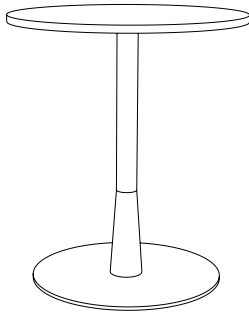

Laminate Surface		Wood Surface		Solid Surface			
Laminate	Veneer	Corian® Group A	Corian® Group B	Corian® Group A	Corian® Group B	Corian® Group A	Corian® Group B
LMFC Mini Facet Ply	LFCT Facet Ply	WMFC Mini Facet Ply	WFCT Facet Ply	C1FM Mini Facet	C2FM Mini Facet	C1FC Facet	C2FC Facet

## Complete Table List Pricing

Round	Top Size	Table Height	Base Qty.	Model #	LMFC	LFCT	WMFC	WFCT	C1FM	C2FM	C1FC	C2FC
	17	16	1	KO17RD16	1,588	-	1,709	-	2,096	2,184	-	-
		18	1	KO17RD18	1,588	-	1,709	-	2,096	2,184	-	-
		20	1	KO17RD20	1,588	-	1,709	-	2,096	2,184	-	-
	20	16	1	KO20RD16	1,676	-	1,764	-	2,228	2,321	-	-
		18	1	KO20RD18	1,676	-	1,764	-	2,228	2,321	-	-
		20	1	KO20RD20	1,676	-	1,764	-	2,228	2,321	-	-
	24	16	1	KO24RD16	-	2,185	-	2,200	-	-	2,977	3,101
		18	1	KO24RD18	-	2,185	-	2,200	-	-	2,977	3,101
		20	1	KO24RD20	-	2,185	-	2,200	-	-	2,977	3,101
30	16	1	KO30RD16	-	2,373	-	2,373	-	-	3,458	3,603	
	18	1	KO30RD18	-	2,373	-	2,373	-	-	3,458	3,603	
	20	1	KO30RD20	-	2,373	-	2,373	-	-	3,458	3,603	
36	16	1	KO36RD16	-	2,852	-	2,894	-	-	4,378	4,561	
	18	1	KO36RD18	-	2,852	-	2,894	-	-	4,378	4,561	
	20	1	KO36RD20	-	2,852	-	2,894	-	-	4,378	4,561	
42	16	1	KO42RD16	-	3,045	-	3,200	-	-	5,073	5,284	
	18	1	KO42RD18	-	3,045	-	3,200	-	-	5,073	5,284	
	20	1	KO42RD20	-	3,045	-	3,200	-	-	5,073	5,284	

## How to Order

### Table Model Number

KO	17	RD	18	WMFC	WNM	MBM	WNM
Table Series	Top Size	Top Shape	Table Height	Top Material	Top Finish	Base Finish	Wood Column Finish

A KO17RD18WMFCWNMMBMWNM is a Kone series 17" round x 18" high occasional table with a black powder coat base and a wood veneer top .5" thick top with a .5" facet wood edge profile.

The code: WNM specifies a natural maple top.

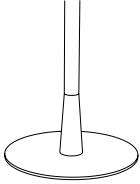

---

**Options**

---

<b>Base Finishes</b>		
Custom Powder Coat (set-up charge)	CPC	📞
Polished or Satin Chrome (per column)	use finish code	693
Premium Plated (per base)	use finish code	1,502
Stainless Steel Column and Base Cover (per base)	use finish code	1,733

---

<b>Top Materials and Finishes</b>		
Any non-standard WCI Laminates (set-up charge)	use manufacturers finish code	173
Premium Laminates	PL	📞
Custom Wood Veneer	CWV	📞
Stain to Match (set-up charge)	STM	500

---



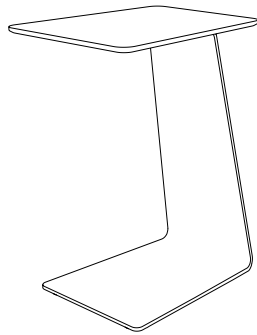

<b>Top Options</b>		
Custom Size	CS	📞

📞 Call for pricing 415.621.6656

# MOVE – Occasional



## Laminate Wood Solid Surface

Laminate	Wood	Solid Surface	
Laminate	Veneer	Corian® Group A	Corian® Group B
			
LMOV Ply	WMOV Wood	C1MOV	C2MOV

## Complete Table List Pricing

	Top Size		Table Height		Model #				
	18	13	15	25					
Trapezoid					MOV	1,260	1,392	1,490	1,552
									

## How to Order

### Table Model Number

MOV	WMOV	WNM	MBM
Table Series	Top Material	Top Finish	Base Finish

A MOVWMOVWNMBM is a Move table with a matte black powder coat base and a wood veneer top.

The code: WNM specifies a natural maple top.

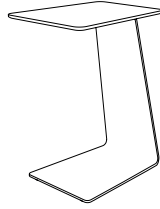

### Options

#### Base Finishes

Custom Powder Coat (set-up charge)	CPC	📞
Satin Chrome (per base)	use finish code	523
Premium Plated (per base)*	use finish code	1,502

\*Premium plated polished not available on Move tables.

#### Top Materials and Finishes

Any non-standard WCI Laminates (set-up charge)	use manufacturers finish code	173
Premium Laminates	PL	📞
Custom Wood Veneer	CWV	📞
Stain to Match (set-up charge)	STM	500

#### Top Options

Handle**	HAN	104
Cup holder Left	CHL	104
Cup Holder Right	CHR	104
Bag Hook Left	BHL	75
Bag Hook Right	BHR	75

\*\*Handle available for Corian®.

📞 Call for pricing

415.621.6656

# PARSONS – Occasional

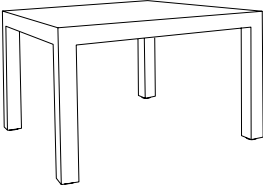
	Laminate	Wood
	Laminate LAM Laminate	Veneer VEN Wood Veneer

## Complete Table List Pricing

	Top Size		Table Height	Model #		
Square 	18	18	18	PA1818SQ18	1,963	2,831
			20	PA1818SQ20	2,004	2,874
			24	PA1818SQ24	2,086	2,957
	20	20	18	PA2020SQ18	2,002	2,886
			20	PA2020SQ20	2,043	2,928
			24	PA2020SQ24	2,127	3,011
	24	24	18	PA2424SQ18	2,351	3,303
			20	PA2424SQ20	2,392	3,345
			24	PA2424SQ24	2,474	3,429
	30	30	16	PA3030SQ16	2,526	3,612
			18	PA3030SQ18	2,599	3,718
			20	PA3030SQ20	2,640	3,761
24			PA3030SQ24	2,723	3,845	
36	36	16	PA3636SQ16	2,780	3,959	
		18	PA3636SQ18	2,851	4,066	
		20	PA3636SQ20	2,893	4,108	
		24	PA3636SQ24	2,975	4,192	

Continued on next page

## How to Order

### Table Model Number

PA	1818	SQ	18	VEN	WNM
Base Series	Top Size	Top Shape	Table Height	Material	Wood Natural Maple Veneer

A PA1818SQ18VENWNM is a Parsons series 18" x 18" square x 18" high occasional table, with four with wood veneer legs.

The code: WNM specifies wood natural maple veneer.

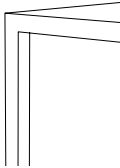

---

**Options**

---

**Top Materials and Finishes**

Any non-standard WCI Laminates (set-up charge)	use manufacturers finish code	173
Premium Laminates	PL	📞
Custom Wood Veneer	CWV	📞
Special Pattern Veneer	SPV	📞
Stain to Match (set-up charge)	STM	500

---

📞 Call for pricing

415.621.6656

# PARSONS – Occasional

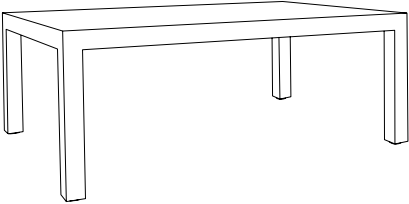
	Laminate	Wood
	Laminate LAM Laminate	Veneer VEN Wood Veneer

## Complete Table List Pricing

	Top Size	Table Height	Model #	Laminate	Wood		
Rectangle 	18	36	16	PA1836RE16	2,195	3,258	
		18	18	PA1836RE18	2,268	3,365	
		20	16	PA1836RE20	2,309	3,406	
	18	48	16	16	PA1848RE16	2,437	3,589
			18	18	PA1848RE18	2,509	3,696
			20	16	PA1848RE20	2,550	3,738
	18	60	16	16	PA1860RE16	2,664	3,912
			18	18	PA1860RE18	2,735	4,019
			20	16	PA1860RE20	2,777	4,062
	20	30	16	16	PA2030RE16	2,163	3,217
			18	18	PA2030RE18	2,236	3,324
			20	16	PA2030RE20	2,277	3,676
24	36	16	16	PA2436RE16	2,410	3,563	
		18	18	PA2436RE18	2,483	3,701	
24	48	16	16	PA2448RE16	2,631	3,890	
		18	18	PA2448RE18	2,702	3,997	

## How to Order

### Table Model Number

PA	1860	RE	18	VEN	WNM
Base Series	Top Size	Top Shape	Table Height	Material	Wood Natural Maple Veneer

A PA1860RE18VENWNM is a Parsons series 18" x 60" rectangle x 18" high occasional table, with four wood veneer legs.

The code: WNM specifies wood natural maple veneer.

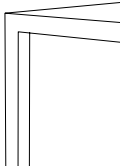

---

**Options**

---

<b>Top Materials and Finishes</b>		
Any non-standard WCI Laminates (set-up charge)	use manufacturers finish code	173
Premium Laminates	PL	📞
Custom Wood Veneer	CWV	📞
Special Pattern Veneer	SPV	📞
Stain to Match (set-up charge)	STM	500

---

📞 Call for pricing

415.621.6656

# PLATFORM – Occasional

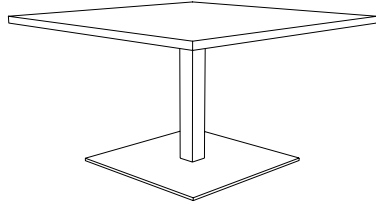

Laminate Surface		Wood Surface		Solid Surface			
Laminate		Veneer		Corian® Group A	Corian® Group B	Corian® Group A	Corian® Group B
	LMFC Mini Facet Ply		LFCT Facet Ply		WMFC Mini Facet Ply		WFCT Facet Ply
	C1FM Mini Facet		C2FM Mini Facet		C1FC Facet		C2FC Facet

## Complete Table List Pricing

	Top Size		Table Height	Base Qty.	Model #								
Square 	20	20	16	1	PL2020SQ16	1,067	1,369	1,614	1,348	1,873	1,951	-	-
			18	1	PL2020SQ18	1,067	1,369	1,614	1,348	1,873	1,951	-	-
			20	1	PL2020SQ20	1,067	1,369	1,614	1,348	1,873	1,951	-	-
	24	24	16	1	PL2424SQ16	1,126	1,483	1,772	1,499	2,108	2,196	2,418	3,224
			18	1	PL2424SQ18	1,126	1,483	1,772	1,499	2,108	2,196	2,418	3,224
			20	1	PL2424SQ20	1,126	1,483	1,772	1,499	2,108	2,196	2,418	3,224
	30	30	16	1	PL3030SQ16	1,230	1,677	1,988	1,677	2,375	2,474	3,299	4,398
			18	1	PL3030SQ18	1,230	1,677	1,988	1,677	2,375	2,474	3,299	4,398
	36	36	16	1	PL3636SQ16	1,661	2,170	2,548	2,233	3,032	3,158	4,512	6,016
			18	1	PL3636SQ18	1,661	2,170	2,548	2,233	3,032	3,158	4,512	6,016
	42	42	16	1	PL4242SQ16	1,813	2,388	2,831	2,548	3,386	3,527	5,759	7,679
			18	1	PL4242SQ18	1,813	2,388	2,831	2,548	3,386	3,527	5,759	7,679
Rectangle 	20	30	16	1	PL2030RE16	1,116	1,390	1,805	1,466	2,148	2,237	-	-
			18	1	PL2030RE18	1,116	1,390	1,805	1,466	2,148	2,237	-	-
	20	36	16	1	PL2036RE16	1,143	1,454	1,889	1,536	2,252	2,346	-	-
			18	1	PL2036RE18	1,143	1,454	1,889	1,536	2,252	2,346	-	-
	30	36	16	1	PL3036RE16	1,597	2,081	2,421	2,206	2,875	2,995	4,113	5,484
			18	1	PL3036RE18	1,597	2,081	2,421	2,206	2,875	2,995	4,113	5,484
	30	42	16	1	PL3042RE16	1,658	2,244	2,627	2,387	3,130	3,260	4,578	6,104
			18	1	PL3042RE18	1,658	2,244	2,627	2,387	3,130	3,260	4,578	6,104
	30	48	16	1	PL3048RE16	1,951	2,552	2,966	2,707	3,524	3,671	5,309	7,079
			18	1	PL3048RE18	1,951	2,552	2,966	2,707	3,524	3,671	5,309	7,079

## How to Order

### Table Model Number

PL	1717	SQ	18	WMFC	WNN	MBM	WNN
Table Series	Top Size	Top Shape	Table Height	Top Material	Top Finish	Base Finish	Wood Column Finish

A PL1717SQ18WMFCWNNMBMWNN is a Blok series 17" x 17" square x 18" high occasional table with a black powder coat base and a wood veneer top .5" thick top with a .5" facet wood edge profile.

The code: WNN specifies a natural maple top.

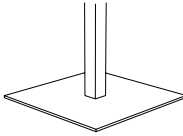

**Options**

<b>Base Finishes</b>		
Custom Powder Coat (set-up charge)	CPC	📞
Polished or Satin Chrome (per column)	use finish code	693
Premium Plated (per base)	use finish code	1,502
Stainless Steel Column and Base Cover (per base)	use finish code	1,733

<b>Top Materials and Finishes</b>		
Any non-standard WCI Laminates (set-up charge)	use manufacturers finish code	173
Premium Laminates	PL	📞
Custom Wood Veneer	CWV	📞
Stain to Match (set-up charge)	STM	500



<b>Top Options</b>		
Custom Size	CS	📞

📞 Call for pricing 415.621.6656

# TRIAD – Occasional

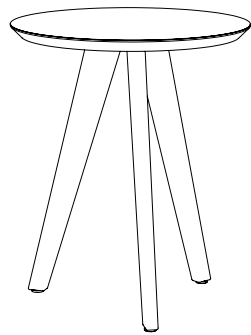

## Wood    Solid Surface

Wood	Solid Surface	
Veneer	Corian® Group A	Corian® Group B
		
WWTR Prism	C1PR Prism	C2PR Prism

## Complete Table List Pricing

	Top Size	Table Height	Base Qty.	Model #			
Round 	20	18	1	TR20RD18	1,774	2,166	2,256
		20	1	TR20RD20	1,851	2,499	2,603
	24	16	1	TR24RD16	1,928	2,582	2,690
		18	1	TR24RD18	2,006	2,666	2,778
		20	1	TR24RD20	2,082	2,750	2,864
	30	16	1	TR30RD16	2,315	2,916	3,037
	36	16	1	TR36RD16	2,562	3,264	3,400

## How to Order

### Table Model Number

<b>TR</b>	<b>20RD</b>	<b>18</b>	<b>WTTR</b>	<b>WNA</b>
Table Series	Top Size	Table Height	Top Material	Top Finish

A TR20RD18WWTRWNAWNA is a 20" round x 18"H Triad occasional table with a wood veneer top and base.

The code: WNA specifies a natural Ash top.

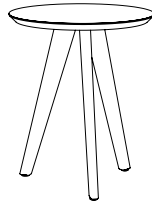

---

### Options

---

#### Top Materials and Finishes

Custom Wood Veneer	CWV	📞
Custom Top Pattern	NSF	📞
Stain to Match (set-up charge)	STM	500

---

📞 Call for pricing

415.621.6656



# Outdoor Tables

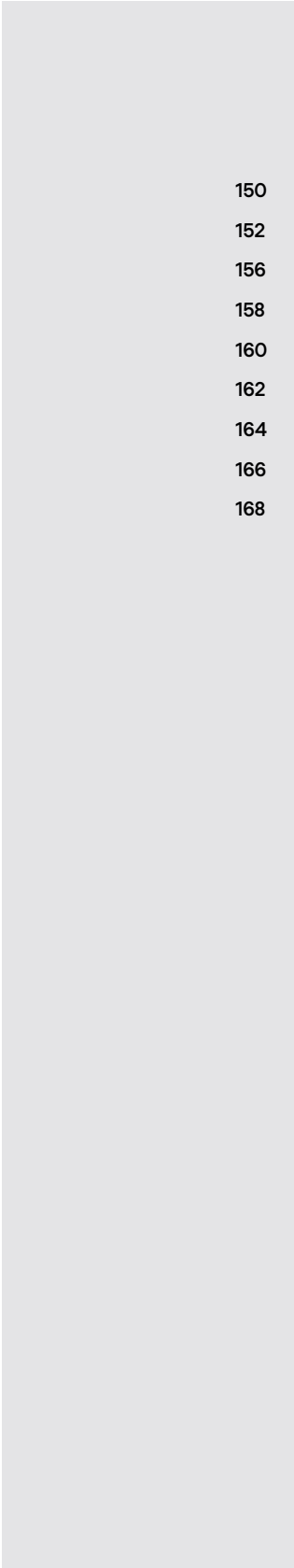

- 150 Basic Round
- 152 Brae
- 156 Brae Double
- 158 Disc
- 160 Flat Round
- 162 Platform
- 164 Platform Double
- 166 Tulip
- 168 Vista

# BASIC ROUND – Outdoor

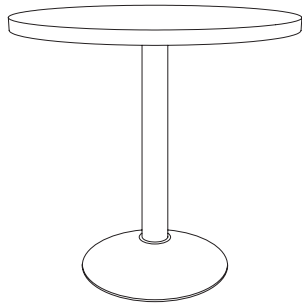

## Metal Surface      Solid Surface

Metal Surface		Solid Surface	
Metal Solid	Metal Mesh	Corian*	Corian*
MES Solid	MEM Mesh	C1FL Flat	C2FL Flat
		C1BN Bullnose	C2BN Bullnose
		C1PR Prism	C2PR Prism

## Complete Table List Pricing

	Top Size	Base Qty.	Base Style	Model #				
Round 	24	1	17L	BA24RDOD	-	-	1,773	1,847
	30	1	17M	BA30RDOD	1,498	-	2,360	2,459
	36	1	20M	BA36RDOD	1,722	-	3,086	3,215
	42	1	22L	BA42RDOD	1,906	-	3,824	3,983
	48	1	22M	BA48RDOD	2,155	-	4,747	4,945
	54	1	22M	BA54RDOD	-	-	5,746	5,985
	60	1	28H	BA60RDOD	-	-	7,077	7,371
Square 	24 24	1	17L	BA2424SQOD	-	-	1,612	1,679
	30 30	1	17M	BA3030SQOD	1,494	-	2,157	2,247
	36 36	1	20M	BA3636SQOD	1,689	-	2,862	2,981
	42 42	1	22M	BA4242SQOD	1,970	-	3,630	3,781
	48 48	1	22M	BA4848SQOD	-	-	4,528	4,716
Rectangle 	24 30	1	17M	BA2430REOD	1,369	-	1,899	1,979
	24 36	1	20M	BA2436REOD	-	-	2,178	2,269
	24 60	2	17L	BA2460REOD	-	-	3,357	3,497
	30 36	1	20M	BA3036REOD	-	-	2,490	2,593
	30 42	1	22L	BA3042REOD	-	-	2,743	2,857
	30 48	1	22M	BA3048REOD	1,860	-	3,107	3,237
	30 60	2	17M	BA3060REOD	-	-	4,002	4,169

## How to Order

### Table Model Number

**BA** Base Series      **36** Top Size      **RD** Top Shape      **OD** Outdoor      **MES** Top Material      **MSL** Top Finish      **MBM** Base Finish

A BA36RDODMESMSLMBM is an outdoor Basic Round series 36" round table with a black powder coat round base and a solid metal .75" thick top with a metal eased edge profile.

The code: MSL specifies a silver powder coat top.

### Options

**AH** Alternate Height Base

The code: AH specifies alternate height base

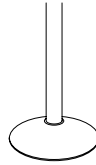

### Options

#### Base Finishes

Standard Black Texture	MBT	n/c
Powder Coat	use finish code	134
Custom Powder Coat (set-up charge)	CPC	📞

#### Base Options

Counter, Bar, & Alternate Height (per column)	CH, BH, AH	80
Super Level Glides (per base)	GSL	n/c
Custom Top Plate Size	CTPS	📞
6" Column (black texture & powder coat)	COL6	235

#### Top Options

3" Radius Corner (per corner) (Corian®)	CRL3	42
Custom Radius Corner	CRC	100
Custom Size	CS	📞
Custom Shape	CSH	📞
2" Umbrella Hole	UMB	300

📞 Call for pricing

415.621.6656

# BRAE – Outdoor

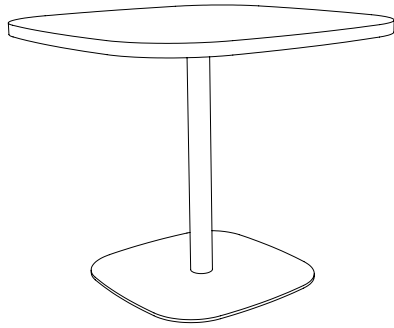

## Metal Surface      Solid Surface

Metal Surface		Solid Surface	
Metal Solid	Metal Mesh	Corian®	Corian®
MES Solid	MEM Mesh	C1FL Flat	C2FL Flat
		C1BN Bullnose	C2BN Bullnose
		C1PR Prism	C2PR Prism

## Complete Table List Pricing

	Top Size	Base Qty.	Model #				
<b>Round</b>  	30	1	BR3ORDOD	1,960	-	2,904	3,025
	36	1	BR36RDOD	2,433	-	3,910	4,073
	42	1	BR42RDOD	2,622	-	4,658	4,852
	48	1	BR48RDOD	3,040	-	5,772	6,013
<b>RD Square</b>  	30 30	1	BR3030RSOD	-	-	2,702	2,815
	36 36	1	BR3636RSOD	-	-	3,685	3,839
	42 42	1	BR4242RSOD	-	-	4,390	4,573
	48 48	1	BR4848RSOD	-	-	5,481	5,709
<b>Square</b>  	30 30	1	BR3030SQOD	1,957	-	2,702	2,815
	36 36	1	BR3636SQOD	2,401	-	3,685	3,839
	42 42	1	BR4242SQOD	2,617	-	4,390	4,573
	48 48	1	BR4848SQOD	-	-	5,481	5,709

Continued on next page

## How to Order

Table Model Number							Options
<b>BR</b> Base Series	<b>36</b> Top Size	<b>RD</b> Top Shape	<b>OD</b> Outdoor	<b>MES</b> Top Material	<b>MBM</b> Top Finish	<b>MSL</b> Base Finish	<b>AH</b> Alternate Height Base
A BR36RDODMESMBMMSL is an outdoor Brae series 36" round table with a silver powder coat base and a metal .75" thick top with a metal eased edge profile.					The code: MBM specifies a black matte powder coat top.		The code: AH specifies alternate height base

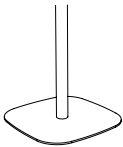

---

**Options**

---

**Base Finishes**

Custom Powder Coat (set-up charge)	CPC	📞
Stainless Steel (per base)	use finish code	1,733

---

**Base Options**

Counter, Bar, & Alternate Height (per column)	CH, BH, AH	80
Custom Top Plate Size	CTPS	📞
6" Column (powder coat)	COL6	📞

---

**Top Options**







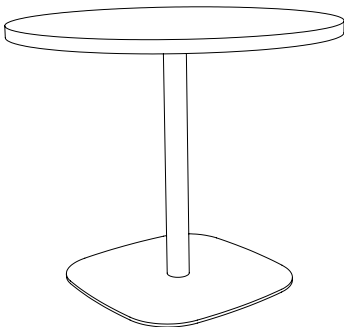

3" Radius Corner (per corner)	CRL3	42
(Corian®) Custom Size	CS	📞
Custom Radius Corner	CRC	100
Custom Shape	CSH	📞
Standard Powder Coat	use finish code	n/c
2" Umbrella Hole	UMB	300

---



📞 Call for pricing

415.621.6656

# BRAE – Outdoor

	Metal Surface		Solid Surface	
	<b>Metal Solid</b>  <b>MES</b> Solid	<b>Metal Mesh</b>  <b>MEM</b> Mesh	<b>Corian®</b>  <b>C1FL</b> Flat	<b>Corian®</b>  <b>C2FL</b> Flat
			 <b>C1BN</b> Bullnose	 <b>C2BN</b> Bullnose
			 <b>C1PR</b> Prism	 <b>C2PR</b> Prism

## Complete Table List Pricing

	Top Size		Base Qty.	Model #				
Rectangle 	24	30	1	BR2430REOD	1,833	-	2,442	2,544
	24	36	1	BR2436REOD	-	-	3,003	3,128
	24	42	1	BR2442REOD	-	-	3,216	3,350
	24	48	1	BR2448REOD	-	-	3,431	3,574
	24	60	2	BR2460REOD	-	-	4,576	4,767
	24	72	2	BR2472REOD	-	-	5,032	5,242
	30	36	1	BR3036REOD	-	-	3,313	3,451
	30	42	1	BR3042REOD	-	-	3,576	3,725
	30	48	1	BR3048REOD	2,750	-	4,136	4,308
	30	60	2	BR3060REOD	-	-	5,090	5,302
RD Rectangle 	30	48	1	BR3048RRD	-	-	4,136	4,308
	30	60	2	BR3060RRD	-	-	5,090	5,302

## How to Order

Table Model Number							Options
<b>BR</b> Base Series	<b>36</b> Top Size	<b>RD</b> Top Shape	<b>OD</b> Outdoor	<b>MES</b> Top Material	<b>MBM</b> Top Finish	<b>MSL</b> Base Finish	<b>AH</b> Alternate Height Base
A BR36RDODMESMBMMSL is an outdoor Brae series 36" round table with a silver powder coat base and a metal .75" thick top with a metal eased edge profile.					The code: MBM specifies a black matte powder coat top.		The code: AH specifies alternate height base

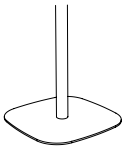

**Options**

<b>Base Finishes</b>		
Custom Powder Coat (set-up charge)	CPC	📞
Stainless Steel (per base)	use finish code	1,733
<b>Base Options</b>		
Counter, Bar, & Alternate Height (per column)	CH, BH, AH	80
Custom Top Plate Size	CTPS	📞
6" Column (powder coat)	COL6	📞
<b>Top Options</b>		
3" Radius Corner (per corner)	CRL3	42
(Corian®) Custom Size	CS	📞
Custom Radius Corner	CRC	100
Custom Shape	CSH	📞
Standard Powder Coat	use finish code	n/c
2" Umbrella Hole	UMB	300







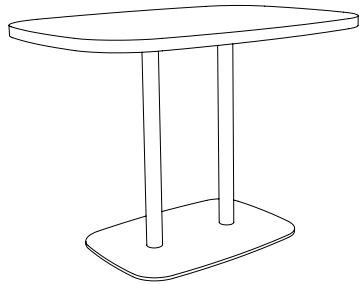

📞 Call for pricing

415.621.6656



# BRAE DOUBLE – Outdoor



## Metal Surface      Solid Surface

Metal Surface		Solid Surface	
Metal Solid	Metal Mesh	Corian®	Corian®
 MES Solid	 MEM Mesh	 C1FL Flat	 C2FL Flat
		 C1BN Bullnose	 C2BN Bullnose
		 C1PR Prism	 C2PR Prism

## Complete Table List Pricing

	Top Size		Base Qty.	Model #				
Rectangle	30	42	1	BRD3042REOD	-	-	3,988	4,154
	30	48	1	BRD3048REOD	2,880	-	4,279	4,458
								
RD Rectangle	30	42	1	BRD3042RRD	-	-	3,988	4,154
	30	48	1	BRD3048RRD	-	-	4,279	4,458
								

## How to Order

### Table Model Number

<b>BRD</b> Base Series	<b>3048</b> Top Size	<b>RE</b> Top Shape	<b>OD</b> Outdoor	<b>MES</b> Top Material	<b>MBM</b> Top Finish	<b>MSL</b> Base Finish
---------------------------	-------------------------	------------------------	----------------------	----------------------------	--------------------------	---------------------------

### Options

**AH**  
Alternate  
Height Base

A BRD3048REODMESMBMMSL is a Brae Double series 30" x 48" rectangle table with a silver powder coat base and a solid metal .75" thick top with a metal eased edge profile.

The code: MBM specifies a black matte powder coat top.

The code: AH specifies alternate height base

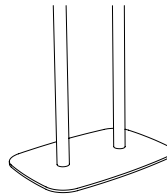

Double Column Base

### Options

#### Base Finishes

Custom Powder Coat (set-up charge)	CPC	📞
Stainless Steel (per base)	use finish code	1,733

#### Base Options

Counter, Bar, & Alternate Height (per column)	CH, BH, AH	80
Custom Top Plate Size	CTPS	📞
6" Column (powder coat)	COL6	📞

#### Top Options

3" Radius Corner (per corner)	CRL3	42
(Corian®) Custom Size	CS	📞
Custom Radius Corner	CRC	100
Custom Size	CS	📞
Custom Shape	CSH	📞
2" Umbrella Hole	UMB	300

📞 Call for pricing

415.621.6656

# DISC – Outdoor

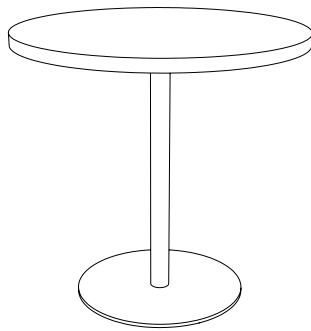

## Metal Surface      Solid Surface

Metal Surface		Solid Surface	
Metal Solid	Metal Mesh	Corian®	Corian®
MES Solid	MEM Mesh	C1FL Flat	C2FL Flat
		C1BN Bullnose	C2BN Bullnose
		C1PR Prism	C2PR Prism

## Complete Table List Pricing

	Top Size	Base Qty.	Model #				
Round 	24	1	DI24RDOD	-	-	2,384	2,483
	30	1	DI30RDOD	1,942	-	2,904	3,025
	36	1	DI36RDOD	2,410	-	3,910	4,073
	42	1	DI42RDOD	2,598	-	4,658	4,852
	48	1	DI48RDOD	3,012	-	5,772	6,013
	54	1	DI54RDOD	-	-	6,699	6,978
	60	1	DI60RDOD	-	-	7,751	8,074
Square 	24 24	1	DI2424SQOD	-	-	2,223	2,316
	30 30	1	DI3030SQOD	1,939	-	2,702	2,815
	36 36	1	DI3636SQOD	2,379	-	3,685	3,839
	42 42	1	DI4242SQOD	2,593	-	4,390	4,573
	48 48	1	DI4848SQOD	-	-	5,481	5,709
Rectangle 	24 30	1	DI2430REOD	1,816	-	2,442	2,544
	24 36	1	DI2436REOD	-	-	3,003	3,128
	24 42	1	DI2442REOD	-	-	3,216	3,350
	24 48	1	DI2448REOD	-	-	3,431	3,574
	24 60	2	DI2460REOD	-	-	4,576	4,767
	24 72	2	DI2472REOD	-	-	5,032	5,242
	30 36	1	DI3036REOD	-	-	3,313	3,451
	30 42	1	DI3042REOD	-	-	3,576	3,725
	30 48	1	DI3048REOD	2,725	-	4,136	4,308
	30 60	2	DI3060REOD	-	-	5,090	5,302
	30 72	2	DI3072REOD	-	-	5,638	5,873
	36 42	1	DI3642REOD	-	-	4,302	4,481
	36 48	1	DI3648REOD	-	-	5,196	5,412
	36 60	2	DI3660REOD	-	-	6,335	6,599
	36 72	2	DI3672REOD	-	-	6,960	7,250
	36 84	2	DI3684REOD	-	-	-	-
	36 96	2	DI3696REOD	-	-	-	-

## How to Order

Table Model Number							Options
DI Base Series	36 Top Size	RD Top Shape	OD Outdoor	MES Top Material	MBM Top Finish	MSL Base Finish	AH Alternate Height Base
A DI36RDODMESMBMMSL is an outdoor Disc series 36" round table with a silver powder coat round base and a metal .75" thick top with a metal eased edge profile.					The code: MBM specifies a black matte powder coat top.		The code: AH specifies alternate height base

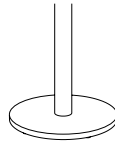

---

### Options

#### Base Finishes

Custom Powder Coat (set-up charge)	CPC	
Stainless Steel (per base)	use finish code	1,733

#### Base Options

Counter, Bar, & Alternate Height (per column)	CH, BH, AH	80
Custom Top Plate Size	CTPS	
6" Column (powder coat)	COL6	

#### Top Options

3" Radius Corner (per corner)	CRL3	42
(Corian®) Custom Size	CS	
Custom Radius Corner	CRC	100
Custom Shape	CSH	
Standard Powder Coat	use finish code	n/c
2" Umbrella Hole	UMB	300

Call for pricing

415.621.6656

# FLAT ROUND – Outdoor

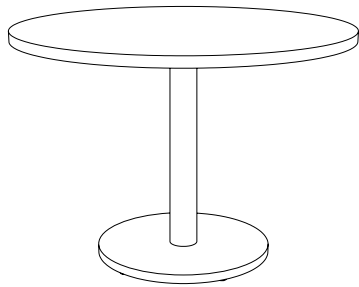

## Metal Surface      Solid Surface

Metal Surface		Solid Surface	
Metal Solid	Metal Mesh	Corian®	Corian®
MES Solid	MEM Mesh	C1FL Flat	C2FL Flat
		C1BN Bullnose	C2BN Bullnose
		C1PR Prism	C2PR Prism

## Complete Table List Pricing

	Top Size	Base Qty.	Model #				
Round 	24	1	FR24RDOD	-	-	2,245	2,339
	30	1	FR30RDOD	1,871	-	2,765	2,881
	36	1	FR36RDOD	2,272	-	3,685	3,839
	42	1	FR42RDOD	2,465	-	4,434	4,619
	48	1	FR48RDOD	2,645	-	5,281	5,501
	54	1	FR54RDOD	-	-	6,422	6,689
	60	1	FR60RDOD	-	-	7,473	7,784
Square 	24 24	1	FR2424SQOD	-	-	2,084	2,171
	30 30	1	FR3030SQOD	1,867	-	2,563	2,670
	36 36	1	FR3636SQOD	2,239	-	3,461	3,605
	42 42	1	FR4242SQOD	2,460	-	4,165	4,338
	48 48	1	FR4848SQOD	-	-	5,202	5,419
Rectangle 	24 30	1	FR2430REOD	1,740	-	2,305	2,401
	24 36	1	FR2436REOD	-	-	2,521	2,626
	24 42	1	FR2442REOD	-	-	2,990	3,114
	24 48	1	FR2448REOD	-	-	3,206	3,340
	24 60	2	FR2460REOD	-	-	4,301	4,480
	24 72	2	FR2472REOD	-	-	4,756	4,954
	30 36	1	FR3036REOD	-	-	2,831	2,949
	30 42	1	FR3042REOD	-	-	3,351	3,491
	30 48	1	FR3048REOD	2,350	-	3,643	3,795
	30 60	2	FR3060REOD	-	-	4,814	5,015
	30 72	2	FR3072REOD	-	-	5,362	5,585
	36 42	1	FR3642REOD	-	-	4,077	4,247
	36 48	1	FR3648REOD	-	-	4,703	4,899
	36 60	2	FR3660REOD	-	-	5,371	5,595
	36 72	2	FR3672REOD	-	-	5,997	6,247
36 84	2	FR3684REOD	-	-	-	-	
36 96	2	FR3696REOD	-	-	-	-	

## How to Order

Table Model Number						Options	
FR Base Series	36 Top Size	RD Top Shape	OD Outdoor	AAOP Top Material	AGL Top Finish	MSA Base Finish	AH Alternate Height Base

A FR36RDODAAOPAGLMSA is an outdoor Flat Round series 36" round table with a satin aluminum round base and an opaque acrylic top.

The code: AAOP specifies an acrylic top in Glacier

The code: AH specifies alternate height base

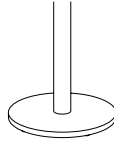

**Options**

**Base Finishes**

Custom Powder Coat (set-up charge)	CPC	📞
Stainless Steel (per base)	use finish code	1,733

**Base Options**

Counter, Bar, & Alternate Height (per column)	CH, BH, & AH	80
Super Level Glides (per base)	GSL	n/c
Custom Top Plate Size	CTPS	📞
6" Column (black texture & powder coat)	COL6	235

**Top Options**

3" Radius Corner (per corner) (Corian®)	CRL3	42
Custom Radius Corner (per corner)	CRC	100
Custom Size	CS	📞
Custom Shape	CSH	📞
2" Umbrella Hole	UMB	300

📞 Call for pricing

415.621.6656

# PLATFORM – Outdoor

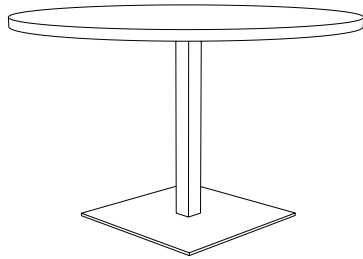

## Metal Surface      Solid Surface

Metal Surface		Solid Surface	
Metal Solid	Metal Mesh	Corian*	Corian*
MES Solid	MEM Mesh	C1FL Flat	C2FL Flat
		C1BN Bullnose	C2BN Bullnose
		C1PR Prism	C2PR Prism

## Complete Table List Pricing

	Top Size	Base Qty.	Model #				
Round 	30	1	PL30RDOD	1,960	-	2,904	3,025
	36	1	PL36RDOD	2,433	-	3,910	4,073
	48	1	PL48RDOD	3,040	-	5,772	6,013
	54	1	PL54RDOD	-	-	6,699	6,978
	60	1	PL60RDOD	-	-	7,751	8,074
Square 	24 24	1	PL2424SQOD	-	-	2,222	2,314
	30 30	1	PL3030SQOD	1,957	-	2,702	2,815
	36 36	1	PL3636SQOD	2,401	-	3,685	3,839
	42 42	1	PL4242SQOD	2,617	-	4,389	4,572
	48 48	1	PL4848SQOD	-	-	5,479	5,708
Rectangle 	24 30	1	PL2430REOD	1,833	-	2,443	2,545
	24 36	1	PL2436REOD	-	-	3,002	3,127
	24 42	1	PL2442REOD	-	-	3,214	3,348
	24 48	1	PL2448REOD	-	-	3,431	3,574
	24 60	2	PL2460REOD	-	-	4,576	4,767
	24 72	2	PL2472REOD	-	-	5,032	5,242
	24 84	2	PL2484REOD	-	-	-	-
	24 96	2	PL2496REOD	-	-	-	-
	30 36	1	PL3036REOD	-	-	3,313	3,451
	30 42	1	PL3042REOD	-	-	3,577	3,726
	30 48	1	PL3048REOD	2,749	-	4,134	4,307
	30 60	2	PL3060REOD	-	-	5,090	5,302

## How to Order

Table Model Number							Options
PL Base Series	36 Top Size	RD Top Shape	OD Outdoor	MES Top Material	MBM Top Finish	MSL Base Finish	AH Alternate Height Base
A PL36RDODMESMBMMSL is an outdoor Platform series 36" round table with a silver powder coat square base and a solid metal .75" thick top with a metal eased edge profile.					The code: MBM specifies a black matte powder coat top.		The code: AH specifies alternate height base

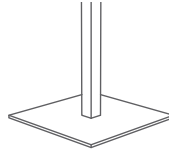

Single Column Base

**Options**

**Base Finishes**

Custom Powder Coat (set-up charge)	CPC	📞
Stainless Steel (per base)	use finish code	1,733

**Base Options**

Counter, Bar, & Alternate Height (per column)	CH, BH, AH	80
Custom Top Plate Size	CTPS	📞
6" Column (powder coat)	COL6	📞

**Top Options**

3" Radius Corner (per corner)	CRL3	42
(Corian™) Custom Size	CS	📞
Custom Radius Corner	CRC	100
Custom Size	CS	📞
Custom Shape	CSH	📞
Standard Powder Coat	use finish code	n/c
2" Umbrella Hole	UMB	300







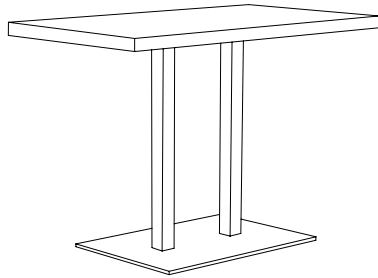

📞 Call for pricing

415.621.6656

# PLATFORM DOUBLE – Outdoor



## Metal Surface      Solid Surface

Metal Surface		Solid Surface	
Metal Solid	Metal Mesh	Corian®	Corian®
			
MES Solid	MEM Mesh	C1FL Flat	C2FL Flat
			
		C1BN Bullnose	C2BN Bullnose
			
		C1PR Prism	C2PR Prism

## Complete Table List Pricing

	Top Size	Base Qty.	Model #					
Rectangle	30 42	1	PLD3042REOD	-	-	3,988	4,154	
	30 48	1	PLD3048REOD	2,880	-	4,279	4,458	
								

## How to Order

### Table Model Number

<b>PLD</b> Base Series	<b>3048</b> Top Size	<b>RE</b> Top Shape	<b>OD</b> Outdoor	<b>MES</b> Top Material	<b>MBM</b> Top Finish	<b>MSL</b> Base Finish
---------------------------	-------------------------	------------------------	----------------------	----------------------------	--------------------------	---------------------------

### Options

**AH**  
Alternate  
Height Base

A PLD3048REODMESMBMMSL is a Platform Double series 30" x 48" rectangle table with a silver powder coat square base and a solid metal .75" thick top with a metal eased edge profile.

The code: MBM specifies a black matte powder coat top.

The code: AH specifies alternate height base

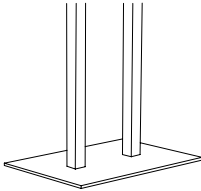

Double Column Base









**Options**

<b>Base Finishes</b>		
Custom Powder Coat (set-up charge)	CPC	📞
Stainless Steel (per base)	use finish code	1,733
<hr/>		
<b>Base Options</b>		
Counter, Bar, & Alternate Height (per column)	CH, BH, AH	80
Custom Top Plate Size	CTPS	📞
6" Column (powder coat)	COL6	📞
<hr/>		
<b>Top Options</b>		
3" Radius Corner (per corner)	CRL3	42
(Corian®) Custom Size	CS	📞
Custom Radius Corner	CRC	100
Custom Size	CS	📞
Custom Shape	CSH	📞
2" Umbrella Hole	UMB	300



📞 Call for pricing

415.621.6656

# TULIP – Outdoor

	Metal Surface		Solid Surface	
	Metal Solid	Metal Mesh	Corian®	Corian®
				
	MES Solid	MEM Mesh	C1FL Flat	C2FL Flat
				
		C1BN Bullnose	C2BN Bullnose	
				
		C1PR Prism	C2PR Prism	

## Complete Table List Pricing

	Top Size		Base Qty.	Model #				
<b>Round</b>  	24		1	TL24RDOD	-	-	2,599	2,707
	30		1	TL30RDOD	2,291	-	3,225	3,359
	36		1	TL36RDOD	2,581	-	4,023	4,191
	42		1	TL42RDOD	2,841	-	4,846	5,048
	48		1	TL48RDOD	3,226	-	5,914	6,160
	54		1	TL54RDOD	-	-	6,905	7,193
<b>Square</b>  	24	24	1	TL2424SQOD	-	-	2,438	2,540
	30	30	1	TL3030SQOD	2,287	-	3,021	3,147
	36	36	1	TL3636SQOD	2,548	-	3,798	3,956
	42	42	1	TL4242SQOD	3,041	-	4,798	4,998
	48	48	1	TL4848SQOD	-	-	5,687	5,924
<b>Rectangle</b>  	24	30	1	TL2430REOD	2,161	-	2,764	2,879
	24	36	1	TL2436REOD	-	-	3,114	3,244
	24	42	1	TL2442REOD	-	-	3,402	3,543
	24	48	1	TL2448REOD	-	-	3,839	3,999
	24	60	2	TL2460REOD	-	-	5,008	5,217
	24	72	2	TL2472REOD	-	-	5,463	5,691
	24	84	2	TL2484REOD	-	-	-	-
	24	96	2	TL2496REOD	-	-	-	-
	30	36	1	TL3036REOD	-	-	3,425	3,568
	30	42	1	TL3042REOD	-	-	3,763	3,920
	30	48	1	TL3048REOD	2,929	-	4,275	4,454
	30	60	2	TL3060REOD	-	-	5,731	5,970

## How to Order

Table Model Number							Options
<b>TL18H</b> Base Series	<b>36</b> Top Size	<b>RD</b> Top Shape	<b>OD</b> Outdoor	<b>MES</b> Top Material	<b>MBM</b> Top Finish	<b>MSL</b> Base Finish	<b>AH</b> Alternate Height Base
<p>A TL18H36RDODMESMBMMSL is an outdoor Tulip series 36" round table with a silver powder coat round base and a solid metal .75" thick top with a metal eased edge profile.</p>					<p>The code: MBM specifies a black matte powder coat top</p>		<p>The code: AH specifies alternate height base</p>

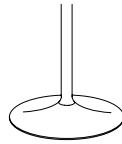

---

### Options

#### Base Finishes

Custom Powder Coat (set-up charge)	CPC	📞
Stainless Steel (per base)	use finish code	1,733

#### Base Options

Counter, Bar, & Alternate Height (per column)	CH, BH, AH	80
Custom Top Plate Size	CTPS	📞

#### Top Options

3" Radius Corner (per corner) (Corian®)	CRL3	42
Custom Radius Corner (per corner)	CRC	100
Custom Size	CS	📞
Custom Shape	CSH	📞

📞 Call for pricing

415.621.6656

# VISTA – Outdoor

## Solid Surface

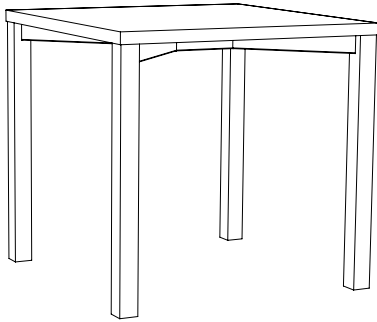

Corian®  
Group A





C1FL  
Flat

Corian®  
Group B



C2FL  
Flat

## Complete Table List Pricing

	Top Size		Base Qty.	Model #	
Square 	36	36	1	VS3636SQOD	4,513
	42	42	1	VS4242SQOD	5,031
	48	48	1	VS4848SQOD	6,265
Rectangle 	24	60	1	VS2460REOD	4,101
	24	72	1	VS2472REOD	4,756
	24	84	1	VS2484REOD	5,391
	24	96	1	VS2496REOD	6,007
	24	120	1	VS24120REOD	7,208
	30	60	1	VS3060REOD	5,125
	30	72	1	VS3072REOD	5,594
	30	84	1	VS3084REOD	6,113
	30	96	1	VS3096REOD	6,811
	30	120	1	VS30120REOD	8,174
	36	60	1	VS3660REOD	5,702
	36	72	1	VS3672REOD	6,197
	36	84	1	VS3684REOD	6,466
	36	96	1	VS3696REOD	7,205
	36	120	1	VS36120REOD	8,646
	42	60	1	VS4260REOD	6,727
	42	72	1	VS4272REOD	7,182
	42	84	1	VS4284REOD	8,139
42	96	1	VS4296REOD	9,071	
42	120	1	VS42120REOD	10,885	

## How to Order

### Table Model Number

<b>VS</b> Base Series	<b>3636</b> Top Size	<b>SQ</b> Top Shape	<b>OD</b> Outdoor	<b>COFL</b> Top Material Edge Profile	<b>CDW</b> Top Finish	<b>MBM</b> Base Finish
--------------------------	-------------------------	------------------------	----------------------	---	--------------------------	---------------------------

A VS3636SQODCOFLCDWMBM is a Vista series 36" x 36" square table with a black powder coat base and a Corian® top with a flat edge profile.

The code: CDW specifies a Corian® top in designer white.

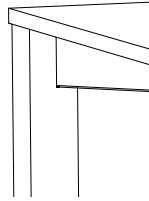

---

## Options

---

### Base Finishes

Custom Powder Coat (set-up charge)	CPC	
Stainless Steel (per base)	use finish code	2,426

### Base Options

Counter Height	CH	pages 170-171
Bar Height	BH	pages 170-171
Alternative Height	AH	

### Top Options

2" Umbrella Hole (base provided by other)	UMB	87
---	-----	----

 Call for pricing



415.621.6656

# VISTA – Outdoor - Counter and Bar Height

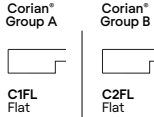
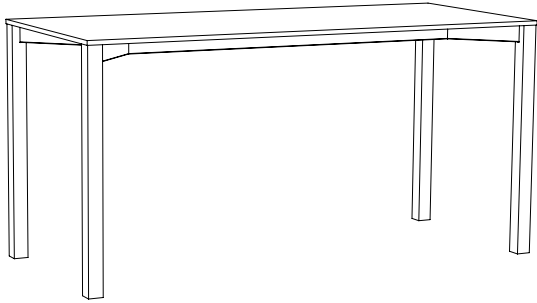
## Solid Surface



## Complete Table List Pricing

	Top Size	Base Qty.	Model #		
Square 	36 36	1	VS3636SQOD	6,043	6,295
	42 42	1	VS4242SQOD	6,667	6,945
	48 48	1	VS4848SQOD	8,152	8,492
Rectangle 	24 60	1	VS2460REOD	5,547	5,778
	24 72	1	VS2472REOD	6,336	6,600
	24 84	1	VS2484REOD	7,100	7,396
	24 96	1	VS2496REOD	7,842	8,169
	24 120	1	VS24120REOD	9,289	9,676
	30 60	1	VS3060REOD	6,781	7,063
	30 72	1	VS3072REOD	7,343	7,649
	30 84	1	VS3084REOD	7,969	8,301
	30 96	1	VS3096REOD	8,811	9,178
	30 120	1	VS30120REOD	10,452	10,887
	36 60	1	VS3660REOD	7,475	7,787
	36 72	1	VS3672REOD	8,072	8,408
	36 84	1	VS3684REOD	8,395	8,745
	36 96	1	VS3696REOD	9,285	9,672
	36 120	1	VS36120REOD	11,019	11,479
	42 60	1	VS4260REOD	8,708	9,071
	42 72	1	VS4272REOD	9,257	9,643
	42 84	1	VS4284REOD	10,410	10,843
	42 96	1	VS4296REOD	11,530	12,011
42 120	1	VS42120REOD	13,715	14,286	

## How to Order

### Table Model Number

**VS** Base Series   
 **3636** Top Size   
 **SQ** Top Shape   
 **OD** Outdoor   
 **COFL** Top Material Edge Profile   
 **CDW** Top Finish   
 **MBM** Base Finish

A VS3636SQODCOFLCDWMBM-BH is a Vista series 36" x 36" square table with a black powder coat base and a Corian® top with a flat edge profile.

The code: CDW specifies a Corian® top in Designer white.

### Options

**BH** Base Height

The code: BH specifies bar height base.

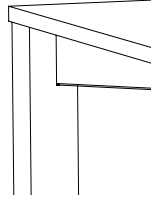

---

### Options

---

#### Base Finishes

Custom Powder Coat (set-up charge)	CPC	
Stainless Steel (per base)	use finish code	2,426

---

#### Base Options

Alternative Height	AH	
--------------------	----	---

---

#### Top Options

2" Umbrella Hole (base provided by other)	UMB	87
---	-----	----

---

 Call for pricing

415.621.6656







# Base and Top Matrix

174

Base and Top Matrix

# BASE AND TOP MATRIX





		Basic Round						Blok			Bolt Down	Brae			Brae Double	Disc			
		BA17L	BA17M	BA20M	BA22L	BA22M	BA22H	BA28H	BL18	BL22	BL26	JB	BR18	BR22	BR26	BRD1826	D18	D22	D26
 Round	Dia																		
	24	1							1			1						1	
	30		1						1			1	1					1	
	36			1						1		1	1						1
	42				1							1							1
	48					1					1	1		1					1
	54						1								1				1
	60							1							1				1
 Oval	W L																		
	36 72																		2
	42 54																		2
	42 78																		2
	42 84																		2
	48 78																		2
	48 96																		2
 RD Square	W L																		
	24 24	1										1	1					1	
	30 30		1									1	1					1	
	36 36			1								1		1					1
	42 42				1							1		1					1
	48 48						1					1			1				1
 Square	W L																		
	24 24	1							1			1	1					1	
	30 30		1						1			1	1					1	
	36 36			1						1		1		1					1
	42 42				1						1	1		1					1
	48 48						1					1			1				1

Based on standard height tables with standard tops. For quartz and other heavy tops, call WCI's Customer Service Department.

**BASE AND TOP MATRIX**

Rectangle	W	L	Basic Round						Blok			Bolt Down	Brae			Brae Double	Disc		
			BA17L	BA17M	BA20M	BA22L	BA22M	BA22H	BA28H	BL18	BL22	BL26	JB	BR18	BR22	BR26	BRD1826	D18	D122
	18	48																	
	18	60																	
	18	72																	
	18	84																	
	18	96																	
	24	30		1					1			1		1				1	
	24	36			1					1		1		1					1
	24	42				1				1		1		1		1			1
	24	48					1			2		1		1		1			1
	24	60	2							2		2		2				2	
	24	72	2									2		2				2	
	24	84												2				2	
	24	96												2				2	
	30	36			1					1		1		1				1	
	30	42				1				1		1		1		1			1
	30	48					1				1	1		1		1			1
	30	60		2						2		2		2				2	
	30	72		2						2		2		2				2	
	30	84												2				2	
	30	96												2				2	
	36	42					1			1		1		1		1			1
	36	48						1			1	1		1		1			1
	36	60			2					2		2		2				2	
	36	72			2					2		2		2				2	
	36	84												2				2	
	36	96												2				2	
	42	72													2				2
	42	84													2				2
	42	96													2				2
	48	96													2				2
	48	120													2				2

# BASE AND TOP MATRIX





		Dunhill					Flat Round			Kone			Platform			Platform Double					
		DU1818X	DU2424X	DU3030X	DU3636X	DU3636XH	DU18T	DU24T	DU30T	DU30TT	DU36TT	FR18	FR22	FR26	KO18	KO22	KO26	PL18	PL22	PL26	PLD1826
<b>Round</b> 	<b>Dia</b>																				
	24	1									1			1							
	30		1								1			1			1				
	36			1								1			1			1			
	42			1								1									
	48				1							1				1			1		
	54					1							1						1		
	60					1							1						1		
<b>Oval</b> 	<b>W L</b>																				
	36 72							2			2										
	42 54							2			2										
	42 78							2				2									
	42 84							2				2									
	48 78								2				2								
48 96								2				2									
<b>RD Square</b> 	<b>W L</b>																				
	24 24	1									1										
	30 30		1								1										
	36 36			1								1									
	42 42				1							1									
48 48				1								1									
<b>Square</b> 	<b>W L</b>																				
	24 24	1									1			1			1				
	30 30		1								1			1			1				
	36 36			1								1			1			1			
	42 42				1							1				1		1			
48 48				1								1			1			1			

Based on standard height tables with standard tops. For quartz and other heavy tops, call WCI's Customer Service Department.

# BASE AND TOP MATRIX

Rectangle	W	L	Dunhill					Flat Round			Kone			Platform			Platform Double					
			DU1818X	DU2424X	DU3030X	DU3636X	DU3636XH	DU18T	DU24T	DU30T	DU30TT	DU36TT	FR18	FR22	FR26	KO18	KO22	KO26	PL18	PL22	PL26	PLD1826
	18	48																				
	18	60																				
	18	72																				
	18	84																				
	18	96																				
	24	30		1								1			1			1				
	24	36			1							1			1			1				
	24	42			1							1			1			1			1	
	24	48			1							1			2			1			1	
	24	60										2			2			2				
	24	72										2						2				
	24	84										2						2				
	24	96										2						2				
	30	36			1							1				1		1				
	30	42										2			1			1			1	
	30	48				1						2			1			1			1	
	30	60										2			2			2				
	30	72										2			2			2				
	30	84										2						2				
	30	96										2						2				
	36	42										2			2			1			1	
	36	48										2			1			1			1	
	36	60										2			2			2				
	36	72										2			2			2				
	36	84										2						2				
	36	96										2						2				
	42	72										2			2						2	
	42	84										2			2						2	
	42	96										2			2						2	
	48	96										2			2						2	
	48	120										2			2						2	

# BASE AND TOP MATRIX





		Plus					Post Leg		Regency					Tulip										
		PU1818X	PU2424X	PU3030X	PU3636X	PU3636XH	PU18T	PU24T	PU30T	PU30TT	PU36TT	PO2.5"	PO3"	RG2424X	RG3030X	RG3636X	RG2142S	RG2448S	TL18L	TL18M	TL18H	TL24m	TL24H	TL24XH
<b>Round</b> 	<b>Dia</b>																							
	24	1																	1					
	30		1											1						1				
	36			1							4			1							1			
	42			1								4		1								1		
	48				1								4			1							1	
	54					1							4			1								1
	60					1							4			1								
<b>Oval</b> 	<b>W L</b>																							
	36 72								2		4					1					2			
	42 54								2			4				1					2			
	42 78								2			4				1						2		
	42 84								2			4						1				2		
	48 78									2			4					1					2	
	48 96									2			4					1					2	
<b>RD Square</b> 	<b>W L</b>																							
	24 24	1																						
	30 30		1											1										
	36 36			1											1									
	42 42				1											1								
	48 48				1											1								
<b>Square</b> 	<b>W L</b>																							
	24 24	1																	1					
	30 30		1											1						1				
	36 36			1								4			1						1			
	42 42				1								4			1							1	
	48 48				1								4			1								1

Based on standard height tables with standard tops. For quartz and other heavy tops, call WCI's Customer Service Department.

**BASE AND TOP MATRIX**

Rectangle	W	L	Plus					Post Leg		Regency					Tulip										
			PU1818X	PU2424X	PU3030X	PU3636X	PU3636XH	PU18T	PU24T	PU30T	PU30TT	PU36TT	PO2.5"	PO3"	RG2424X	RG3030X	RG3636X	RG2142S	RG2448S	TL18L	TL18M	TL18H	TL24m	TL24H	TL24XH
	18	48						2																	
	18	60						2																	
	18	72						2																	
	18	84						2																	
	18	96						2																	
	24	30		1															1						
	24	36			1															1					
	24	42			1			2														1			
	24	48			1			2															1		
	24	60						2											2						
	24	72						2											2						
	24	84						2											2						
	24	96						2											2						
	30	36			1																1				
	30	42						2														1			
	30	48			1			2					1											1	
	30	60						2			4								2						
	30	72						2			4								2						
	30	84						2			4								2						
	30	96						2			4								2						
	36	42							2		4											1			
	36	48							2		4												1		
	36	60							2		4									2					
	36	72							2		4									2					
	36	84							2		4									2					
	36	96								2	4									2					
	42	72										4										2			
	42	84										4										2			
	42	96										4										2			
	48	96									2		4											2	
	48	120									2		6											2	

# BASE AND TOP MATRIX

		Tulip					
		TL18L	TL18M	TL18H	TL24m	TL24H	TL24XH
<b>Round</b> 	<b>Dia</b>						
	24	1					
	30		1				
	36			1			
	42				1		
	48					1	
	54						1
	60						
<b>Oval</b> 	<b>W L</b>						
	36 72			2			
	42 54			2			
	42 78				2		
	42 84				2		
	48 78					2	
	48 96					2	
<b>RD Square</b> 	<b>W L</b>						
	24 24						
	30 30						
	36 36						
	42 42						
	48 48						
<b>Square</b> 	<b>W L</b>						
	24 24	1					
	30 30		1				
	36 36			1			
	42 42					1	
48 48						1	

Based on standard height tables with standard tops. For quartz and other heavy tops, call WCI's Customer Service Department.

		Tulip					
		TL18L	TL18M	TL18H	TL24m	TL24H	TL24XH
Rectangle	W	L					
	18	48					
	18	60					
	18	72					
	18	84					
	18	96					
	24	30		1			
	24	36			1		
	24	42				1	
	24	48					1
	24	60	2				
	24	72	2				
	24	84	2				
	24	96	2				
	30	36			1		
	30	42				1	
	30	48					1
	30	60		2			
	30	72		2			
	30	84		2			
	30	96		2			
	36	42				1	
	36	48					1
	36	60			2		
	36	72			2		
	36	84			2		
	36	96			2		
	42	72				2	
	42	84				2	
	42	96				2	
	48	96					2
48	120					2	



# Base Only Pricing

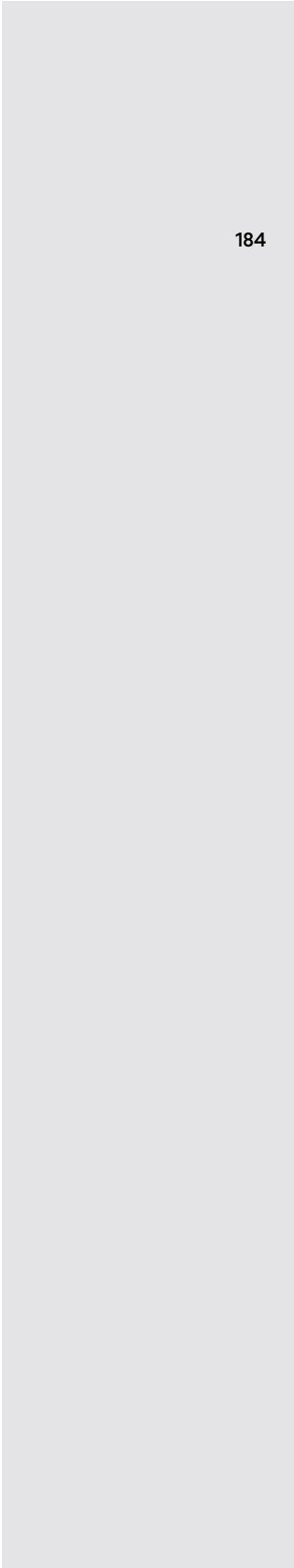

184

Base Only Pricing

# BASE ONLY – Dining & Multipurpose

## BASE ONLY LIST PRICING

Base	Code	Base Model #	Price	Base Size*	Base Style	Col. Dia.	Base Weight Lbs.	
Basic Round	BA	BA17L	284	17" dia.	Round	3"	29	
		BA17M	345	17" dia.	Round	3"	41	
		BA17H	402	17" dia.	Round	3"	45	
		BA20L	373	20" dia.	Round	3"	44	
		BA20M	402	20" dia.	Round	3"	51	
		BA20H	442	20" dia.	Round	3"	57	
		BA22L	392	22" dia.	Round	3"	50	
		BA22M	462	22" dia.	Round	3"	58	
		BA22H	530	22" dia.	Round	3"	65	
		BA28H	783	28" dia.	Round	3.5"	80	
Bolt Down	J Base	JB	JB	431	3" dia.	Boltdown	3"	10
Brae	BR	BR18	853	18"	RD Square	2"	46	
		BR22	1,167	22"	RD Square	2"	65	
		BR26	1,412	26"	RD Square	3"	97	
Brae Double	BRD	BRD1826	1,545	18" x 26"	RD Rectangle	2"	75	
Disc	DI	DI18	853	18" dia	Round	2"	38	
		DI22	1,167	22" dia	Round	2"	62	
		DI26	1,412	26" dia	Round	3"	77	
Dunhill	DU	DU1818X	923	18" x 18"	X	2.25"	18	
		DU2424X	1,055	24" x 24"	X	2.25"	25	
		DU3030X	1,184	30" x 30"	X	3	34	
		DU3636X	1,315	36" x 36"	X	3"	42	
		DU3636XH	1,440	36" x 36"	XH	3"	50	
		DU18T	543	18"	T	2"	30	
		DU24T	603	24"	T	2.25"	34	
		DU30T	667	30"	T	2.25"	40	
		DU30TT	778	30"	TT	2.25"	44	
		DU36TT	839	36"	TT	2.25"	62	
Flat Round	FR	FR18	726	18" dia.	Round	3"	46	
		FR22	962	22" dia.	Round	3.5"	70	
		FR26	1,158	26" dia.	Round	3.5"	84	
Platform	PL	PL18	853	18" square	Sq.	2" Square	46	
		PL22	1,167	22" square	Sq.	2" Square	65	
		PL26	1,412	26" square	Sq.	3" Square	97	
		PL1826	1,545	18" x 26"	Rectangle	2" Square	75	

Continued on next page

Continued on next page

\*Base sizes may vary depending on weight of top

\*\*Polished/Satin Aluminum only available on Alumiline and Mark IV series  
Polished/Satin Chrome upcharge priced per column

\*\*\*Custom Powder Coat upcharge applied per order

**BASE ONLY FINISH UPCHARGES**

Black Wrinkle	Powder Coat	Satin/Polished Chrome/Alu.**	Premium Plated	Custom PowderCoat***	Stainless Steel
standard	127	348	696	530	N/A
standard	127	348	696	530	N/A
standard	127	348	696	530	N/A
standard	127	348	696	530	N/A
standard	127	348	696	530	N/A
standard	127	348	696	530	N/A
standard	127	348	696	530	N/A
standard	127	348	696	530	N/A
standard	127	348	696	530	N/A
- standard		111	174	530	2,087
- standard		557	904	530	2,087
- standard		557	904	530	2,087
- standard		557	904	530	2,087
- standard		557	939	530	2,087
- standard		557	904	530	2,087
- standard		557	904	530	2,087
- standard		557	904	530	2,087
- standard		522	904	530	2,087
- standard		522	904	530	2,087
- standard		522	904	530	2,087
- standard		522	904	530	2,087
- standard		262	487	530	2,087
- standard		262	487	530	2,087
- standard		262	487	530	2,087
- standard		262	487	530	2,087
- standard		348	696	530	2,087
- standard		348	696	530	2,087
- standard		348	696	530	2,087
- standard		557	939	530	2,087
- standard		557	939	530	2,087
- standard		557	939	530	2,087
- standard		557	939	530	2,087

**Base Options**

<b>Alternate Height</b>		
Counter, Bar, & Alternative Height	CH, BH, & AH	76
<b>Glides</b>		
Super Level	GSL	40
<b>Casters</b>		
Locking Casters 2" Twin Wheel (qty. 4) (Dunhill & Post Leg)	TWC2	65
Locking Casters 3" Mag Wheel (qty. 4) (Vista)	MWC3	193
<b>Top Plate</b>		
Custom Top Plate Size	CTPS	📞
<b>6" Column (Basic Round, Disc, or Flat Round)</b>		
6" Column (black texture and powder coat)	COL6	224
6" Column (polished or satin chrome)	COLP6	286
6" Column (premium plated)	COLPP6	📞
6" Column (veneer)	COLV6	446
<b>Footring (Basic Round, Flat Round, Bolt-down, Disc, or Platform)</b>		
Footring 14" (per base)	FO14	254
Footring 19" (per base)	FO19	286
Footring Finish: Polished or Satin Chrome only		
<b>Outdoor Use</b>		
Outdoor Undercoat (includes GSL)	OD	82
<b>Tilt-Top</b>		
Tilt-top - (standard cable release) TMX/TMT	284 X-base / 439 T-base	
For use on table bases with up to a 2.5" column diameter.		
The cable release mechanism activates both mechanisms on a table with two single column T-bases. It is not available on TT bases.		

📞 Call for pricing  
415.621.6656

## BASE ONLY – Dining & Multipurpose

### BASE ONLY LIST PRICING

Base	Code	Base Model #	Price	Base Size*	Base Style	Col. Dia.	Base Weight Lbs.
Platform Double	PLD	PL1826	1,545	18" x 26"	Rectangle	2" Square	75
Plus	PU	PU1818X	923	18" x 18"	X	2.25"	18
		PU2424X	1,055	24" x 24"	X	2.25"	25
		PU3030X	1,184	30" x 30"	X	3"	34
		PU3636X	1,315	36" x 36"	X	3"	42
		PU3636XH	1,440	36" x 36"	XH	3"	50
		PU18T	543	18"	T	2"	30
		PU24T	603	24"	T	2.25"	34
		PU30T	667	30"	T	2.25"	40
		PU30TT	778	30"	TT	2.25"	44
		PU36TT	839	36"	TT	2.25"	62
Post Leg	PO	PO1.5	284	1.5" dia.	Post	1.5"	4
		PO2.5	303	2.5" dia.	Post	2.5"	6
		PO3	323	3" dia.	Post	3"	7
Regency	RG	RG2424X	1,686	24" x 24"	X -bar size 1/2"	2.5"	18
		RG3030X	1,826	30" x 30"	X -bar size 1/2"	2.5"	22
		RG3636X	3,882	36" x 36"	X -bar size 1"	3.5"	60
		RG4848X	4,904	48" x 48"	X -bar size 1"	3.5"	86
		RG2142S	5,100	21" x 42"	Scissor -bar size 1"	3.5"	84
		RG2448S	5,295	24" x 48"	Scissor -bar size 1"	3.5"	85
Tulip	TL	TL18L	1,051	18" dia.	Round	2"	35
		TL18M	1,147	18" dia.	Round	2"	45
		TL18H	1,270	18" dia.	Round	2"	55
		TL24M	1,339	24" dia.	Round	2.25"	55
		TL24H	1,542	24" dia.	Round	2.25"	65
		TL24XH	1,602	24" dia.	Round	2.25"	75

\*Base sizes may vary depending on weight of top

\*\*Polished/Satin Aluminum only available on Alumiline and Mark IV series

\*\*\*Custom Powder Coat upcharge applied per order

**BASE ONLY FINISH UPCHARGES**

Black Wrinkle	Powder Coat	Satin/Polished Chrome/Alu.**	Premium Plated	Custom PowderCoat***	Stainless Steel
-	standard	557	939	530	2,087
-	standard	522	904	530	2,087
-	standard	522	904	530	2,087
-	standard	522	904	530	2,087
-	standard	522	904	530	2,087
-	standard	262	487	530	2,087
-	standard	262	487	530	2,087
-	standard	262	487	530	2,087
-	standard	262	487	530	2,087
-	standard	111	174	530	2,087
-	standard	111	174	530	2,087
-	standard	111	174	530	2,087
-	standard	1,044	2,087	530	N/A
-	standard	1,044	2,087	530	N/A
-	standard	1,044	2,087	530	N/A
-	standard	1,044	2,087	530	N/A
-	standard	1,044	2,087	530	N/A
-	standard	348	696	530	2,087
-	standard	348	696	530	2,087
-	standard	348	696	530	2,087
-	standard	348	696	530	2,087
-	standard	348	696	530	2,087
-	standard	348	696	530	2,087

**Base Options**

<b>Alternate Height</b>		
Counter, Bar, & Alternative Height	CH, BH, & AH	76
<b>Glides</b>		
Super Level	GSL	40
<b>Casters</b>		
Locking Casters 2" Twin Wheel (qty. 4) (Dunhill & Post Leg)	TWC2	65
Locking Casters 3" Mag Wheel (qty. 4) (Vista)	MWC3	193
<b>Top Plate</b>		
Custom Top Plate Size	CTPS	1
<b>6" Column (Basic Round, Disc, or Flat Round)</b>		
6" Column (black texture and powder coat)	COL6	224
6" Column (polished or satin chrome)	COLP6	286
6" Column (premium plated)	COLPP6	1
6" Column (veneer)	COLV6	446
<b>Footring (Basic Round, Flat Round, Bolt-down, Disc, or Platform)</b>		
Footring 14" (per base)	FO14	254
Footring 19" (per base)	FO19	286
Footring Finish: Polished or Satin Chrome only		
<b>Outdoor Use</b>		
Outdoor Undercoat (includes GSL)	OD	82
<b>Tilt-Top</b>		
Tilt-top - (standard cable release) TMX/TMT 284 X-base / 439 T-base		
For use on table bases with up to a 2.5" column diameter.		
The cable release mechanism activates both mechanisms on a table with		
two single column T-bases. It is not available on TT bases.		

1 Call for pricing  
415.621.6656

## BASE ONLY – Outdoor

### BASE ONLY LIST PRICING

Base	Code	Base Model #	Price	Base Size*	Base Style	Col. Dia.	Base Weight	
								Lbs.
Basic Round	BA	BA14LOD	346	14" dia.	Round	3"		30
		BA17LOD	366	17" dia.	Round	3"		35
		BA17MOD	427	17" dia.	Round	3"		45
		BA17HOD	484	17" dia.	Round	3"		55
		BA20LOD	455	20" dia.	Round	3"		45
		BA20MOD	484	20" dia.	Round	3"		55
		BA20HOD	523	20" dia.	Round	3"		65
		BA22LOD	475	22" dia.	Round	3"		55
		BA22MOD	544	22" dia.	Round	3"		65
		BA22HOD	612	22" dia.	Round	3"		75
		BA28HOD	866	28" dia.	Round	3"		95
Brae	BR	BR18OD	935	18"	RD Square	2"		46
		BR22OD	1,250	22"	RD Square	2"		65
		BR26OD	1,494	26"	RD Square	3"		97
Brae Double	BRD	BRD1826OD	1,545	18" x 26"	RD Rectangle	2"		75
Disc	DI	DI18OD	935	18" dia	Round	2"		38
		DI22OD	1,250	22" dia	Round	2"		62
		DI26OD	1,494	26" dia	Round	3"		77
Flat Round	FR	FR18OD	808	18" dia.	Round	3"		46
		FR22OD	1,044	22" dia.	Round	3.5"		70
		FR26OD	1,240	26" dia.	Round	3.5"		84
Platform	PL	PL18OD	935	18" square	Square	2" Square		46
		PL22OD	1,250	22" square	Square	2" Square		65
		PL26OD	1,494	26" square	Square	3" Square		97
		PL1826OD	1,627	18" x 26"	Rectangle	2" Square		75
Platform Double	PLD	PLD1826OD	1,627	18" x 26"	Rectangle	2" Square		75
Tulip	TL	TL18LOD	1,133	18" dia.	Round	2"		35
		TL18MOD	1,229	18" dia.	Round	2"		45
		TL18HOD	1,353	18" dia.	Round	2"		55
		TL24MOD	1,421	24" dia.	Round	2.25"		55
		TL24HOD	1,624	24" dia.	Round	2.25"		65
		TL24XHOD	1,684	24" dia.	Round	2.25"		75

\*Polished/Satin Aluminum only available on Alumiline and Mark IV series

\*\*Custom Powder Coat upcharge applied per order







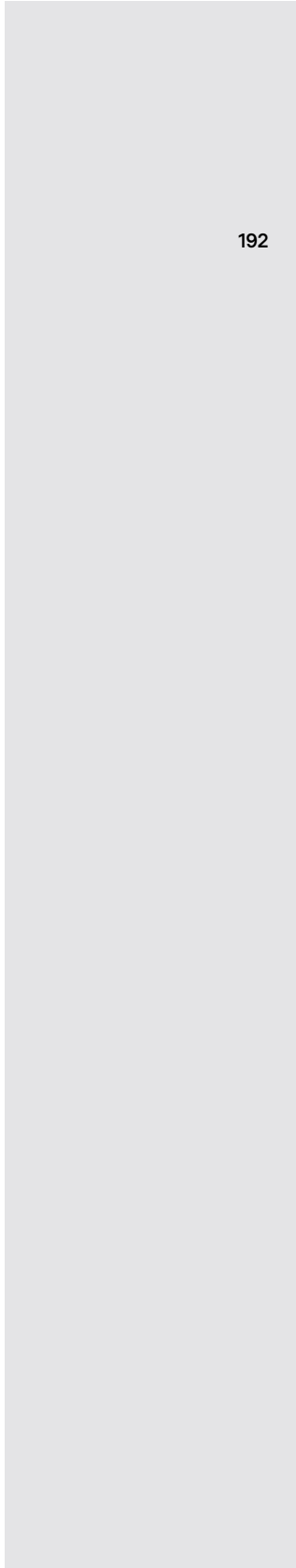















# Top Only Pricing







192

Top Only Pricing











# TOP ONLY

Laminate Surface					Wood Surface				
Self Edge	Vinyl Edges	PVC Edges	Wood Edges Group A	Wood Edges Group B	Wood Edges Group A	Wood Edges Group B	Butcher Block		
 LLSE Self Edge	 LVFL Flat	 LPVC PVC	 LWFL Flat	 LWSQ Square	 WWFL Flat	 WWSQ Square	 BBFL Flat		
	 LVBP Bumper		 LWTP Tapered Ply	 LWBN Bullnose	 WWTP Tapered Ply	 WWBN Bullnose	 BBBN Bullnose		
			 LWFP Flat Ply	 LWPR Prism	 WWFP Flat Ply	 WWPR Prism			

## Top Only List Pricing

	Top Size		Model #								
<b>Round</b> 	24		24RD	330	330	417	696	991	712	1,117	970
	30		30RD	437	437	544	893	1,209	893	1,362	1,401
	36		36RD	576	576	703	1,115	1,481	1,159	1,664	1,938
	42		42RD	753	753	895	1,316	1,769	1,481	1,988	2,858
	48		48RD	934	934	1,092	1,560	2,079	1,755	2,339	3,340
	54		54RD	1,129	1,129	1,312	1,938	3,010	2,180	3,384	-
	60		60RD	1,437	1,437	1,635	2,147	3,153	2,777	3,548	-
<b>Oval</b> 	36	72	3672OV	1,092	1,092	1,181	1,546	1,936	1,848	2,226	-
	42	54	4254OV	1,052	1,052	1,101	1,458	2,030	1,723	2,137	-
	42	78	4278OV	1,563	1,563	1,636	1,975	2,360	2,224	2,655	-
	42	84	4284OV	1,661	1,661	1,756	2,062	2,502	2,317	2,815	-
	48	78	4878OV	1,723	1,723	1,823	2,118	2,555	2,386	2,875	-
	48	96	4896OV	2,030	2,030	2,129	2,378	2,854	3,013	3,568	-
<b>RD Square</b> 	24	24	2424RS	333	333	429	696	991	712	1,117	1,092
	30	30	3030RS	437	437	555	893	1,209	893	1,362	1,563
	36	36	3636RS	576	576	696	1,095	1,481	1,159	1,664	2,144
	42	42	4242RS	731	731	866	1,316	1,769	1,481	1,988	3,181
	48	48	4848RS	936	936	1,092	1,560	2,079	1,755	2,339	3,718
<b>Square</b> 	17	17	1717SQ	-	-	-	-	-	-	-	-
	20	20	2020SQ	-	-	-	-	-	-	-	-
	24	24	2424SQ	333	333	429	696	991	712	1,117	1,092
	30	30	3030SQ	437	437	555	893	1,209	893	1,362	1,563
	36	36	3636SQ	576	576	696	1,095	1,481	1,159	1,664	2,144
	42	42	4242SQ	731	731	866	1,316	1,769	1,481	1,988	3,181
	48	48	4848SQ	936	936	1,092	1,560	2,079	1,755	2,339	3,718

Continued on next page

Solid Surface		Quartz Surface	
Corian® Group A	Corian® Group B	Quartz Q1	Quartz® Q2
 C1FL Flat	 C2FL Flat	 Q1FL Flat	 Q2FL Flat
 C1BN Bullnose	 C2BN Bullnose	 Q1BN Bullnose	 Q2BN Bullnose
 C1PR Prism	 C2PR Prism		

1,363	1,420	3,063	4,125
1,884	1,962	4,029	5,994
2,547	2,653	5,663	7,240
3,296	3,433	7,026	9,320
4,143	4,315	-	-
5,069	5,280	-	-
6,121	6,376	-	-
-	-	-	-
-	-	-	-
-	-	-	-
-	-	-	-
-	-	-	-
-	-	-	-
-	-	-	-
-	-	-	-
-	-	-	-
-	-	-	-
-	-	-	-
-	-	-	-
-	-	-	-
-	-	-	-
1,202	1,252	1,873	3,495
1,682	1,752	3,254	5,157
2,323	2,419	4,230	6,488
3,027	3,153	5,891	8,149
3,850	4,010		

Options



















Top Materials and Finishes			
Premium Laminates			📞
Custom Wood Veneer	CWV		📞
Stain to Match (set-up charge)	STM		476
Top Options			
3" Radius Corner (per corner) (Laminate self edge & Corian®)	CRL3		40
3" Wood Radius Corner (per corner) (not available in LWFL, WWFL, LWPI and WWPI)	CRW3		95
Custom Radius Corner	CRC		95
Custom Size	CS		📞
Custom Shape	CSH		📞
Edge Options			
1.75" Thick Edge (see edge details for specific profiles)	175E		5% (per table)

📞 Call for pricing 415.621.6656

# TOP ONLY

## Laminate Surface

## Wood Surface

Self Edge	Vinyl Edges	PVC Edges	Wood Edges Group A	Wood Edges Group B	Wood Edges Group A	Wood Edges Group B	Butcher Block
 LLSE Self Edge	 LVFL Flat	 LPVC PVC	 LWFL Flat	 LWSQ Square	 WWFL Flat	 WWSQ Square	 BBFL Flat
	 LVBP Bumper		 LWTP Tapered Ply	 LWBN Bullnose	 WWTP Tapered Ply	 WWBN Bullnose	 BBBN Bullnose
			 LWFP Flat Ply	 LWPR Prism	 WWFP Flat Ply	 WWPR Prism	



















## Top Only List Pricing

Rectangle	Top Size	Model #								
	18 48	1848RE	458	458	547	753	1,190	868	1,238	1,387
	18 60	1860RE	544	544	650	893	1,387	1,005	1,489	1,506
	18 72	1872RE	626	626	742	1,041	1,585	1,159	1,737	1,705
	18 84	1884RE	893	893	984	1,294	1,833	1,458	2,062	1,983
	18 96	1896RE	1,041	1,041	1,122	1,394	2,030	1,568	2,244	2,180
	20 30	2030RE	-	-	-	601	1,023	678	1,154	-
	20 36	2036RE	-	-	-	667	1,109	750	1,250	-
	24 30	2430RE	381	381	465	803	1,129	943	1,269	1,297
	24 36	2436RE	431	431	523	911	1,229	1,027	1,385	1,532
	24 42	2442RE	490	490	569	984	1,334	1,106	1,499	1,870
	24 48	2448RE	551	551	650	1,109	1,499	1,250	1,684	1,966
	24 60	2460RE	660	660	765	1,258	1,700	1,412	1,911	2,405
	24 72	2472RE	761	761	884	1,428	1,934	1,607	2,178	2,843
	24 84	2484RE	1,141	1,141	1,255	1,571	2,427	1,769	2,732	3,164
	24 96	2496RE	1,243	1,243	1,368	1,714	2,638	1,927	2,969	3,484
	30 36	3036RE	511	511	589	1,005	1,351	1,131	1,520	1,831
	30 42	3042RE	573	573	664	1,170	1,560	1,315	1,753	2,260
	30 48	3048RE	637	637	736	1,250	1,673	1,408	1,881	2,364
	30 60	3060RE	778	778	891	1,444	1,927	1,625	2,167	2,886
	30 72	3072RE	898	898	1,034	1,577	2,126	1,777	2,388	3,419
	30 84	3084RE	1,304	1,304	1,419	1,744	2,598	1,961	2,919	3,740
	30 96	3096RE	1,428	1,428	1,554	1,909	2,900	2,147	3,260	4,062
	36 42	3642RE	657	657	758	1,269	1,698	1,430	1,906	2,634
	36 48	3648RE	728	728	835	1,362	1,820	1,532	2,043	2,750
	36 60	3660RE	895	895	1,021	1,546	2,065	1,741	2,324	3,355
	36 72	3672RE	1,038	1,038	1,173	1,770	2,356	1,990	2,652	3,971
	36 84	3684RE	1,467	1,467	1,589	1,952	2,768	2,197	3,114	4,584
	36 96	3696RE	1,611	1,611	1,756	2,137	3,074	2,405	3,456	5,188
	42 72	4272RE	1,186	1,186	1,300	1,884	2,576	2,008	2,738	-
	42 84	4284RE	1,634	1,634	1,756	2,082	2,974	2,496	3,520	-
	42 96	4296RE	1,798	1,798	1,933	2,296	3,369	2,744	3,597	-
	48 96	4896RE	1,991	1,991	2,125	2,620	3,765	3,271	4,126	-
	48 120	48120RE	2,364	2,364	2,534	3,043	4,163	3,806	4,660	-

Continued on next page













# TOP ONLY

Laminate Surface				Wood Surface			
Self Edge	Vinyl Edges	PVC Edges	Wood Edges Group A	Wood Edges Group B	Wood Edges Group A	Wood Edges Group B	Butcher Block
 LLSE Self Edge	 LVFL Flat	 LPVC PVC	 LWFL Flat	 LWSQ Square	 WWFL Flat	 WWSQ Square	 BBFL Flat
	 LVBP Bumper		 LWTP Tapered Ply	 LWBN Bullnose	 WWTP Tapered Ply	 WWBN Bullnose	 BBBN Bullnose
			 LWFP Flat Ply	 LWPR Prism	 WWFP Flat Ply	 WWPR Prism	

## Top Only List Pricing

RD Rectangle	Top Size		Model #	490	490	569	984	1,334	1,106	1,499	1,870
	24	42									
	24	48	2448RR	551	551	650	1,109	1,499	1,250	1,684	1,966
	30	48	3048RR	637	637	736	1,250	1,673	1,408	1,881	2,364
	36	48	3648RR	728	728	835	1,362	1,820	1,532	2,043	2,750

Solid Surface      Quartz Surface

Corian® Group A	Corian® Group B	Quartz Q1	Quartz® Q2
 C1FL Flat	 C2FL Flat	 Q1FL Flat	 Q2FL Flat
 C1BN Bullnose	 C2BN Bullnose	 Q1BN Bullnose	 Q2BN Bullnose
 C1PR Prism	 COPR Pri2m		

1,852	1,929	2,490	4,824
2,068	2,154	-	-
2,505	2,609	-	-
3,566	3,714	-	-

Options

Top Materials and Finishes

Premium Laminates		📞
Custom Wood Veneer	CWV	📞
Stain to Match (set-up charge)	STM	476

Top Options

3" Radius Corner (per corner) (Laminate self edge & Corian®)	CRL3	40
3" Wood Radius Corner (per corner) (not available in LWFL, WWFL, LWPI and WWPI)	CRW3	95
Custom Radius Corner	CRC	95
Custom Size	CS	📞
Custom Shape	CSH	📞

Edge Options

1.75" Thick Edge (see edge details for specific profiles)	175E	5% (per table)
--	------	----------------

📞 Call for pricing

415.621.6656



# Options Pricing

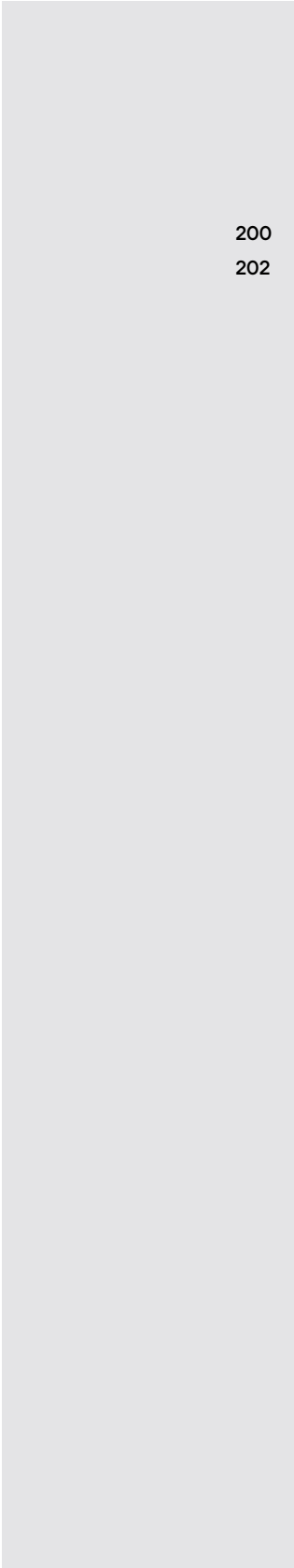

200 Options Pricing  
202 Power & Data

# OPTIONS PRICING

## Base Options

**AH** **Alternate Height Base** **76**

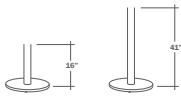

WCI table bases are available in a custom height within the range of 16" – 41" (per column). Alternate height Florentine bases are 174.

**GSL** **Super Level Glides** **40**



Overall height of .75" is recommended for use on uneven or hard surface floors. Eliminates table wobble by automatically self-leveling. Adjusts up to .25" of wobble. Super level glides will not affect the overall height of the table. Super Level Glides are not available on Blok, Disc, Kone or Platform series. Sold in set of 5 (per base).

**TMX/TMT** **Tilt-top with Standard Cable Release** **X-base 312**  
**T-base 483**

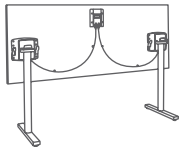

For use on table bases with up to a 2.5" column diameter. The cable release mechanism activates both mechanisms on a table with two single column T-bases. It is not available on TT bases or Post Leg.

**TWC2** **Casters 2" Twin Wheel** **65**



Twin Wheel Casters are 2" diameter black nylon with a black nylon hood and locking tab. Casters will not affect the overall height of the table. Casters are available on Dunhill, Mark IV, Plus, Post Leg, Slimline and Tuscan series. Sold in set of 4.

**FM** **Folding Mechanism** **T-base 312**

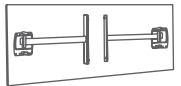

Folding table mechanism must be activated individually. The folding mechanism is available on Dunhill, Mark IV, Plus, Slimline and Tuscan T-bases only. It is not available on TT bases or Post Leg. For use on tables bases with up to a 2.5" column diameter.

**MWC3** **Casters 3" Mag Wheel** **193**



Mag Wheel Casters are 3" diameter, single wheel, black polyurethane, with a spoked cast iron core, black chrome plated fork finish and a top locking tab. Casters will not affect the overall height of the table. Casters are available on Vista tables series only. Not Available on Vista with Quartz tops. Sold in set of 4.

## Wall Cleats and Cantilever

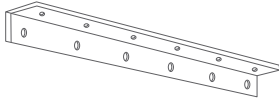
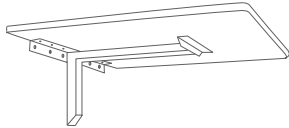
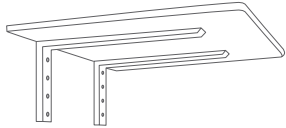

	Size	Maximum Top Size	Model #	
<b>Wall Cleat</b>	20	36" wide	WC20	54
				
<b>Cantilever Table Bracket Single</b>	16 21	30" x 36"	CTBS21	199
	16 33	30" x 48"	CTBS33	248
				
<b>Cantilever Table Bracket Double</b>	12 12	24" x 24"	CTBD12	187
	16 18	30" x 24"	CTBD18	219
	16 24	30" x 30"	CTBD24	252
	16 30	36" x 36"	CTBD30	285
	16 36	36" x 42"	CTBD36	318
	16 42	36" x 48"	CTBD42	352
				

# OPTIONS PRICING



## Top Options

<b>CS &amp; CSH</b>	<b>Custom Size/Shape</b>	<b>1</b>
	WCI can manufacture many different size and shape tops; please call customer service 844-815-2217 for more information	
<b>CET</b>	<b>Custom Edge Thickness</b>	<b>1</b>
	WCI can manufacture specific customer edge thickness; please call customer service 844-815-2217 for more information	
<b>CRC</b>	<b>Custom Radius Corner</b>	<b>95</b>
	WCI can manufacture specific custom radius corners; please call customer service 844-815-2217 for more information	
<b>CRL3</b>	<b>3" Radius Corner</b>	<b>40</b>
	3" Radius corners are available on laminate tops with a self-edge, also available on Ultrafoam and Corian® tops. (per corner)	
<b>CRW3</b>	<b>3" Wood Radius Corner</b>	<b>95</b>
	3" Radius corners are available on laminate tops with wood edges. Not available in LWFL, WWFL, LWPI, WWPI (per corner)	
<b>UMB</b>	<b>2" Umbrella Hole</b>	<b>286</b>
	Available on Outdoor Basic Round, Bistro, Flat Round, Disc, Park and Platform tables only (per table).	

## Grommets

<b>GMBM, GMSC &amp; GMPC</b>	<b>2" Round Metal Grommet</b>	<b>160</b>
	Matte black (GMBM), Satin chrome (GMSC) Polished chrome (GMPC)	
<b>GPMBM</b>	<b>2" Round Plastic Grommet</b>	<b>51</b>
	Matte black (GPMBM)	

## Wire Management

<b>WMJ</b>	<b>Black Plastic J-Trough 48" long</b>	<b>134</b>
	Under table mounted J-trough provides concealed cable management. Matte black plastic, attachment hardware not included.	
<b>WML</b>	<b>Legway Wire Manager 26"</b>	<b>65</b>
	Vertical trough provides concealed cable management. Matte black plastic, attachment adhesive included.	

## Ganging Clips

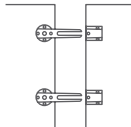
<b>GC</b>	<b>Ganging Clips</b>	<b>171</b>
	Connects two table tops for use as one large table. Friction and bolt release allows for quick separation. Set includes two clips and two brackets. One set is recommended per table side.	

# POWER & DATA OPTIONS

## Node®



The Node's clean, flush mount design complements a wide range of aesthetics. Its design is versatile yet discreet, offering a range of power, data, and USB configurations.

<b>Standard Features:</b>		<b>Canvas only</b>	<b>All Other Tables</b>
Finishes:	Parchment, Black, Silver		
<b>Configurations:</b>			
NOD2-A	2 Power	852	200
NOD2-B	1 Power and 2 USB chargers	936	281
NOD2-C	1 Power and 1 USB-A and 1 USB_C	936	281
<b>Cord Lengths:</b>	72" or 120" (Standard)		

## Tully®



Traditional meeting and collaborative tables aren't the only places people work today. WCI's custom designed banquettes and seating offer comfortable, flexible workspaces which keep you connected. Tully tucks right into those comfortable spaces to keep you powered up. Tully also mounts discreetly under that collaborative worksurface.

<b>Standard Features:</b>		<b>Canvas only</b>	<b>All Other Tables</b>
Finishes:	White Plastic w/ Silver Braided Cord, Black Plastic w/ Gunmetal Braided Cord		
<b>Configurations:</b>			
TUL3	1 Power and 2 USB-A and 1 USB-C (9" or 2" tail)	1,074	416
<b>Cord Lengths:</b>	120" Braided Cord (Standard)		
	ETL Listed		

## Mini-Tap®



The Mini-Tap Power provides 2 outlets with key slots, allowing the power to be placed near the edge of the worksurface. A great option to avoid cutting into the surface, and offering easy access to power.

<b>Standard Features:</b>		<b>Canvas only</b>	<b>All Other Tables</b>
Finishes:	Black only		
<b>Configurations:</b>			
MIN2-A	2 Power	787	132
MIN2-B	1 Power and 1 USB-A	884	229
<b>Cord Lengths:</b>	72" or 120" (Standard)		
	Assembly required		

Node®, Tully®, Mini-Tap®, Ellora® B, Double Ellora® B, and MS2 — BYRNE electric.  
Customer may specify alternate power and data modules. Modules must be approved by WCI engineering.

**Ellora® B**

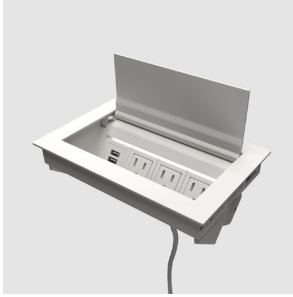

Ellora B manages power and data with ease. With its clean powder coated finish and seamless, one-piece aluminum frame, the design is contemporary and understated. When in use, the lid opens for easy access at the work surface but closes softly to hide cable clutter out of sight.

<b>Standard Features:</b>		<b>Canvas only</b>	<b>All Other Tables</b>
<b>Finishes:</b>	Matte White, Matte Fog, Matte Storm		
<b>Configurations:</b>			
SEL4-A	3 Power and 1 USB	1,106	450
SEL4-B	2 Power and 2 USB	1,203	531
SEL4-C	4 Power	1,106	450
<b>Cord Lengths:</b>	72" or 120" (Standard)		
UL Listed			

**Double Ellora® B**

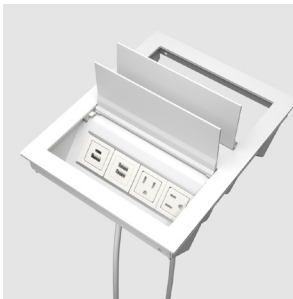

Double Ellora B offers the same seamless in-surface design as the classic Ellora B maintaining the same contemporary and understated design. The same scalable power and data options are available—but doubled—so it can deliver easy access from both sides of the table.

<b>Standard Features:</b>		<b>Canvas only</b>	<b>All Other Tables</b>
<b>Finishes:</b>	Matte White, Matte Fog, Matte Storm		
<b>Configurations:</b>			
DEL4-A	2 Power and 1 USB charger and 1 USB A+C (each side)	1,709	1,053
DEL4-B	4 Power	1,454	861
<b>Cord Lengths:</b>	72" or 120" (Standard)		
UL Listed			

**MS2**



MS2 is a side-by-side solution for conference tables that provides access to power and data from both sides or one side. Thanks to its one-touch access in a streamlined design, MS2 power and data is totally concealable. MS2 can be customized with a full line of technology accessories.

<b>Standard Features:</b>		<b>Canvas only</b>	<b>All Other Tables</b>
<b>Finishes:</b>	Silver Anodized Aluminum Black Anodized Aluminum		
<b>Configurations:</b>			
MS24-A	2 Power and 1 USB charger and 1 USB A+C (each side) Silver Anodized Aluminum	1,709	1,053
MS24-B	2 Power and 1 USB charger and 1 USB A+C (each side) Black Anodized Aluminum	1,454	861
<b>Cord Lengths:</b>	72" or 120" (Standard)		
UL Listed	72' Hard wired (Anodized Aluminum Only)		

Includes a Voice/Data Adapter Kit (BE01421) to accept couplers & jacks when required  
Configurations with four or more power receive a Circuit Breaker Cord

W	C
---	---